

# Agilent 4338B Milliohm meter Operation Manual

## Manual Change

Agilent Part No. N/A

Jun 2009

### Change 1

Add TAR in Test Signal Frequency Accuracy Test (Page 9-10) to the following.

Test Signal Frequency [Hz]	Test Limits [Hz]	Test Result	Measurement Uncertainty [Hz]	TAR
1 k	±1		± 0.000018 k	57

### Change 2

Add TAR in Resistance Measurement Accuracy Test (Page 9-10) to the following.

Standard [ohm]	Test Signal Current [A]	Test Limits [ohm]	Test Result [ohm]	Measurement Uncertainty [ohm]	TAR
1 m	10 m	±0.024 m		±0.0081 m	2.9
10 m	10 m	±0.054 m		±0.025 m	2.2
100 m	1 m	±0.45 m		±0.18 m	2.6
1	10 m	±0.0043		±0.0020	2.1
10	10 μ	±0.044		±0.017	2.6
100	1 μ	±0.49		±0.15	3.3
1 k	10 μ	±9.3		±0.0019 k	5.0
10 k	1 μ	±540		±0.025 k	21.9

# Agilent 4338B Milliohmmeter Operation Manual

## Manual Change

Agilent Part No. N/A

July 2008

### Change 1

Change the Measurement Uncertainty value of Test Signal Frequency Accuracy Test (Page 9-10) to the following.

Test Signal Frequency [Hz]	Test Limits [Hz]	Test Result	Measurement Uncertainty [Hz]
1 k	±1		± 0.000018 k

### Change 2

Change the Measurement Uncertainty value of Resistance Measurement Accuracy Test (Page 9-10) to the following.

Standard [ohm]	Test Signal Current [A]	Test Limits [ohm]	Test Result [ohm]	Measurement Uncertainty [ohm]
1 m	10 m	±0.024 m		±0.0081 m
10 m	10 m	±0.054 m		±0.025 m
100 m	1 m	±0.45 m		±0.18 m
1	10 m	±0.0043		±0.00020
10	10 μ	±0.044		±0.017
100	1 μ	±0.49		±0.15
1 k	10 μ	±9.3		±0.0019 k
10 k	1 μ	±540		±0.025 k

# Agilent 4338B Milliohmmeter Operation Manual

## Manual Change

Agilent Part No. N/A

June 2007

### Change 1

Add the following note to the “3-c. Turning ON the 4338B” (page 1-13).

#### Note

In case the setting of the ac line frequency is not match, there's any possibility the measurement error will rise. Make sure the ac line frequency has been set up correctly.

### Change 2

Add the following condition to the “Measurement Accuracy” (page 8-3).

3. The ac line frequency has been set up correctly.

# マニュアル チェンジ

## 変更 1

4338B の電源投入の手順 3-c (ページ 1-10) に以下の注記を追加して下さい。

## 注記

AC 電源周波数の設定値が一致していない場合、測定誤差が増大する可能性があります。必ず AC 電源周波数を正しく設定して下さい。

## 変更 2

測定確度の条件 (ページ 8-3) に以下の条件を追加して下さい。

3. AC 電源周波数が正しく設定されている。



## DECLARATION OF CONFORMITY

According to ISO/IEC Guide 22 and CEN/CENELEC EN 45014

**Manufacturer's Name:** Agilent Technologies Japan, Ltd.

**Manufacturer's Address:** 1-3-2, Murotani, Nishi-ku, Kobe-shi,  
Hyogo, 651-2241 Japan

Declares, that the product:

**Product Name:** Milliohm Meter

**Model Number:** 4338B

**Product Options:** This declaration covers all options of the above product

Conforms with the following product standards:

EMC:	Standard	Limit
	IEC 61326-1:1997 +A1:1998 / EN 61326-1:1997 +A1:1998	
	CISPR 11:1997 / EN 55011:1998 / AS/NZS 2064.1/2	Group 1, Class A <sup>(1)</sup>
	IEC 61000-4-2:1995 / EN 61000-4-2:1995 +A1:1998	4 kV CD, 4 kV AD
	IEC 61000-4-3:1995 / EN 61000-4-3:1996 +A1:1998	3 V/m 80% AM 80 - 1000 MHz
	IEC 61000-4-4:1995 / EN 61000-4-4:1995	0.5 kV signal lines, 1 kV power lines
	IEC 61000-4-5:1995 / EN 61000-4-5:1995	0.5 kV line-line, 1 kV line-ground
	IEC 61000-4-6:1996 / EN 61000-4-6:1996	3 V 80% AM 0.15 - 80 MHz
	IEC 61000-4-11:1994 / EN 61000-4-11:1994	1 cycle, 100%
	Canada: ICES-001	
Safety:	IEC 61010-1:1990 +A1:1992 +A2:1995 / EN 61010-1:1993 +A2:1995	
	CAN / CSA C22.2 No. 1010.1-92	

### Conformity / Supplementary Information:

The product herewith complies with the requirements of the Low Voltage Directive 73/23/EEC and the EMC Directive 89/336/EEC (including 93/68/EEC) and carries the CE-marking accordingly (European Union).

LEDs in this product are Class 1 in accordance with EN 60825-1:1994.

<sup>(1)</sup> The product was tested in a typical configuration with Agilent Technologies test systems.

Kobe, Japan      Dec. 15, 2000  
Date

  
Name Koichi Yanagawa / Quality Engineering Manager

For further information, please contact your local Agilent Technologies sales office, agent or distributor.



---

## **Safety Summary**

---

When you notice any of the unusual conditions listed below, immediately terminate operation and disconnect the power cable.

Contact your local Agilent Technologies sales representative or authorized service company for repair of the instrument. If you continue to operate without repairing the instrument, there is a potential fire or shock hazard for the operator.

- Instrument operates abnormally.
- Instrument emits abnormal noise, smell, smoke or a spark-like light during the operation.
- Instrument generates high temperature or electrical shock during operation.
- Power cable, plug, or receptacle on instrument is damaged.
- Foreign substance or liquid has fallen into the instrument.





---

## **Herstellerbescheinigung**

### GERÄUSCHEMISSION

LpA < 70 dB  
am Arbeitsplatz  
normaler Betrieb  
nach DIN 45635 T. 19

---

## **Manufacturer's Declaration**

### ACOUSTIC NOISE EMISSION

LpA < 70 dB  
operator position  
normal operation  
per ISO 7779



---

## **Caution**

---

Do not apply DC voltage exceeding  $\pm 42\text{V}$  to the UNKNOWN terminals, or input circuit of the 4338B will be destroyed.



# Agilent 4338B Milliohmmeter Operation Manual

## **SERIAL NUMBERS**

This manual applies directly to instruments with serial number prefix JP1KD, or firmware revision 1.01. For additional important information about serial numbers, read “Serial Number” in Appendix A.



**Agilent Part No. 04338-90040  
Printed in Japan March 2003**

**Seventh Edition**

---

## **Notice**

The information contained in this document is subject to change without notice.

This document contains proprietary information that is protected by copyright. All rights are reserved. No part of this document may be photocopied, reproduced, or translated to another language without the prior written consent of the Agilent Technologies.

Agilent Technologies Japan, Ltd.  
Component Test PGU-Kobe  
1-3-2, Murotani, Nishi-ku, Kobe-shi,  
Hyogo, 651-2241 Japan

## Manual Printing History

The manual's printing date and part number indicate its current edition. The printing date changes when a new edition is printed. (Minor corrections and updates that are incorporated at reprint do not cause the date to change.) The manual part number changes when extensive technical changes are incorporated.

March 1996 .....	First Edition (part number: 04338-90010)
April 1997 .....	Second Edition (part number: 04338-90020)
June 1998 .....	Third Edition (part number: 04338-90030)
January 2000 .....	Fourth Edition (part number: 04338-90030)
January 2001 .....	Fifth Edition (part number: 04338-90030)
September 2002 .....	Sixth Edition (part number: 04338-90030)
March 2003 .....	Seventh Edition (part number: 04338-90040)



---

## Safety Summary

The following general safety precautions must be observed during all phases of operation, service, and repair of this instrument. Failure to comply with these precautions or with specific *WARNINGS* elsewhere in this manual may impair the protection provided by the equipment. In addition it violates safety standards of design, manufacture, and intended use of the instrument.

*The Agilent Technologies assumes no liability for the customer's failure to comply with these requirements.*

---

**Note** 4338B comply with INSTALLATION CATEGORY II and POLLUTION DEGREE 2 in IEC1010-1. 4338B are INDOOR USE product.



---

**Note** LEDs in 4338B are Class 1 in accordance with IEC825-1.  
CLASS 1 LED PRODUCT



---

### Ground The Instrument

To avoid electric shock hazard, the instrument chassis and cabinet must be connected to a safety earth ground by the supplied power cable with earth blade.

### DO NOT Operate In An Explosive Atmosphere

Do not operate the instrument in the presence of flammable gasses or fumes. Operation of any electrical instrument in such an environment constitutes a definite safety hazard.

### Keep Away From Live Circuits

Operating personnel must not remove instrument covers. Component replacement and internal adjustments must be made by qualified maintenance personnel. Do not replace components with the power cable connected. Under certain conditions, dangerous voltages may exist even with the power cable removed. To avoid injuries, always disconnect power and discharge circuits before touching them.

### DO NOT Service Or Adjust Alone

Do not attempt internal service or adjustment unless another person, capable of rendering first aid and resuscitation, is present.

### DO NOT Substitute Parts Or Modify Instrument

Because of the danger of introducing additional hazards, do not install substitute parts or perform unauthorized modifications to the instrument. Return the instrument to a Agilent Technologies Sales and Service Office for service and repair to ensure that safety features are maintained.

## Dangerous Procedure Warnings

**Warnings**, such as the example below, precede potentially dangerous procedures throughout this manual. Instructions contained in the warnings must be followed.

---

<b>Warning</b>	<b>Dangerous voltages, capable of causing death, are present in this instrument. Use extreme caution when handling, testing, and adjusting this instrument.</b>
	

---

## Safety Symbols

General definitions of safety symbols used on equipment or in manuals are listed below.



Instruction manual symbol: the product is marked with this symbol when it is necessary for the user to refer to the instruction manual.



Alternating current.



Direct current.



On (Supply).



Off (Supply).



In position of push-button switch.



Out position of push-button switch.



Frame (or chassis) terminal. A connection to the frame (chassis) of the equipment which normally include all exposed metal structures.

### Warning



This **Warning** sign denotes a hazard. It calls attention to a procedure, practice, condition or the like, which, if not correctly performed or adhered to, could result in injury or death to personnel.

### Caution



This **Caution** sign denotes a hazard. It calls attention to a procedure, practice, condition or the like, which, if not correctly performed or adhered to, could result in damage to or destruction of part or all of the product.

### Note



This **Note** sign denotes important information. It calls attention to a procedure, practice, condition or the like, which is essential to highlight.



Affixed to product containing static sensitive devices use anti-static handling procedures to prevent electrostatic discharge damage to component.

---

## Certification

Agilent Technologies certifies that this product met its published specifications at the time of shipment from the factory. Agilent Technologies further certifies that its calibration measurements are traceable to the United States National Institute of Standards and Technology, to the extent allowed by the Institution's calibration facility, or to the calibration facilities of other International Standards Organization members.

---

## Warranty

This Agilent Technologies instrument product is warranted against defects in material and workmanship for a period of one year from the date of shipment, except that in the case of certain components listed in *General Information* of this manual, the warranty shall be for the specified period. During the warranty period, Agilent Technologies will, at its option, either repair or replace products that prove to be defective.

For warranty service or repair, this product must be returned to a service facility designated by Agilent Technologies. Buyer shall prepay shipping charges to Agilent Technologies and Agilent Technologies shall pay shipping charges to return the product to Buyer. However, Buyer shall pay all shipping charges, duties, and taxes for products returned to Agilent Technologies from another country.

Agilent Technologies warrants that its software and firmware designated by Agilent Technologies for use with an instrument will execute its programming instruction when properly installed on that instrument. Agilent Technologies does not warrant that the operation of the instrument, or software, or firmware will be uninterrupted or error free.

---

## Limitation Of Warranty

The foregoing warranty shall not apply to defects resulting from improper or inadequate maintenance by Buyer, Buyer-supplied software or interfacing, unauthorized modification or misuse, operation outside the environmental specifications for the product, or improper site preparation or maintenance.

*No other warranty is expressed or implied. Agilent Technologies specifically disclaims the implied warranties of merchantability and fitness for a particular purpose.*

## **Exclusive Remedies**

*The remedies provided herein are buyer's sole and exclusive remedies. Agilent Technologies shall not be liable for any direct, indirect, special, incidental, or consequential damages, whether based on contract, tort, or any other legal theory.*

---

## **Assistance**

Product maintenance agreements and other customer assistance agreements are available for Agilent Technologies products.

For any assistance, contact your nearest Agilent Technologies Sales and Service Office. Addresses are provided at the back of this manual.

---

## Typeface Conventions

**Bold** Boldface type is used when a term is defined. For example: **icons** are symbols.

*Italics* Italic type is used for emphasis and for titles of manuals and other publications.

Italic type is also used for keyboard entries when a name or a variable must be typed in place of the words in italics. For example: copy *filename* means to type the word *copy*, to type a space, and then to type the name of a file such as *file1*.

Computer Computer font is used for on-screen prompts and messages.



**HARDKEYS** Labeled keys on the instrument front panel are enclosed in **□**.



















**SOFTKEYS** Softkeys located to the right of the CRT are enclosed in **▣**.





















# Contents

---

## 1. Getting Started

Introduction . . . . .	1-1
Overview . . . . .	1-2
Features . . . . .	1-2
Accessories Available . . . . .	1-3
Front Panel . . . . .	1-4
Display . . . . .	1-7
Rear Panel . . . . .	1-8
Incoming Inspection . . . . .	1-9
Providing clearance to dissipate heat at installation site . . . . .	1-9
Instruction for Cleaning . . . . .	1-9
Power Cable . . . . .	1-10
Preparation for Use . . . . .	1-12
Power Requirements . . . . .	1-12
 Fuse . . . . .	1-12
Turning ON the 4338B . . . . .	1-13
Using Front-Panel Keys . . . . .	1-14
Direct Execution Keys . . . . .	1-14
Toggle Keys . . . . .	1-14
Selection Keys . . . . .	1-14
Value Setup Keys . . . . .	1-15
Numeric Keys . . . . .	1-15
Maximum and Minimum Keys . . . . .	1-16
Left/Down and Right/Up Arrow Keys . . . . .	1-17
Back Space Key . . . . .	1-17
 To Perform a Measurement . . . . .	1-18
Connecting a Test Fixture . . . . .	1-19
Using the 16338A . . . . .	1-19
To Reset 4338B . . . . .	1-20
To Perform a SHORT Correction . . . . .	1-20
To Select Measurement Parameter . . . . .	1-22
To Select Auto Measurement Mode . . . . .	1-22
To Select Test Signal Level . . . . .	1-22
To Select Measurement Range . . . . .	1-23
Auto / Hold Range Mode . . . . .	1-23
Measurement Range Setting . . . . .	1-23

<b>2. Operating the 4338B</b>	
Introduction . . . . .	2-1
Measurement Configuration . . . . .	2-2
To Select the Measurement Time Mode . . . . .	2-2
To Set the Averaging Rate . . . . .	2-2
To Set the Trigger Delay or Source Delay Time . . . . .	2-2
To Set the Contact Check . . . . .	2-3
To Set the Beeper Mode . . . . .	2-4
To Save and Recall Instrument Settings . . . . .	2-4
Making a Measurement . . . . .	2-6
To Trigger a Measurement . . . . .	2-6
To Use the Comparator Function . . . . .	2-7
To Display Deviation Data . . . . .	2-8
To Set the Reference Value . . . . .	2-8
To Select the Deviation Display Mode . . . . .	2-9
To Set the Display Mode and Display Digits . . . . .	2-10
To Change the Measurement Settings Display Mode . . . . .	2-11
To Lock Out the Front Panel Keys . . . . .	2-12
To Select the Local Mode . . . . .	2-12
To Set the GPIB Address . . . . .	2-12
To Print Measurement Data . . . . .	2-12
To Test the 4338B . . . . .	2-13
To Perform a Self-Test . . . . .	2-13
To Test the Front Panel Keys' Functionality . . . . .	2-13
If You Have a Problem . . . . .	2-14
If the Display is Blank and the 4338B Appears Dead . . . . .	2-14
If an Error Message is Displayed . . . . .	2-14
If the 4338B does not Accept Any Key Input . . . . .	2-14
<b>3. Function Reference</b>	
Introduction . . . . .	3-1
Front Panel . . . . .	3-2
Display . . . . .	3-2
LINE Switch . . . . .	3-3
Chassis Terminal . . . . .	3-3
 UNKNOWN Terminals . . . . .	3-3
Auto Measurement Key  . . . . .	3-3
Level Key  . . . . .	3-4
Measurement Parameter Key  . . . . .	3-5
Deviation Mode Key   . . . . .	3-5
Measurement Time Key  . . . . .	3-5
Show Setting Key  . . . . .	3-5
Display Mode Key   . . . . .	3-6
Average Key  . . . . .	3-6
Auto / Hold range Key  . . . . .	3-6
Range Setup Key   . . . . .	3-6
Trigger Key  . . . . .	3-6
Trigger Mode Key  . . . . .	3-7
Delay Key   . . . . .	3-7

Local Key 	3-8
Address Key 	3-8
Save Key 	3-8
Recall Key 	3-9
Primary and Secondary comparator limit Key 	3-9
Left/Down Arrow Key and Right/Up Arrow Key 	3-9
0, 1, . . . , 9, -(minus), .(point) Key 	3-9
Enter Key 	3-9
BLUE Shift Key 	3-9
Engineering units Key 	3-10
Back Space Key 	3-10
Minimum Key 	3-10
Maximum Key 	3-10
Comparator Key 	3-10
Contact Check Key 	3-11
Short Key 	3-11
Key Lock Key 	3-11
Reset Key 	3-12
Configuration Key 	3-12
Rear Panel . . . . .	3-14
External Trigger . . . . .	3-14
 LINE Fuse Holder . . . . .	3-15
LINE Voltage Selector . . . . .	3-15
Serial Number Plate . . . . .	3-15
Power Cord Receptacle . . . . .	3-15
Power Code . . . . .	3-15
Handler Interface . . . . .	3-16
Specification . . . . .	3-16
GPIB Interface . . . . .	3-18
Theory of Operation . . . . .	3-20
Overall Measurement Theory . . . . .	3-20
Test Signal Level . . . . .	3-22
Actual Signal Level across DUT . . . . .	3-22
Limitation of Test Level . . . . .	3-22
<b>4. Remote Operation</b>	
Introduction . . . . .	4-1
Getting Started . . . . .	4-2
Input/Output Statements . . . . .	4-2
Reading the GPIB Address . . . . .	4-2
Sending a Remote Command . . . . .	4-2
Returning to the Local Mode . . . . .	4-3
Query Commands . . . . .	4-3
Getting Data from the 4338B . . . . .	4-3
To Control the 4338B from an External Computer . . . . .	4-4
To Set Up the 4338B . . . . .	4-5
To Reset the 4338B . . . . .	4-5



To Set the LINE Frequency . . . . .	4-5
To Perform the SHORT Correction . . . . .	4-5
To Select the Measurement Parameter . . . . .	4-5
To Select the Auto Measurement Mode . . . . .	4-6
To Select the Measurement Range . . . . .	4-6
To Select the Test Signal Level . . . . .	4-6
To Set the Measurement Time Mode . . . . .	4-6
To Set the Averaging Rate . . . . .	4-7
To Set the Delay Time . . . . .	4-7
To Set the Beeper Mode . . . . .	4-7
To Use Comparator Function . . . . .	4-8
To Display a Deviation Measurement . . . . .	4-8
To Wait Until Previously Sent Commands are Completed . . . . .	4-8
To Get the Current Instrument Settings . . . . .	4-9
To Save and Recall Instrument Settings . . . . .	4-9
To Trigger a Measurement . . . . .	4-10
Waiting For Completion Of Measurement (detecting completion of measurement)	4-11
Sample program . . . . .	4-12
Reading Out Measured Result . . . . .	4-13
Reading out measured result using *TRG command . . . . .	4-14
Reading out measured result using :FETC? command . . . . .	4-18
To Retrieve Data Efficiently . . . . .	4-22
To Use a Data Buffer . . . . .	4-22
Other Features . . . . .	4-23
To test the 4338B . . . . .	4-23
To Report the Instrument's Status . . . . .	4-23
If You Have a Problem . . . . .	4-25
If the 4338B Hangs Up When You Send ABORt Command . . . . .	4-25

## 5. GPIB Reference

Introduction . . . . .	5-1
GPIB Commands . . . . .	5-1
Common Commands . . . . .	5-1
Subsystem Commands . . . . .	5-1
Subsystem Command Tree . . . . .	5-4
Program Message Syntax . . . . .	5-5
Case . . . . .	5-5
Program Message Terminator . . . . .	5-5
Subsystem Command Syntax . . . . .	5-5
Common Command Syntax . . . . .	5-5
Parameters . . . . .	5-5
Parameter Types . . . . .	5-5
Suffix . . . . .	5-6
Multiple Messages . . . . .	5-7
Query and Response Message Syntax . . . . .	5-7
Command Reference . . . . .	5-8
Notations . . . . .	5-8
ABORt Command . . . . .	5-9
:ABORt . . . . .	5-9
CALCulate Subsystem . . . . .	5-10
:CALCulate1:FORMat { REAL   MLINear }	
:CALCulate2:FORMat { NONE   IMAGnary   PHASe   LS }	5-11
:CALCulate{1 2}:LIMit:BEEPPer:CONDition { FAIL   PASS }	5-11
:CALCulate{1 2}:LIMit:BEEPPer[:STATe] { ON   OFF   1   0 }	5-12
:CALCulate{1 2}:LIMit:CLEar . . . . .	5-12

:CALCulate{1 2}:LIMit:FAIL?	5-12
:CALCulate{1 2}:LIMit:LOWer[:DATA] <numeric_value>	5-12
:CALCulate{1 2}:LIMit:LOWer:STATe { ON   OFF   1   0 }	5-13
:CALCulate{1 2}:LIMit:STATe { ON   OFF   1   0 }	5-13
:CALCulate{1 2}:LIMit:UPPer[:DATA] <numeric_value>	5-13
:CALCulate{1 2}:LIMit:UPPer:STATe { ON   OFF   1   0 }	5-13
:CALCulate{1 2}:MATH:EXPRession:CATalog?	5-13
:CALCulate{1 2}:MATH:EXPRession:NAME { DEV   PCNT }	5-14
:CALCulate{1 2}:MATH:STATe { ON   OFF   1   0 }	5-14
:CALCulate{1 2}:PATH?	5-14
DATA Subsystem	5-15
:DATA[:DATA] { REF1   REF2 },<numeric_value>	5-15
:DATA[:DATA]? { BUF1   BUF2 }	5-16
:DATA:FEED { BUF1   BUF2 },<data_handle>	5-16
:DATA:FEED:CONTRol { BUF1   BUF2 },{ ALWAYS   NEVER }	5-17
:DATA:POINTs { BUF1   BUF2 },<numeric_value>	5-17
DISPlay Subsystem	5-18
:DISPlay[:WINDow][:STATe] { ON   OFF   1   0 }	5-18
:DISPlay[:WINDow]:TEXT1:DIGit {3 4 5}	5-18
:DISPlay[:WINDow]:TEXT1:PAGE { 1   2 }	5-18
:DISPlay[:WINDow]:TEXT2:PAGE {1 2 3 4}	5-18
FETCH? Query	5-19
:FETCh?	5-19
FORMat Subsystem	5-20
:FORMat[:DATA] { ASCii   REAL[,64] }	5-20
INITiate Subsystem	5-21
:INITiate[:IMMediate]	5-21
:INITiate:CONTInuous { ON   OFF   1   0 }	5-21
SENSe Subsystem	5-22
[:SENSe]:AVERage:COUNt <numeric_value>	5-22
[:SENSe]:AVERage[:STATe] { ON   OFF   1   0 }	5-22
[:SENSe]:CORRection:COLLect[:ACQuire] STANdard2	5-22
[:SENSe]:CORRection:COLLect:METHod REFL1	5-23
[:SENSe]:CORRection:DATA? STANdard2	5-23
[:SENSe]:CORRection[:STATe] { ON   OFF   1   0 }	5-23
[:SENSe]:FIMPedance:APERture <numeric_value>[MS S]	5-23
[:SENSe]:FIMPedance:CONtact:VERify {ON OFF 1 0}	5-24
[:SENSe]:FIMPedance:RANGe:AUTO { ON   OFF   1   0 }	5-24
[:SENSe]:FIMPedance:RANGe[:UPPer] <numeric_value>[MOHM OHM KOHM]	5-24
[:SENSe]:FUNctIon <sensor_function>	5-24
SOURce Subsystem	5-25
:SOURce:CURRent[:LEVel][:IMMediate][:AMPLitude] <numeric_value>[UA MA]	5-25
:SOURce:CURRent[:LEVel][:IMMediate][:AMPLitude]:AUTO { ON   OFF   1   0 }	5-25
STATus Subsystem	5-26
:STATus:OPERation[:EVENT]?	5-26
:STATus:OPERation:CONDition?	5-26
:STATus:OPERation:ENABle <numeric_value>	5-26
:STATus:PRESet	5-27
:STATus:QUESTionable[:EVENT]?	5-27
:STATus:QUESTionable:CONDition?	5-27
:STATus:QUESTionable:ENABle <numeric_value>	5-27
SYSTem Subsystem	5-28
:SYSTem:BEEPer[:IMMediate]	5-28
:SYSTem:BEEPer:STATe { ON   OFF   1   0 }	5-28
:SYSTem:ERRor?	5-28

:SYSTem:KLOCK { ON   OFF   1   0 }	5-28
:SYSTem:LFRequency <numeric_value>	5-28
:SYSTem:PRESet	5-29
:SYSTem:VERSion?	5-29
TRIGger Subsystem	5-30
:TRIGger[:SEQuence1]:DELay <numeric_value>[MS S]	5-30
:TRIGger[:SEQuence1][:IMMediate]	5-30
:TRIGger[:SEQuence1]:SOURce { BUS   EXTernal   INTernal   MANual }	5-30
:TRIGger:SEQuence2:DELay <numeric_value>[MS S]	5-30
Common Commands	5-31
*CLS	5-31
*ESE <numeric_value>	5-31
*ESE?	5-31
*ESR?	5-31
*IDN?	5-31
*LRN?	5-31
*OPC	5-31
*OPC?	5-32
*OPT?	5-32
*RCL <numeric_value>	5-32
*RST	5-32
*SAV <numeric_value>	5-32
*SRE <numeric_value>	5-32
*SRE?	5-32
*STB?	5-33
*TRG	5-33
*TST?	5-33
*WAI	5-33
Status Reporting Structure	5-34
Service Request (SRQ)	5-34
Status Byte Register	5-35
Standard Event Status Register	5-36
Standard Operation Status Group	5-37
Operation Status Register	5-38
Questionable Status Register	5-38
Trigger System	5-39
4338B Trigger System Configuration	5-39
Idle State	5-39
Initiate State	5-40
Event Detection State	5-40
Sequence Operation State	5-40
Data Transfer Format	5-41
ASCII Format	5-41
REAL Format	5-42

## 6. Application Measurement

Introduction	6-1
Measuring Contact Resistance of Relays or Switches	6-2
 Measuring Internal Resistance of Batteries	6-5

<b>7. Measurement Basics</b>	
Introduction . . . . .	7-1
SHORT Correction . . . . .	7-1
Measurement Range . . . . .	7-2
Dry Circuit Loop . . . . .	7-2
Extending Test Leads . . . . .	7-3
<b>8. General Information</b>	
Introduction . . . . .	8-1
Specifications . . . . .	8-2
Measurement Parameter . . . . .	8-2
Measurement Conditions . . . . .	8-2
Measurement Range . . . . .	8-2
Measurement Accuracy . . . . .	8-3
Measurement Support Functions . . . . .	8-5
General . . . . .	8-6
Supplemental Performance Characteristics . . . . .	8-7
<b>9. Maintenance</b>	
Introduction . . . . .	9-1
Test Equipment . . . . .	9-1
Performance Tests . . . . .	9-2
Introduction . . . . .	9-2
Test Equipment . . . . .	9-2
Calculation Sheet . . . . .	9-2
Performance Test Record . . . . .	9-3
Calibration Cycle . . . . .	9-3
Test Signal Frequency Accuracy Test . . . . .	9-4
Specification . . . . .	9-4
Test Equipment . . . . .	9-4
Procedure . . . . .	9-4
Resistance Measurement Accuracy Test . . . . .	9-6
Specification . . . . .	9-6
Test Equipment . . . . .	9-6
Procedure . . . . .	9-6
Calculation Sheet . . . . .	9-9
Test Signal Frequency Accuracy Test . . . . .	9-9
Resistance Measurement Accuracy Test . . . . .	9-9
Performance Test Record . . . . .	9-10
Test Signal Frequency Accuracy Test . . . . .	9-10
Resistance Measurement Accuracy Test . . . . .	9-10
Functional Test . . . . .	9-11
Introduction . . . . .	9-11
Test Equipment . . . . .	9-11
Test Signal Level Functional Test . . . . .	9-12
Test Equipment . . . . .	9-12
Procedure . . . . .	9-12
Handler Interface Functional Test . . . . .	9-14
Test Equipment . . . . .	9-14
Procedure . . . . .	9-14
Initial Setup . . . . .	9-14
Key Lock Function Test . . . . .	9-14
External Trigger Function Test . . . . .	9-14
Handler Interface Output Test . . . . .	9-15
Functional Test Record . . . . .	9-16

Test Signal Level Functional Test . . . . .	9-16
<b>A. Manual Changes</b>	
Introduction . . . . .	A-1
Manual Changes . . . . .	A-1
Change 1 . . . . .	A-2
Serial Number . . . . .	A-3
<b>B. Handler Interface Installation</b>	
Introduction . . . . .	B-1
Electrical Characteristics . . . . .	B-1
Output Signals . . . . .	B-1
Input Signals . . . . .	B-4
Setting Up the Handler Interface Board . . . . .	B-5
Tools and Fasteners . . . . .	B-5
Procedure . . . . .	B-5
<b>C. Overload/Over-Voltage/No-Contact Operations</b>	
<b>Messages</b>	
Instrument Errors . . . . .	Messages-2
GPIB Errors . . . . .	Messages-3
<b>Index</b>	

# Figures

---

1-1. Power Cable Supplied . . . . .	1-11
1-2. Voltage Selector and Fuse . . . . .	1-12
1-3. Connecting 16338A . . . . .	1-19
3-1. Front Panel . . . . .	3-2
3-2. Test Level and Measurement Range Setup . . . . .	3-4
3-3. Source Delay and Trigger Delay . . . . .	3-7
3-4. Rear Panel . . . . .	3-14
3-5. Required External Trigger Pulse Specification . . . . .	3-14
3-6. Pin Assignment For Handler Interface Connector . . . . .	3-16
3-7. Timing Diagram . . . . .	3-18
3-8. Definition of Impedance . . . . .	3-20
3-9. Vector Representation of Impedance . . . . .	3-20
3-10. Relationship between Measurement Parameters . . . . .	3-21
3-11. Simplified Model of 4338B . . . . .	3-22
4-1. Simple Program Example . . . . .	4-4
4-2. SRQ generation sequence (when measurement finishes) . . . . .	4-11
4-3. Detecting the completion of measurement using SRQ . . . . .	4-12
4-4. Reading out the measured result in ASCII transfer format by using the *TRG command . . . . .	4-15
4-5. Reading out the measured result in binary transfer format using *TRG command . . . . .	4-17
4-6. Reading out the measured result in ASCII transfer format using the :FETC? command . . . . .	4-19
4-7. Reading out measured result in binary transfer format using :FETC? command . . . . .	4-21
5-1. Proper Use of the Colon and Semicolon . . . . .	5-4
5-2. Status Reporting Structure . . . . .	5-34
5-3. Status byte Register . . . . .	5-35
5-4. Standard Event Status Register . . . . .	5-36
5-5. Standard Operation Status Group Structure . . . . .	5-37
5-6. Trigger System Configuration . . . . .	5-39
5-7. Inside an Event Detection State . . . . .	5-40
5-8. NR1 Format . . . . .	5-41
5-9. NR2 Format . . . . .	5-41
5-10. NR3 Format . . . . .	5-41
5-11. Real Data Format . . . . .	5-42
6-1. Measuring Contact Resistance . . . . .	6-4
6-2. Measuring Internal Resistance of Batteries . . . . .	6-5
6-3. Application Sample Program . . . . .	6-7
7-1. SHORT Correction . . . . .	7-1
7-2. Test Lead Extension . . . . .	7-3
9-1. Test Signal Frequency Accuracy Test Setup . . . . .	9-4
9-2. Resistance Measurement Accuracy Test Setup . . . . .	9-7
9-3. Test Signal Level Functional Test Setup . . . . .	9-12
9-4. Handler Interface Functional Test Setup . . . . .	9-14
9-5. Handler interface Output Order . . . . .	9-15
A-1. Serial Number Plate . . . . .	A-3
B-1. Handler Interface Comparison Output Signals Diagram . . . . .	B-2

B-2. Handler Interface Control Output Signals Diagram . . . . . B-3  
B-3. Handler Interface Input Signal Diagram . . . . . B-4  
B-4. A1 Main Board Location . . . . . B-7

# Tables

---

1-1. Line Voltage Selection . . . . .	1-12
3-1. Line Voltage selection . . . . .	3-15
3-2. Contact Assignment for Comparator Function . . . . .	3-17
3-3. GPIB Interface Capability . . . . .	3-19
3-4. Source Voltage and Source Resistance . . . . .	3-22
5-1. Suffix Multiplier . . . . .	5-6
5-2. Measurement Parameter Selection . . . . .	5-11
5-3. Status Byte Assignments . . . . .	5-35
5-4. Standard Event Status Register Assignments . . . . .	5-36
5-5. Operation Status Condition Register Assignments . . . . .	5-38
5-6. Operation Status Event Register Assignments . . . . .	5-38
5-7. Questionable Status Register Assignments . . . . .	5-38
8-1. Measurement Accuracy . . . . .	8-4
9-1. Required Equipment . . . . .	9-1
9-2. Resistance Measurement Accuracy Test Settings . . . . .	9-8
9-3. . . . .	9-13
A-1. Manual Changes by Serial Number . . . . .	A-1
A-2. Manual Changes by ROM Version . . . . .	A-1
B-1. Handler Output Electrical Characteristics . . . . .	B-1
B-2. Handler Input Electrical Characteristics . . . . .	B-4
B-3. Pull-up Resistor Locations . . . . .	B-8
C-1. OVLD/OVVOL/N.C. Condition . . . . .	C-1
C-2. Combination of any two OVLD/OVVOL/N.C. Conditions . . . . .	C-2
C-3. Simultaneous OVLD/OVVOL/N.C. Condition . . . . .	C-3





# Getting Started

---

## Introduction

This chapter provides the information necessary to get you started using your 4338B Milliohmmeter. This chapter discusses the following topics:

- Overview
- Incoming Inspection
- Ventilation Requirements
- Instruction for Cleaning
- Power Cable
- Preparation for Use
- Using Front-Panel Keys
- Basic Operation

---

## Overview

4338B Milliohmmeter is a precise, reliable, and high speed test tool for measuring low resistance.

## Features

Low and selectable test signal current: 1  $\mu\text{A}$  to 10 mA  
Wide measurement range: 10  $\mu\Omega$  to 100 k $\Omega$   
10  $\mu\Omega$  resolution  
1 kHz ac measurement  
High speed measurement: 34 ms  
Built-in comparator  
Auto measurement mode

### ■ Precise Low Resistance Measurement

Contact failure of electro-mechanical components in low current circuits is a key issue in determining these components' reliability. The 4338B offers selectable low level ac test signals (1  $\mu\text{A}$  to 10 mA), so now low current conditions can be characterized. A high resolution of 10  $\mu\Omega$  allows you to determine the slightest differences in contact resistance testing of relays, switches, connectors, PC board traces, and cables. The 1 kHz test signal eliminates potential errors introduced by thermo-electric effects across the DUT contacts. The 1 kHz ac test signal is the best solution for evaluating the internal resistance of batteries because it avoids dc energy consumption.

### ■ High Speed Measurements

The high speed (34 ms), built-in comparator, and GPIB/handler interfaces makes it possible to construct a measurement system using an automatic handler and an external computer to minimize production test time.

### ■ Auto Measurement Mode

When performing gross continuity testing where the test signal level is not a significant factor in the test, the auto measurement function allows the 4338B to select the appropriate test signal level and measurement range.

**Accessories Available**

<b>16338A</b>	Test Lead Set <ul style="list-style-type: none"><li>16005B Kelvin Clip Lead (0.4 m, with large clip)</li><li>16005C Kelvin IC Clip Lead (0.4 m, IC clip)</li><li>16006A Pin-Type Probe Lead (0.4 m)</li><li>16007A Alligator Clip Leads (0.4 m, with 2 red clips)</li><li>16007B Alligator Clip Leads (0.4 m, with 2 black clips)</li><li>16143B Mating Cable (0.6 m)</li></ul>
<b>16064B</b>	LED Display/Trigger Box (pass/fail display and trigger)

### Front Panel

This section gives a guided tour of the 4338B's front panel.

- For a detailed description of each key's function, see Chapter 3.
- Each description starting with (Shift) is the secondary function of the key, which is available by pressing the BLUE shift key (see 32).

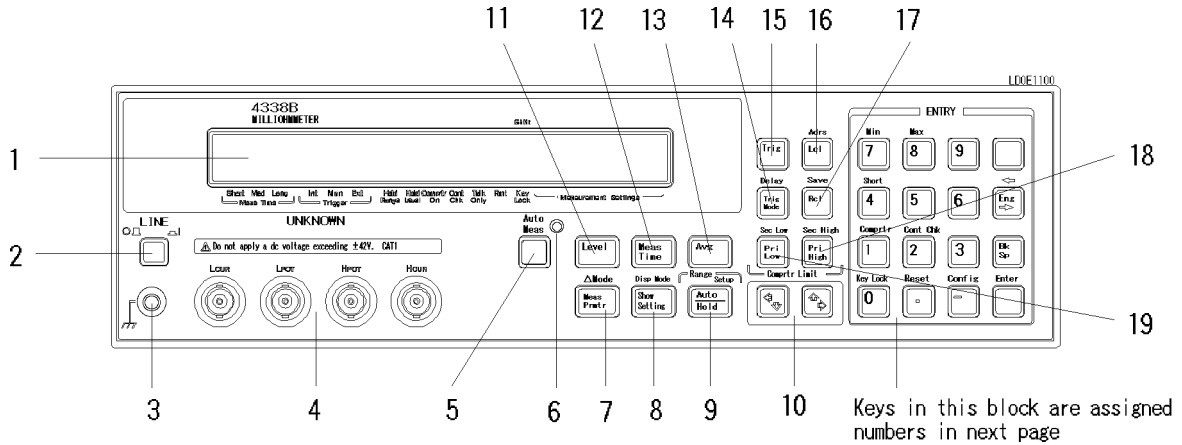

1. **Display** displays the measurement result, instrument states and messages. For more information, see “Display”.
2. **LINE Switch** turns the 4338B ON and OFF.
3. **Chassis Terminal** is connected to the instrument’s chassis.
4. **UNKNOWN Terminals** are the test ports for test fixtures and test leads. Connector type is BNC.
5. **Auto Measurement Key** enables or disables the Auto measurement function.
6. **Auto Measurement Indicator** turns ON when Auto Measurement is enabled, and OFF when disabled.
7. **Measurement Parameter Key** sets measurement parameter to be displayed.  
(Shift) **Deviation Mode Key** enables the deviation measurement function.
8. **Show Setting Key** changes the mode of Measurement Settings display.  
(Shift) **Display Mode Key** selects the display mode.
9. **Auto/Hold Range Key** selects the Auto or Hold range mode.  
(Shift) **Range Setup Key** toggles the measurement range mode between Auto and Hold.
10. **Left/Down Arrow Key and Right/Up Arrow Key** increases or decreases setting value.
12. **Measurement Time Key** selects the measurement time, from Short, Medium, or Long.
13. **Averaging Key** sets the averaging rate used to average the measurement result.
13. **Level Key** selects the source output level.

14. **Trigger Mode Key** selects the trigger mode.  
(Shift) **Delay Key** selects the trigger source from Internal, Manual, or External.
15. **Trigger Key** triggers a measurement when in the Manual trigger mode.
16. **Local Key** returns the 4338B to the local mode from the GPIB remote mode.  
(Shift) **Address Key** sets the 4338B's GPIB address.
17. **Recall Key** recalls the instrument state data from 4338B's internal memory.  
(Shift) **Save Key** saves the instrument state data to the 4338B's internal memory.
18. **Primary Comparator Upper Limit (Pri High) Key** - sets the upper limit of the comparator function for the primary comparator.  
(Shift) **Secondary Comparator Upper Limit (Sec High) Key** - sets the upper limit of the comparator function for the secondary comparator.
19. **Primary Comparator Lower Limit (Pri Low) Key** - sets the lower limit of the comparator function for the primary comparator.  
  
(Shift) **Secondary Comparator Lower Limit (Sec Low) Key** - sets the lower limit of the comparator function for the secondary comparator.
20. **0 Key** / (Shift) **Key Lock Key** locks out all key  input except for this key.
21. **. Key** / (Shift) **Reset Key** resets the 4338B to its default state.
22. **- Key** / (Shift) **Configuration Key** sets the beep setting and power line frequency setting, and executes the internal test.
23. **3 Key**
24. **2 Key** / (Shift) **Contact Check Key** toggles the contact check function between ON and OFF.
25. **1 Key** / (Shift) **Comparator Key** toggles the comparator function between ON and OFF.
26. **4 Key** / (Shift) **Short Key** a SHORT correction measurement to get correction data.
27. **5 Key**
28. **7 Key** / (Shift) **Minimum Key** enters the minimum value when setting a parameter.
29. **8 Key** / (Shift) **Maximum Key** enters maximum value when setting a parameter.
30. **6 Key**
31. **9 Key**
32. **BLUE Shift Key** activates secondary functions printed above the front-panel keys.

**Note**

In this manual, the BLUE shift key is expressed as , the top of the key is not labeled with "blue".

33. **Engineering Unit Key** enters the engineering units, p, n,  $\mu$ , m, k, and M.
34. **Back Space Key** erases the last entered character when entering numeric values.
35. **Enter Key** terminates key entry.

## Display

This section introduces the display. For a detailed description of each display field, see Chapter 3.

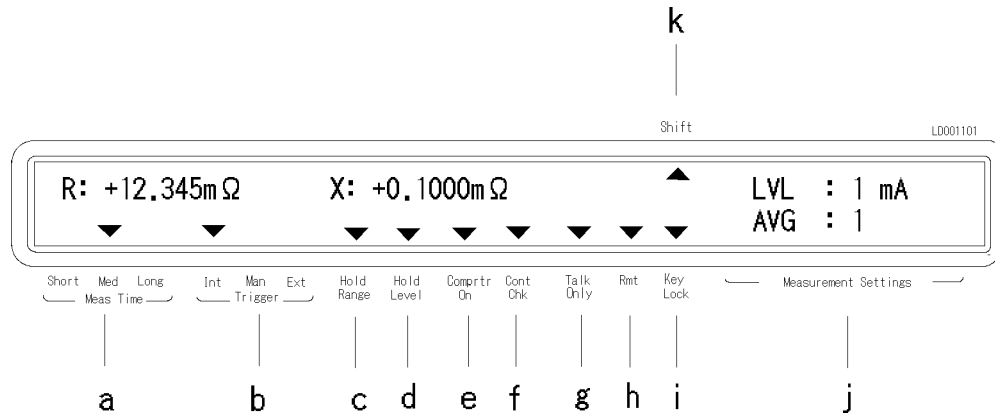

1. **Character Display Area** displays the measurement result, setting data, and instrument messages.
2. **Annunciator (▼)** points to the currently selected instrument setting. The label pointed to by the annunciator is the current setting. The annunciator labels are as follows:
  - a. **Measurement time** shows the selected measurement time, Short, Medium or Long.
  - b. **Trigger** indicates that the trigger mode is Internal, Manual, or External.
  - c. **Hold Range** indicates that the 4338B is in the Hold range mode. When in the Auto range mode, the Hold range annunciator is not displayed.
  - d. **Hold level** indicates that the 4338B is in the Hold level mode. When in the Auto level mode, the Hold level annunciator is not displayed.
  - e. **Comparator On** indicates that comparator function is ON.
  - f. **Contact Check On** indicates that the contact check function is ON.
  - g. **Talk Only** indicates that the 4338B is in the GPIB talk only mode.
  - h. **Remote** indicates that the 4338B is in the GPIB remote mode.
  - i. **Key Lock** indicates that the 4338B's front panel keys are locked out.
  - j. **Measurement Setting** Shows the 4338B's settings such as test signal level, averaging rate, etc.
  - k. **Shift** annunciates that the shift toggle is active.



## Rear Panel

This section gives a guided tour of the rear panel. For a detailed description of each item, see Chapter 3.

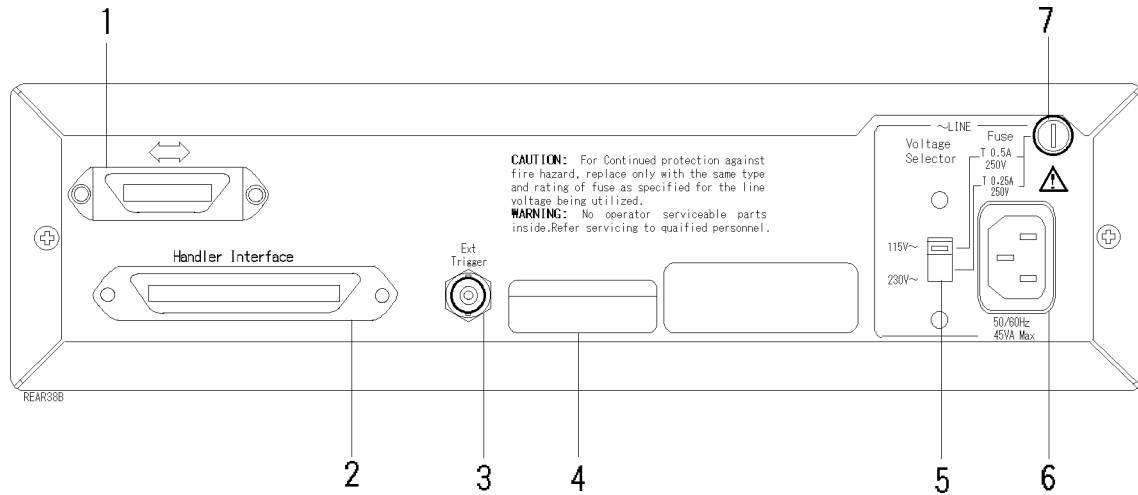

1. **GPIB Interface** is used to control the 4338B from an external controller by using the GPIB bus.
2. **HANDLER Interface** is used to synchronize timing with an external handler.
3. **EXT TRIGGER Terminal** is used to input an external trigger signal.
4. **Serial Number Plate** gives the instrument's manufacturing information.
5. **Line Voltage Selector** used to set the 4338B's line voltage setting to the voltage of the ac power source.
6. **Power Cord Receptacle**
7. **LINE Fuse Holder**

---

## Incoming Inspection

---

### Warning



**To avoid hazardous electrical shock, do not turn on the 4338B when there are signs of shipping damage to any portion of the outer enclosure (for example, covers, panel, or display)**

---

Inspect the shipping container for damage. If the shipping container or cushioning material is damaged, it should be kept until the contents of the shipment have been checked for completeness and the 4338B has been checked mechanically and electrically. The contents of the shipment are as follows:

- 4338B LCR Meter
- Power Cable
- Operation Manual(This Book)
- User's Guide

If the contents are incomplete, if there is mechanical damage or defect, or if the analyzer does not pass the power-on selftests, notify the nearest Agilent Technologies office. If the shipping container is damaged, or the cushioning material shows signs of unusual stress, notify the carrier as well as the Agilent Technologies office. Keep the shipping materials for the carrier's inspection.

---

## Providing clearance to dissipate heat at installation site

To ensure the specifications and measurement accuracy of the product, you must keep ambient temperature around the product within the specified range by providing appropriate cooling clearance around the product or, for the rackmount type, by forcefully air-cooling inside the rack housing. For information on ambient temperature to satisfy the specifications and measurement accuracy of the product, refer to Chapter 8, Specifications.

When the ambient temperature around the product is kept within the temperature range of the operating environment specification (refer to "General" in Chapter 8), the product conforms to the requirements of the safety standard. Furthermore, under that temperature environment, it has been confirmed that the product still conforms to the requirements of the safety standard when it is enclosed with cooling clearance as follows:

	Conditions
Rear	400 mm
Side	100 mm
Upper	15 mm

---

## Instruction for Cleaning

For cleaning, wipe with soft cloth that is soaked with water and wrung tightly without undue pressure.

## Power Cable

In accordance with international safety standards, this instrument is equipped with a three-wire power cable. When connected to an appropriate ac power outlet, this cable grounds the instrument frame. The type of power cable shipped with each instrument depends on the country of destination. Refer to Figure 1-1 for the part numbers of the power cables available.

---

**Warning**

**For protection from electrical shock, the power cable ground must not be defeated. The power plug must be plugged into an outlet that provides a protective earth ground connection.**

---

<p><b>OPTION 900</b></p>  <p>Plug : BS 1363A, 250V Cable : 8120-1351</p>	<p><b>OPTION 901</b></p>  <p>Plug : NZSS 198/AS C112, 250V Cable : 8120-1369</p>
<p><b>OPTION 902</b></p>  <p>Plug : CEE-VII, 250V Cable : 8120-1689</p>	<p><b>OPTION 903</b></p>  <p>Plug : NEMA 5-15P, 125V, 15A Cable : 8120-1378</p>
<p><b>OPTION 904</b></p>  <p>Plug : NEMA 6-15P, 250V, 15A Cable : 8120-0698</p>	<p><b>OPTION 906</b></p>  <p>Plug : SEV 1011.1959-24507 Type 12, 250V Cable : 8120-2104</p>
<p><b>OPTION 912</b></p>  <p>Plug : DHCR 107, 220V Cable : 8120-2956</p>	<p><b>OPTION 917</b></p>  <p>Plug : SABS 164, 250V Cable : 8120-4211</p>
<p><b>OPTION 918</b></p>  <p>Plug : JIS C 8303, 125V, 15A Cable : 8120-4753</p>	<p><b>OPTION 922</b></p>  <p>Plug : GB 1002, 250V Cable : 8120-8376</p>
<p>NOTE: Each option number includes a 'family' of cords and connectors of various materials and plug body configurations (straight, 90° etc.).</p>	

Figure 1-1. Power Cable Supplied

## Preparation for Use

Before you use the 4338B, you must set the 4338B to match the available power line voltage and frequency.

- set line voltage — see “Power Requirements”.
- set line frequency — see “Turning ON the 4338B”.

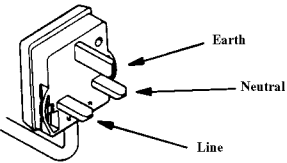
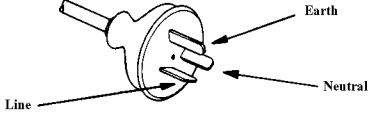
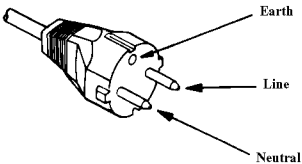
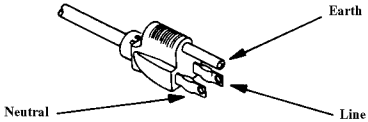
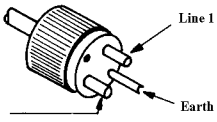
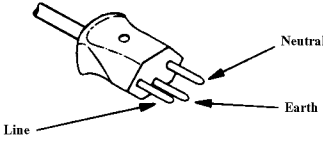
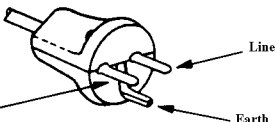
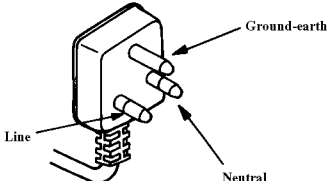
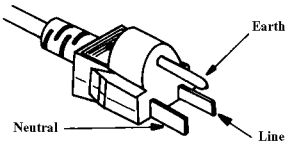
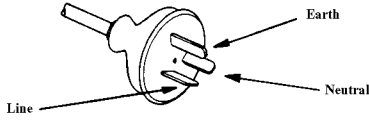
### Power Requirements

The 4338B’s power source requirements are as follows:

**Power Line Voltage :** 100/120/220/240 Vac( $\pm 10\%$ )

**PowerLine Frequency :** 47 to 66Hz

**Power Consumption :** 45 VA maximum

Confirm that the LINE Voltage Selector on rear panel is set to match the power line voltage before plugging in the 4338B. Refer to Figure 1-2

1. Confirm that the power cable is disconnected.
2. Slide the LINE Voltage Selector on the rear panel to match your power line voltage. When your power line voltage is 100/120 Vac( $\pm 10\%$ ), slide the Selector to 115 V. When your power line voltage is 220/240 Vac( $\pm 10\%$ ), slide the Selector to 230 V. See Figure 1-2.

### Fuse

Use the fuse shown in Table 1-1. If you require the fuse, contact the nearest Agilent Technologies sales office.

The fuse can be replaced by turning the fuse holder shown in Figure 1-2 counterclockwise until the fuse holder pops out with a minus screw driver.

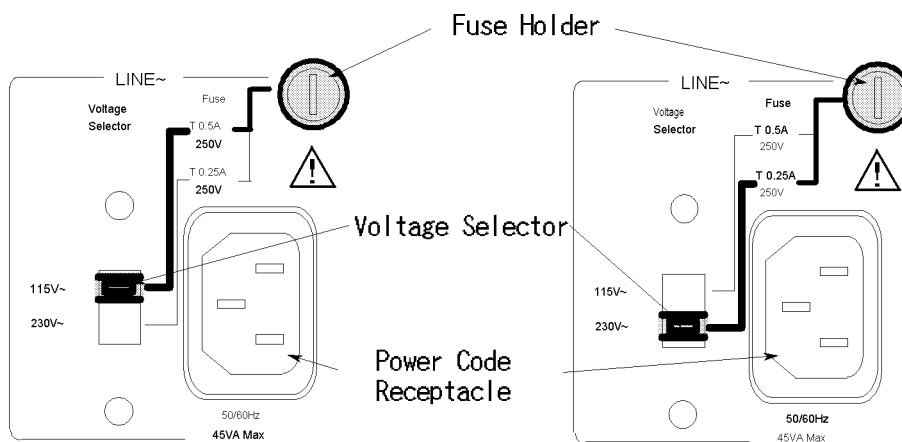

**Figure 1-2. Voltage Selector and Fuse**

**Table 1-1. Line Voltage Selection**

Voltage Selector	Power Line Voltage	Required Fuse
115V	100/120Vac( $\pm 10\%$ )	UL/CSA type, Time delay 0.5A 250V (Agilent part number 2110-0202)
230V	220/240Vac( $\pm 10\%$ )	UL/CSA type, Time delay 0.25A 250V (Agilent part number 2110-0201)

## Turning ON the 4338B

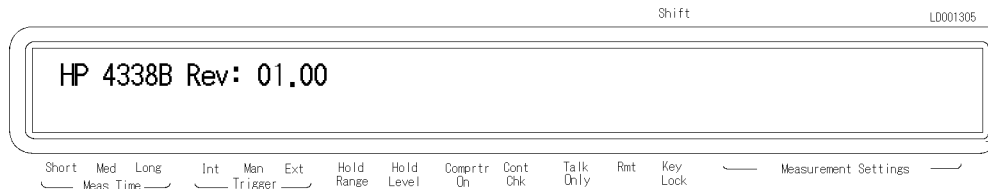

1. Connect the power cable to the power cord receptacle on the rear panel.
2. Push the LINE switch in. The 4338B will emit a beep when it turns ON and perform the self test. (If any message is displayed, see “Error Messages” in the back of this manual.) The 4338B will be ready for operation after a message like the one shown in the following figure is displayed.



3. Confirm that the power line frequency setting is correct.

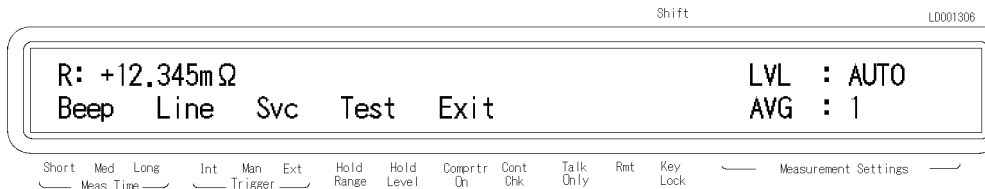

- a. Press  . The following menu is displayed.

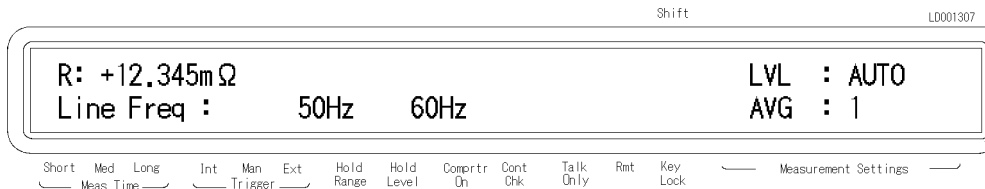

- b. Press  until the Line blinks, then Press .



A blinking item is selected.

- c. If the setting does not match the ac line frequency, press  to toggle the setting between 50 Hz and 60 Hz.
- d. Press  two times to exit this menu.

The power line frequency setting is stored and does not change after reset or on power-off. Once you set it, you do not need to set the line frequency again as long as the same power line frequency is being used.

## Using Front-Panel Keys

The 4338B has four types of keys as follows:

- Direct Execution Keys
- Toggle Keys
- Selection Keys
- Value Setup Keys

This section describes how to use the 4338B's front panel keys.



### Note



If you want to exit an operation and go back to the measurement display, press  several times.



## Direct Execution Keys

Pressing a direct execution key will cause the pressed key's function to be performed immediately. For example,



Press  , and the 4338B's front panel keys are locked out.

## Toggle Keys

Pressing a toggle key will switch between several conditions. An annunciator will indicate the current condition. For example,

Press , and the **Meas Time** annunciator() alternately points to the current setting (Short, Med or Long).



## Selection Keys

Pressing a selection key will display the selection display. The blinking item is the one currently selected. By using , , or the selection key itself, the selected (blinking) items can be changed.

For example, to perform the self test,

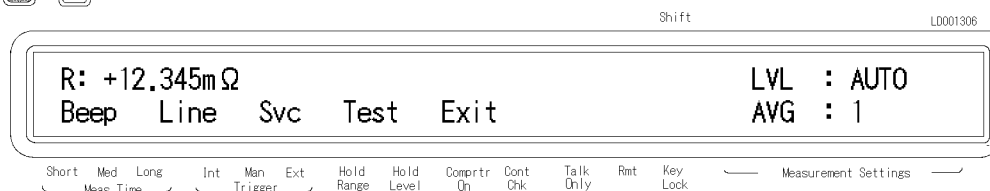
1. Press  . **Exit** is blinking.



2. Press  to blink **Test**.
3. Press . The self test will start immediately. After the test is finished, the 4338B will display any existing error code, and return to the menu.
4. Select **Exit** and press  to exit the menu.

### Value Setup Keys

Pressing the value setup keys displays the parameter entry display and prompts for you to enter a value. For example,

1. Press  and the 4338B displays,

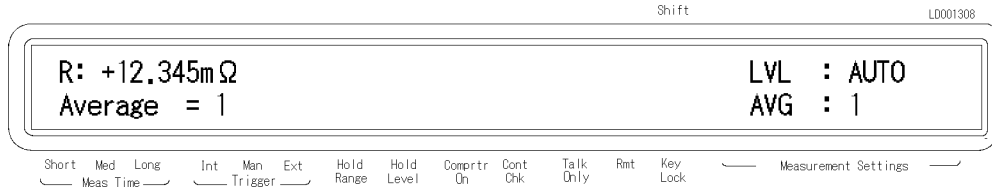

The displayed value can be altered by using the following keys:

- Numeric Keys
- Maximum and Minimum Keys
- Left/Down and Right/Up Arrow Keys
- Back Space Key

### Numeric Keys

Some commands use numeric parameters. A numeric parameter is the actual value used by the 4338B. For example, to set the averaging rate to 10,

1. Press   .

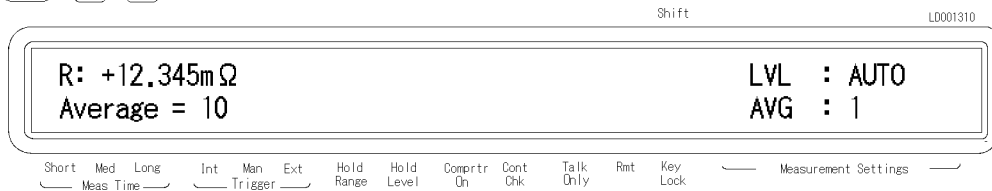

2. Press .



You can also enter numeric parameters using engineering units.

1. Press . The comparator limit menu is displayed.

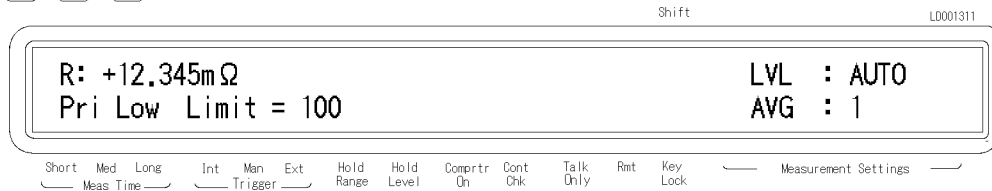

2. Press   .

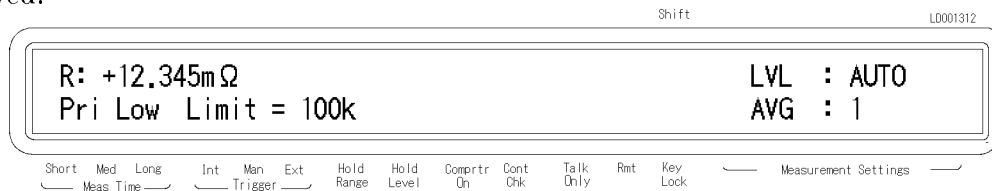

3. Press  and the engineering unit will be displayed with 100. For example 100K will be displayed.





4. Press  more several times and the engineering units are displayed alternately in increasing order.

5. Press  , and the engineering unit previously displayed will be displayed again.

6. Press  to enter the value and exit this menu.



**Note**





Before you press , the previous setting is still the current setting, even though the displayed value has changed. If you press a key other than one of the keys in ENTRY block before pressing , the setting will not change and the displayed value will be discarded.

**Maximum and Minimum Keys**

These keys enter the maximum and minimum numeric value in place of using the numeric keys. For example,

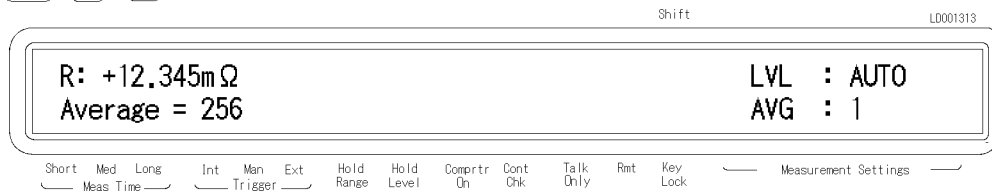



1. Press    and you will get the maximum value of averaging rate (256).



2. Press  to enter the value and exit this menu.





### Left/Down and Right/Up Arrow Keys

Increments or decrements numeric entry. For example,

1. Press   to bring up the GPIB address setup display.
2. Press  several times and confirm a change in value.
3. Press  to exit the setup display.

### Back Space Key

Erases the last entered character, and cancels the input value. For example,

1. Press  to select comparator limit menu.
2. Press    .

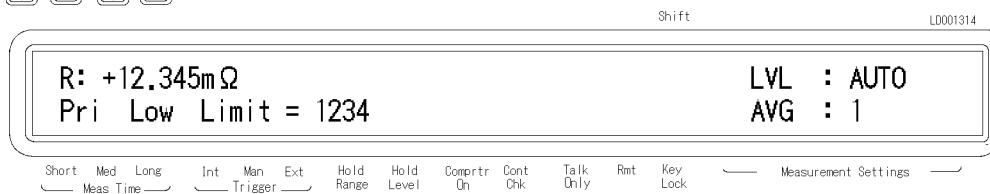

3. Press .

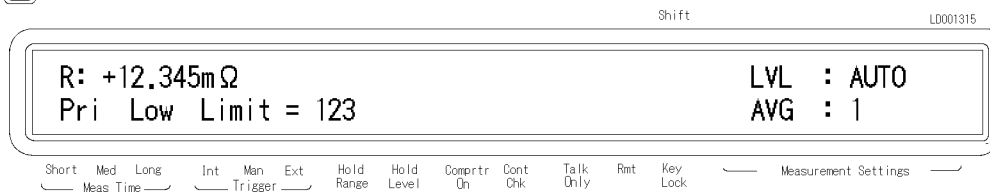

Last entered 4 is erased.

---

## To Perform a Measurement

The following procedure is commonly used to perform a measurement using the 4338B:

1. Configuration setup
2. Turning on the 4338B
3. Connecting DUT to test fixture
4. Correction
5. Setting parameters
6. Measurement

This section provides the basic measurement procedure for using the 4338B. Follow the instructions and get to know about the 4338B.

- To Connect Test Fixture
- To Reset 4338B
- To Perform Short Correction
- To Select Measurement Parameter
- To Select Auto Measurement Mode
- To Select Measurement Range
- To Set Test Voltage

---

**Caution**  DO NOT apply a dc voltage exceeding  $\pm 42$  V to UNKNOWN terminals, or input circuit of the 4338B will be destroyed.



---

**Note** If you have any problems operating the 4338B, see “If You Have a Problem” in Chapter 2.



## Connecting a Test Fixture

The following describes the available test fixtures for the 4338B and their connection to the 4338B.

### Note



The 16338A Test Lead set is available for the 4338B. Other fixtures must NOT be used with the 4338B, even if the UNKNOWN terminals physically match a test fixture's connector spacing because the terminals' configuration is different.

### Using the 16338A

The 16338A test lead set contains four types of test leads, which are used depending on the DUT type.

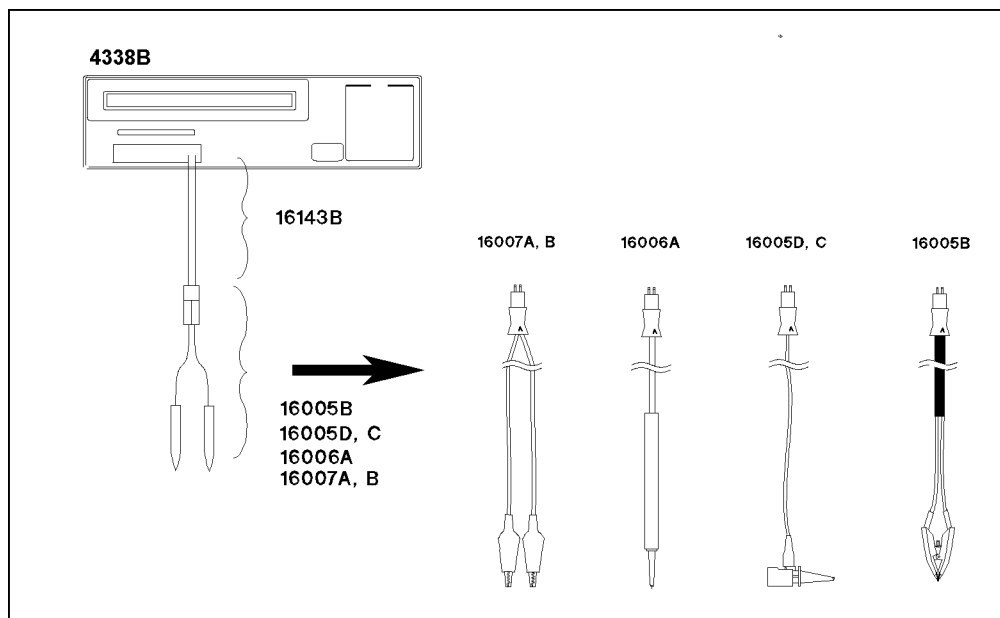

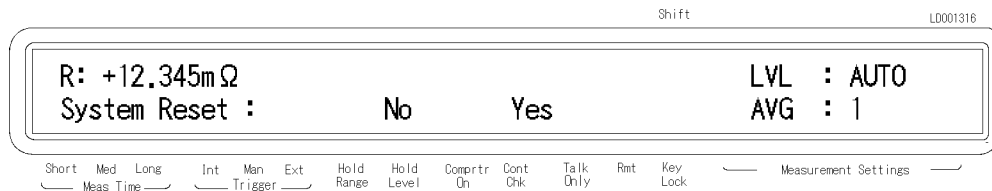



Figure 1-3. Connecting 16338A



## To Reset 4338B

Resetting the 4338B sets its settings to their default states.

1. Press   to select the reset menu.



2. Press  to select Yes(Yes blinks), then press .

The 4338B is now set to the default state. For more information about the default state, refer to “Reset Key  ” in Chapter 3.

## To Perform a SHORT Correction



Correction is used to cancel the residual errors of the cables and the test fixture. The SHORT correction cancels residual impedance in series with the DUT.

1. Connect the electrodes of fixture to obtain a SHORT condition.



**Note**

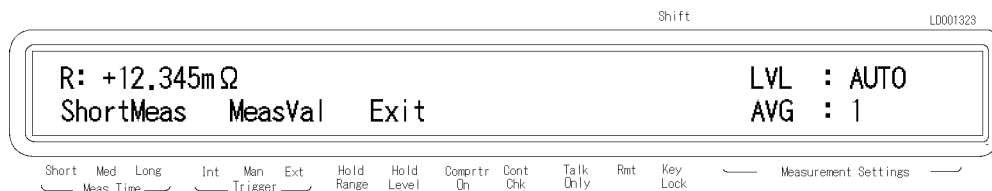

The SHORT condition is obtained by using a shorting bar, or by connecting the test leads together. For details on making a good SHORT, see the manual supplied with the test fixture being used.

2. Press  . The SHORT correction menu is displayed.



3. Press  or  until ShortMeas blinks, and press . The SHORT correction is in progress, and the following message is displayed.

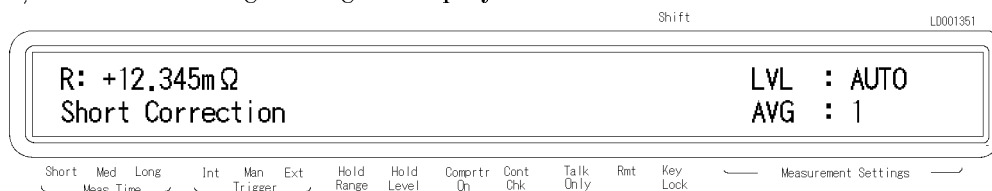

After a short time, the 4338B will display the message "Short Correction Complete", and return to the normal display.

If the SHORT impedance  $|Z_s|$  is NOT less than 10  $\Omega$ , which is unsuitable for use as the SHORT correction data, the 4338B will display the following warning message.

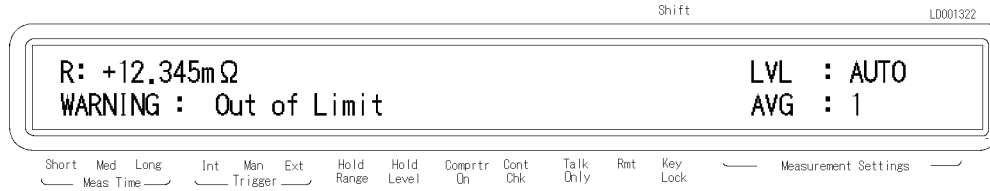

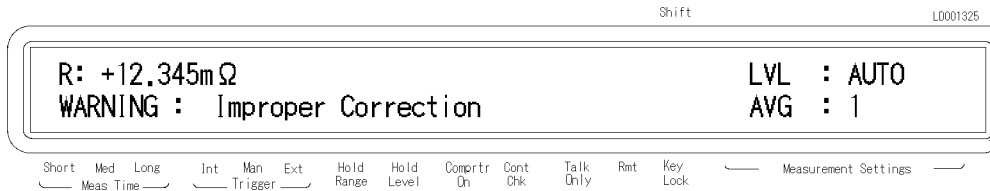

This is only a WARNING, the SHORT correction data will still be used. However, it is better to confirm that the test fixture's connection to UNKNOWN terminals is good and confirm that the procedure used to perform the SHORT correction.

When the "OVLD", "OVVOL" or "N.C." is displayed during the SHORT correction, the 4338B will display the following warning message. When the contact check function is ON, the values of "9.9999E13" are stored as R and X in the MeasVal.



If you select MeasVal in the short correction menu, the 4338B displays the SHORT correction data.

1. Select MeasVal and press . The 4338B displays the primary parameter R of the SHORT correction data.
2. Press . The 4338B displays the secondary parameter X.
3. Press  to return to the SHORT correction menu.

### Note



When "WARNING : Improper Correction" is displayed, 99.999TΩ are set at R, X values.

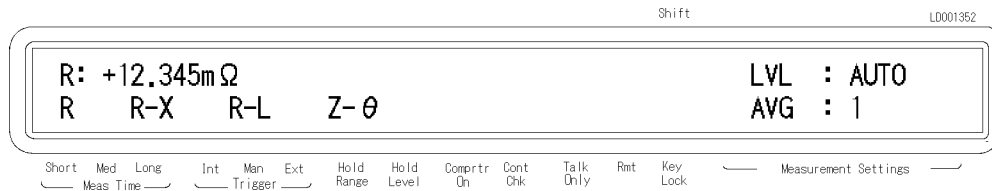

## To Select Measurement Parameter

1. Press . The following menu is displayed.



2. Press  or  to select the desired parameter, then press .

- R
- R-X
- R-L
- Z-θ

## To Select Auto Measurement Mode

The 4338B has an Auto Measurement Function which allows automatic selection of the optimum measurement range and test signal level. To activate the auto measurement mode:

Press .

The auto measurement indicator turns ON. If the **Hold Range** annunciator(▼) or **Hold Level** annunciator(▼) is displayed, the indicator turns off.





## To Select Test Signal Level

The 4338B has five test current levels – 1  $\mu$ A, 10  $\mu$ A, 100  $\mu$ A, 1 mA, and 10 mA. In addition to these selection, you can select also the auto level mode, in which the 4338B automatically selects the optimum measurement test level. If the test level is set other than the auto level mode, the **Hold Level** annunciator(▼) is displayed.

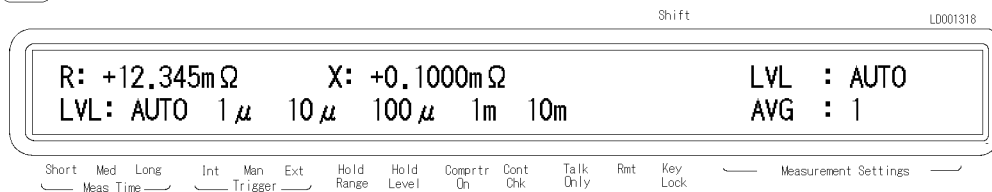
To select the test level:

1. press . Auto and available test signal levels are displayed.



2. Press  or  until the desired level blinks. If you want to select the auto level mode, press  or  until Auto blinks.

3. Press .

## To Select Measurement Range

### Auto / Hold Range Mode

The 4338B has two measurement range modes, Auto and Hold. The Auto mode changes the measurement range automatically to fit the measured value. The Hold mode fixes the measurement range.

To select the range mode,



Press  and the **Hold Range** annunciator(▼) is alternately displayed and turned off.

In Hold range mode, the **Hold Range** annunciator is displayed. The Auto range mode is active when the **Hold Range** annunciator is not displayed.

### Measurement Range Setting

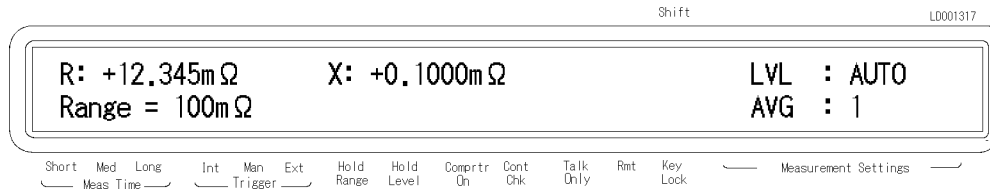
1. Press . Measurement range menu is displayed.



2. Press  or  until the desired range is displayed.

3. Press .

### Note



You may find some measurement range cannot be set because the 4338B has test signal level limitations for each measurement range setting. For details, see Figure 3-2.





# Operating the 4338B

---

## Introduction

This chapter provides step-by-step instructions for using the 4338B Milliohmmeter. This chapter includes the following sections:

- Measurement Configuration
- Making a measurement
- Testing the 4338B
- If You Have a Problem

Refer to Chapter 3 for the description of each front panel key function.

## Measurement Configuration

This section discusses the 4338B's general configuration topics that apply to many or all measurement functions.

### To Select the Measurement Time Mode

The current measurement time mode setting (Short, Med or Long) is indicated by the **Meas Time** annunciator(▼). To select the measurement time mode:

1. Press  until the measurement time mode is set to the desired mode.

### To Set the Averaging Rate

To set the averaging rate :

1. Press .

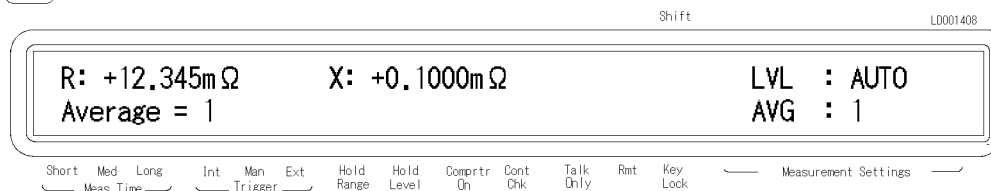

2. Enter the desired value.
3. Press  to set the value and to exit.

The current setting is displayed on the right side of the LCD display. When the current setting is not displayed, press  until it is displayed.



### To Set the Trigger Delay or Source Delay Time

To set the trigger delay or the source delay time:

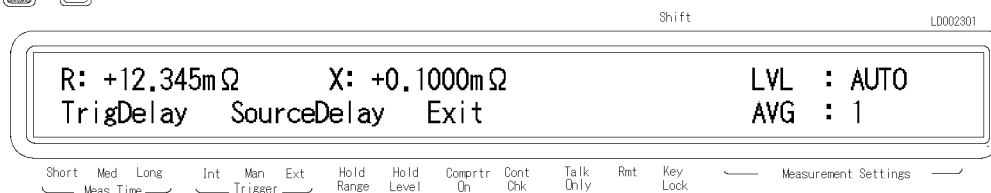
1. Press  .



- To set the trigger delay time:

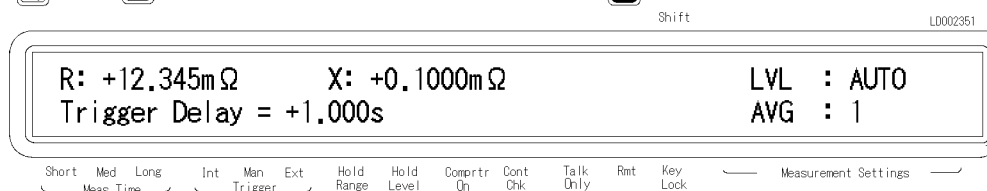

Press  or  until TrigDelay blinks, and press .





Enter the desired value using the numeric keys, and press .

When you want to exit without changing value, just press .

- To set the source delay time:

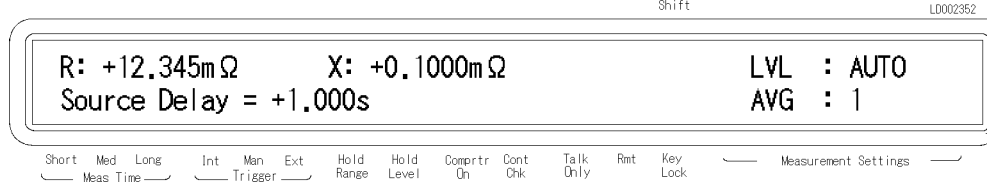
Press  or  until SourceDelay blinks, and press .





Enter the desired value using the numeric keys, and press .  
When you want to exit without changing value, just press .

To display the current setting, press  until the setting value is displayed on the right side of the LCD display.



### To Set the Contact Check

The **Cont Chk** annunciator(▼) indicates the ON/OFF state of the contact check function. The contact check function is turned ON/OFF as follows:

- To turn ON the contact check function:

Press  . The Cont Chk annunciator(▼) is displayed.

- To turn OFF the contact check function:

Press   again. The Cont Chk annunciator(▼) disappears.

## To Set the Beeper Mode





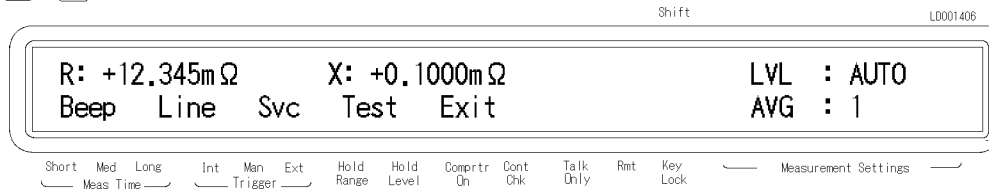

To set the beeper mode for the comparator result reporting:

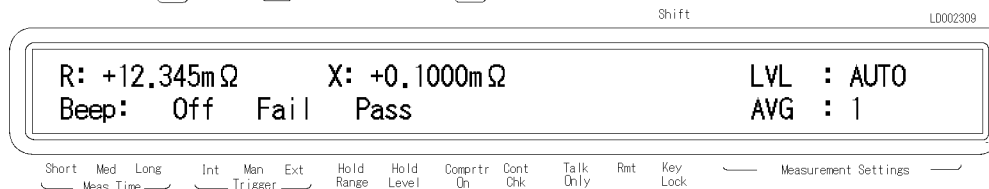
1. Press  .



2. Select Beep using  or , and press .





3. Select the desired mode (Fail, Pass or Off) using  or , and press .
4. Select Exit using  or , and press  to exit.

## To Save and Recall Instrument Settings

The 4338B can save and recall the instrument's settings.

- To save the current settings:

1. Press  .
2. Enter the register number (0 to 9) that you want to save the settings into.

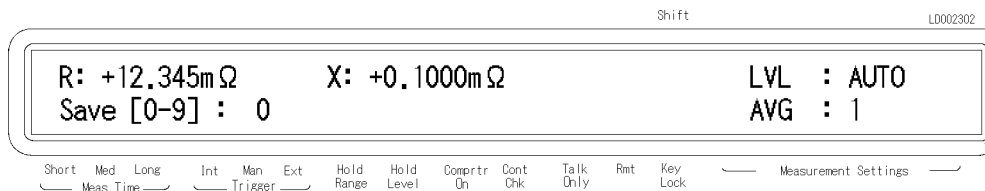

3. Press  to save.

### Note

Record the register number that you saved into for further reference.



- To recall a setting.

1. Press .

2. Enter the register number (0 to 9) that you want to recall the settings from.

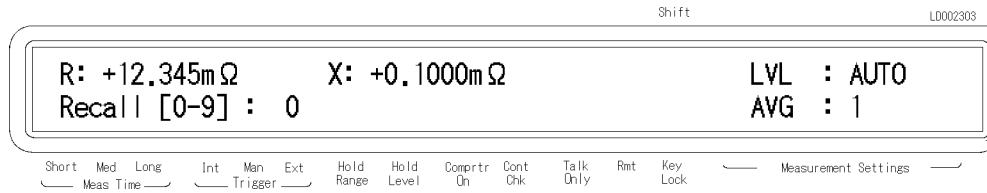

3. Press  to recall.

---

## Making a Measurement

### To Trigger a Measurement

The 4338B has four trigger source modes: Internal, Manual, External, or Bus. The **Trigger** annunciator shows which trigger source is selected.

---

**Note**



The bus trigger mode can be set by GPIB commands only. When the bus trigger mode is selected, none of the Trigger annunciators are ON.

---

#### ■ To Trigger Internally

1. Press  until the **Int** trigger annunciator(▼) is ON.

#### ■ To Trigger Manually

1. Press  until the **Man** trigger annunciator(▼) is ON.
2. Press  when you want to trigger a measurement.





#### ■ To Trigger Externally

1. Connect the external trigger source to the EXT TRIGGER terminal on the 4338B's rear panel.
2. Press  until the **Ext** trigger annunciator(▼) is ON.
3. Apply a trigger signal to trigger the 4338B.

## To Use the Comparator Function

The comparator function can be used to sort DUTs based on their parameter values. The **Comprtr On** annunciator(▼) tells whether the comparator function is set to ON or OFF.

### ■ To set the limit values:

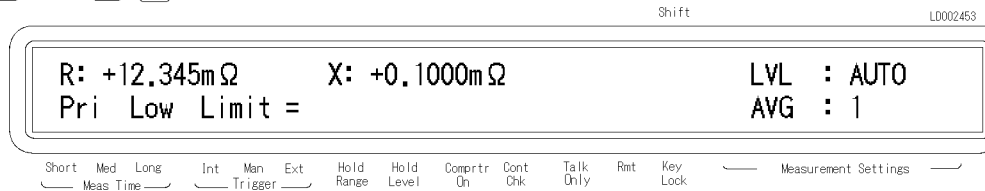

1. Select the parameter to be set by pressing  or  for the primary parameter, and  or  for the secondary parameter.



2. Enter the value using the numeric keys, and press  to enter the value.

### Note



When you want to set the limits only for the lower limit or the upper limit, or the limits only for the primary parameter or the secondary parameter, set the unnecessary parameter to OFF using the  (setting the minimum value) or the  (setting the maximum value).



### ■ To start sorting:

1. Press  .

### ■ To display the sorting results:

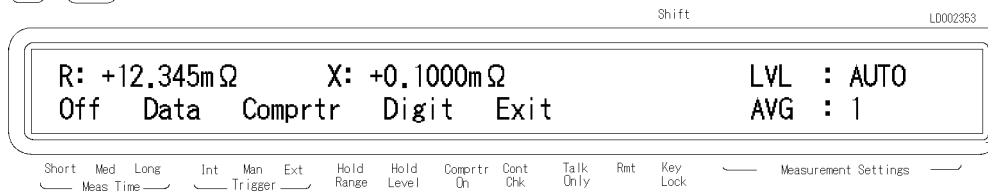
Press . The following menu is displayed.



Select **Comprtr** using  or . The display mode is set to the comparator result display mode, and the comparison result is displayed.



### ■ To stop sorting:



Press  .



**To Display Deviation Data**

The  $\Delta$  before the measurement parameter on the LCD display tells that the displayed value for the parameter is the deviation value.

**To Set the Reference Value**



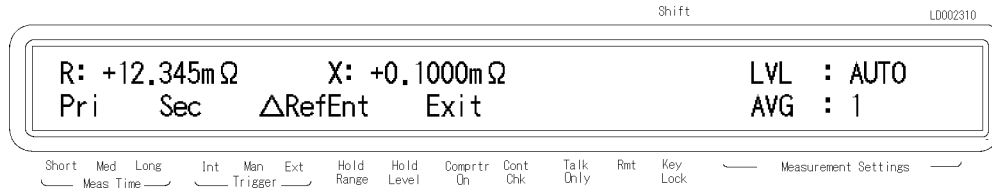

1. Press  . The following menu is displayed.

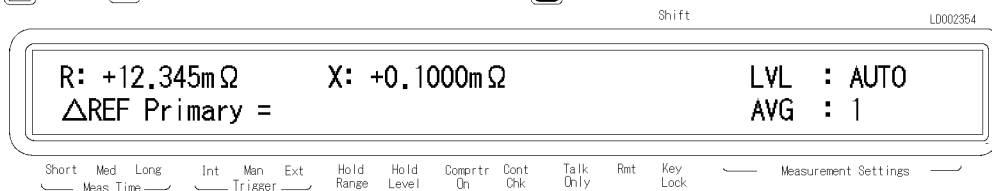





2. Press  or  to select  $\Delta$ RefEnt, and press .



■ To set by measuring the reference DUT:



- a. Press  regardless of the trigger mode, and the primary parameter is measured. Press  to set the measurement value as the primary reference.
- b. Then the secondary parameter reference setting menu ( $\Delta$ Ref Secondary=) is displayed. Press  to measure the secondary parameter, and press  to set the measurement value as the secondary reference.

■ To set by entering a value:



- a. Enter the primary parameter reference value using the numeric keys, and press . When you want to exit without changing value, just press .
- b. Enter the secondary parameter reference value using the numeric keys, and press . When you want to exit without changing value, just press .

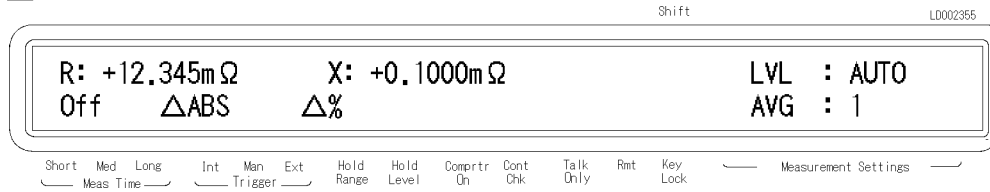

**To Select the Deviation Display Mode**

To select the deviation display mode (Off,  $\Delta$ , or  $\Delta\%$ ),





3. To select the primary parameter deviation display mode, press  or  to select Pri, and press .



Press  or  to select Off,  $\Delta$ ABS, or  $\Delta\%$ , and press .



4. To select the secondary parameter deviation display mode, press  or  to select Sec, and press . The same menu as the primary parameter is displayed, and you can select the mode (Off,  $\Delta$ ABS or  $\Delta\%$ ) in the same manner as the primary parameter.

**To Set the Display Mode and Display Digits**

If you press  , the display mode selection menu appears. Select the desired mode using  or , (Data: displays the measurement data, Comprtr: displays the comparator results, Off: turns the display OFF) and press .

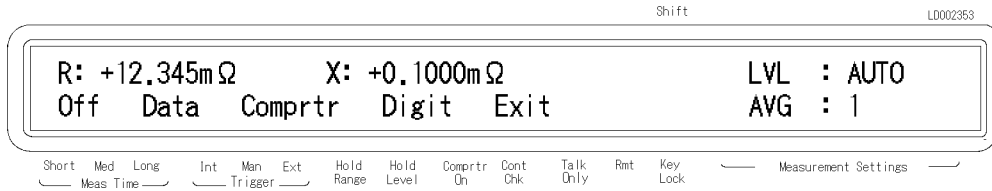
To exit from this menu, select Exit and press .



If you select Digit, the display digits selection menu appears. Select the desired display digits using  or , and press . After selecting the display digits, the 4338B returns to the display mode selection menu.

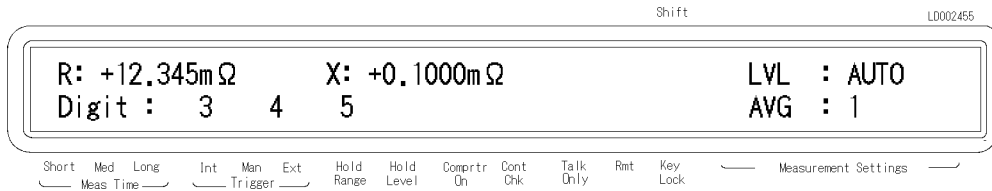

### To Change the Measurement Settings Display Mode

Each time  is pressed, the current settings of the 4338B are displayed one after another on the right side of the LCD display. The information displayed and the order of display is as follows:

1. Test signal level and Averaging rate

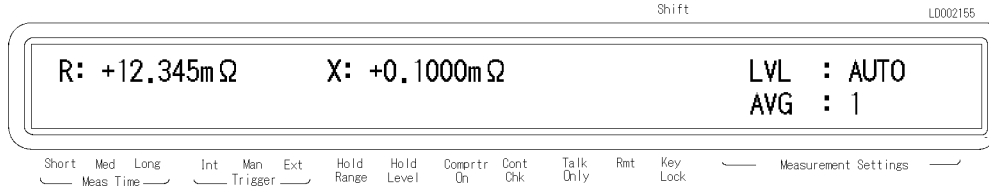

2. Trigger delay time and Source delay time

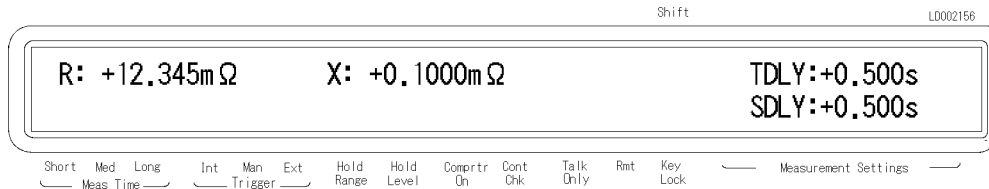

3. Comparator limits of the primary parameter

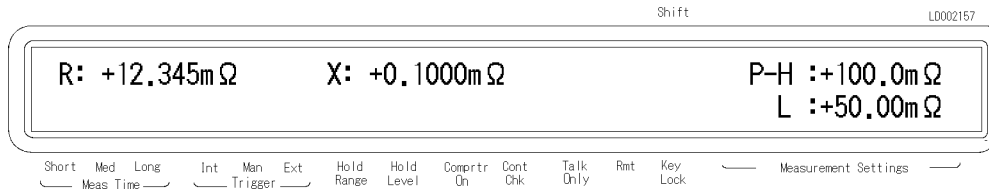

4. Comparator limits of the secondary parameter

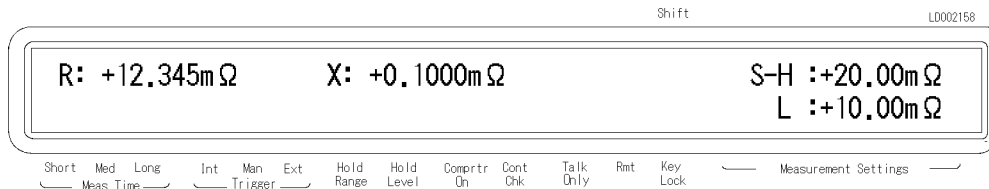

### To Lock Out the Front Panel Keys

To lockout the keys:



Press  .

To unlock the keys:

Press   again.

### To Select the Local Mode

To return the 4338B to the local mode from GPIB remote mode:

Press  .

### To Set the GPIB Address

1. Press  .

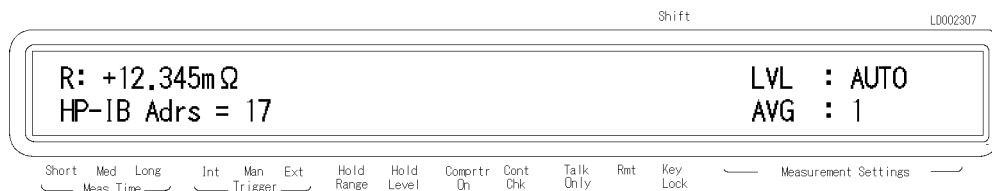

2. Enter the desired value, then press  to set the value and to exit.

When you just want to show the current setting, just press .

### To Print Measurement Data

To print the measurement data to an GPIB compatible printer without using an external controller:

1. Set the printer to listen-always mode.
2. Connect the GPIB compatible printer to the 4338B's GPIB port.
3. Turn the printer ON.
4. Set the 4338B's GPIB address to 31 (talk only mode).

Press     .

The printer will begin printing the measurement data.

5. When you want to stop printing, change the 4338B's GPIB address to an address other than 31 (for example, 17, which is the default setting).

Press     .





## To Test the 4338B

### To Perform a Self-Test

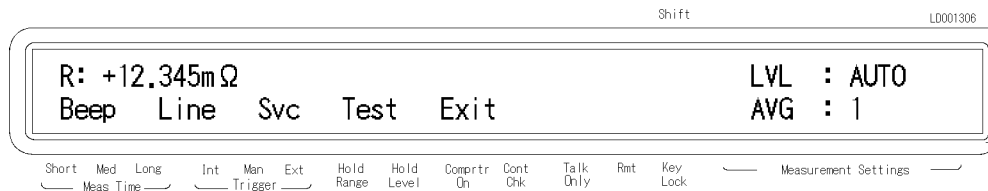
The 4338B has a self-test function to check its basic performance.

1. Press  .



2. Select **Test** using  or , then press  to execute the self test. If any error message is displayed, refer to “Error Messages”.
3. Select **Exit** and press  to exit.





### To Test the Front Panel Keys’ Functionality

The 4338B has a service function to test the functionality of the front panel keys, the handler interface, the ROM, the RAM, and the EEPROM. This section describes how to test the front panel key’s functionality. For the handler interface test, refer to Chapter 9 for the procedure. The other tests are for use by service personnel only.

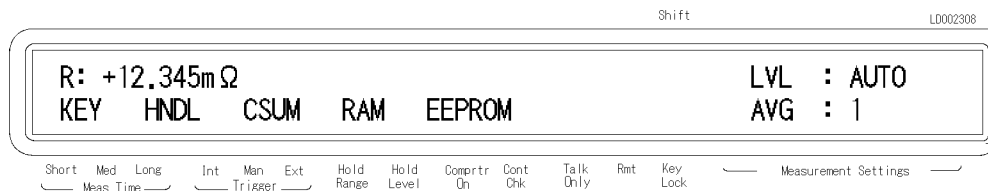

1. Press  .

2. Select **Svc** using  or  and press .



3. Select **KEY** using , or  and press .
4. Press the front panel key that you want to test.  
For example, if you want to test , then press .

When the key functions properly, **KEY CODE:5 TRIGGER** is displayed; otherwise, there will be no such display, the key is not functioning correctly. Contact your nearest Agilent Technologies office.

5. When you want to exit the front panel key test, press  twice.
6. Select **Exit** and press  to exit.

---

## If You Have a Problem

If any of the problems listed below occur, follow the instructions described.

### If the Display is Blank and the 4338B Appears Dead



If the display is blank, and even the annunciators are not ON:

- Check the fuse.

### If an Error Message is Displayed

- Refer to “Messages.”

### If the 4338B does not Accept Any Key Input

- Check whether the **Rmt** annunciator is ON.
  - Check whether the external controller disables all the front-panel controls by the LOCAL LOCKOUT command.
    - If so, send the LOCAL command from the external controller.
  - Press .
- Check whether the **Key Lock** annunciator is ON.
  - Check whether the handler or the 16064B LED display/trigger box is connected to the 4338B and it locks out the keys.
    - If so, unlock the keys from the handler or the 16064B.
  - Press  .

## Function Reference

---

### Introduction

This chapter provides information on all of the 4338B's functions.

- Front Panel
- Rear Panel
- Theory of Operation



## Front Panel

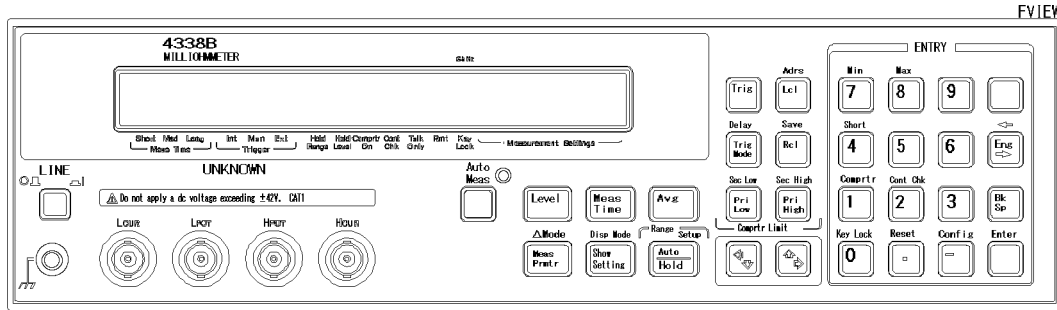



Figure 3-1. Front Panel

**Note**



In this manual, the BLUE shift key is expressed as , top of the key is not labeled with “blue”.

### Display

The display has two functions — the character display and an annunciator display.

The character display displays the measurement result, setting data, and instrument messages. The 4338B has four measurement display modes. For details on the display modes, refer to “Display Mode Key  ”.

The annunciator () points to the current setting of the 4338B. The annunciators are:

- Meas Time** (Measurement Time) indicates measurement time — Short, Medium or Long.
- Trigger** indicates the trigger mode — Internal, Manual, or External.
- Hold Range** shows the measurement range mode — Hold (when the annunciator is displayed) or Auto (when the annunciator is not displayed).
- Hold Level** indicates that the 4338B is in the Hold level mode. When in the Auto level mode, the Hold level annunciator is not displayed.
- Cmprtr On** (Comparator On) indicates the comparator function is ON.
- Cont Chk** (Contact Check On) indicates the contact check function is ON.
- Talk Only** (Talk Only mode) indicates the 4338B is performing an GPIB input or output data transfer.
- Rmt** (Remote) indicates the 4338B is in the GPIB remote mode.
- Key Lock** indicates the 4338B’s front panel keys are disabled.
- Shift** indicates the secondary key functions (printed above the keys in BLUE characters) are the active functions.

## LINE Switch

Power ON/OFF switch. In the 1 (ON) position power is applied and all operating voltages are applied to the instrument. In the 0 (OFF) position no power is applied and no operating voltages are applied to the instrument.

The 4338B's settings are held in backup memory for 72 hours after power is turned OFF, and are restored as the current settings when power is turned ON again within the 72 hours period. The backed up settings are:

- Auto level mode
- Test signal level
- Source delay
- Measurement parameter
- Deviation mode
- Deviation reference value
- Auto / Hold range mode
- Measurement range setting
- Measurement time
- Averaging
- Trigger mode
- Trigger delay
- Comparator ON/OFF state
- High and low limit value
- Display mode

## Chassis Terminal

The Chassis terminal is tied to the instrument's chassis.



### UNKNOWN Terminals

These terminals are used to connect test fixtures or test leads for measuring a DUT. The connector type is BNC.



---

**Caution** DO NOT apply a dc voltage exceeding  $\pm 42$  V to UNKNOWN terminals, or the 4338B's input circuits will be destroyed.



## Auto Measurement Key

The Auto Measurement key enables the Auto measurement function which allows the 4338B to measure a DUT automatically using the optimum measurement range and test signal level.

When the auto measurement function enabled, the 4338B is set to the auto range mode (see "Auto / Hold range Key ) and auto level mode (see "Level Key )").

When the Auto measurement function is enabled, the Auto Measurement indicator turns ON.

---

**Note**  The Auto Measurement key doesn't disable the Auto measurement function. And the Auto measurement function is disabled when auto range or auto level is disabled.

**Level Key** 

The level key sets the test signal level. The available test signal levels are 1  $\mu$ Arms, 10  $\mu$ Arms, 100  $\mu$ Arms, 1 mArms, and 10 mArms. Figure 3-2 shows the available measurement range for each test level.

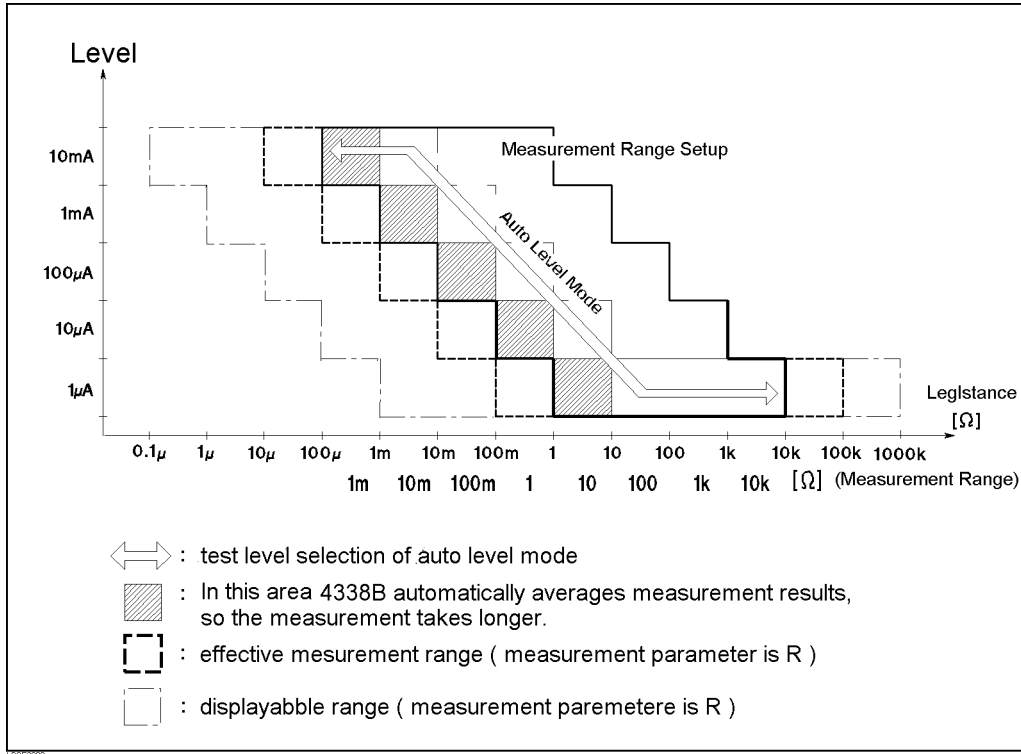

**Figure 3-2. Test Level and Measurement Range Setup**

If the measurement range setting doesn't match the test signal level you choose, the 4338B selects the nearest measurement range from the current setting that satisfies the measurement limits for the selected test signal level.

The level key can also select the auto level mode. In the auto level mode, the test signal level is linked to the measurement range settings as follows:

<b>Range</b>	10 k $\Omega$	1 k $\Omega$	100 $\Omega$	10 $\Omega$	1 $\Omega$	100 m $\Omega$	10 m $\Omega$	1 m $\Omega$
<b>Level</b>	1 $\mu$ A			10 $\mu$ A	100 $\mu$ A	1 mA	10 mA	

When the auto level mode is not selected, the Hold level annunciator is displayed.

**Note**



The 4338B's test signal output is enabled when a measurement is triggered, and disabled when the measurement is completed (See "Delay Key").

**Note**

The peak voltage across the DUT must always be less than 20 mV. When the peak voltage across the DUT exceeds 20 mV, the source output level goes to 0 V, and the 4338B displays “0VV0L”. For details, see “Dry Circuit Loop” in Chapter 7.

**Measurement Parameter Key**

The Measurement Parameter key selects the measurement parameter. The 4338B has the following measurement parameters:

R (default)  
 R-L (series circuit)  
 R-X  
 Z- $\theta$

Where,

R	Resistance
L	Inductance
X	Reactance
Z	Absolute value of Impedance
$\theta$	Phase Angle(deg)

**Deviation Mode Key**



The Deviation mode ( $\Delta$  mode) key selects the deviation measurement mode which displays the difference between the measured value a user entered nominal value and sets the nominal value of the deviation measurement.

- $\Delta$  ABS mode** displays the difference between the measured value and the nominal value.
- $\Delta$  % mode** displays the difference between the measurement value and the nominal value as a percentage of the nominal value.
- Off** turns OFF the deviation measurement mode. (default)

**Measurement Time Key**

The Measurement Time key toggles the measurement time between Short, Medium, and Long. The current setting is indicated by the **Meas Time** annunciator(▼). While a Short measurement time setting gives the shortest measurement time, a Long measurement time will give the more accurate result. The default measurement time is Medium.

**Show Setting Key**

The Show Setting Key displays the current settings of the 4338B. The settings are sequentially displayed on the right side of the LCD display (Measurement Settings area) each time  is pressed. The following information is displayed:

- Test signal level and Averaging rate
- Trigger delay time and Source delay time
- Comparator limits of the primary parameter
- Comparator limits of the secondary parameter

**Display Mode Key** 

The Display Mode key sets the 4338B to one of the following four display modes:

- Data** displays the measurement result. (default)
- Comprtr** displays the result message of the comparator as HIGH(grater than the upper limit), IN(passed), LOW(less than the lower limit) and N.C.(contact check fail).
- Off** does not display any measurement result (Display OFF).

Also, if you select Digit in this menu, you can set the number of digits for the measurement data. The available digits are 3, 4, and 5.

**Average Key** 

The Average key sets the measurement averaging rate. The 4338B averages the measurement results automatically. The averaging rate can be set from 1 to 256. The default averaging rate is 1.

**Auto / Hold range Key** 

The Auto/Hold range key toggles the measurement ranging mode between Auto and Hold. The Auto mode selects the optimum measurement range automatically within 5 measurement cycles. The Hold mode fixes the measurement range setting to the range you select. When the Hold mode is selected, the **Hold Range** annunciator(▼) will be displayed. The default measurement range mode is Auto.

**Range Setup Key** 

The Range setup key sets the measurement range. The available measurement range settings are 1 mΩ, 10 mΩ, 100 mΩ, 1 Ω, 10 Ω, 100 Ω, 1 kΩ, and 10 kΩ, which are limited by test level setting. (See Figure 3-2.)

When the measured impedance is out of range and the 4338B cannot measure at the currently set range setting, “OVLD” is displayed.

**Trigger Key** 

The Trigger key triggers a measurement when in the manual trigger mode. (see “Trigger Mode Key ”).

### Trigger Mode Key

The Trigger mode key toggles three trigger mode – Internal, Manual, or External. The 4338B also has a BUS trigger mode.

**Internal (Int)** The internal trigger mode. In this mode measurements are free running and continuous. (Default)

**Manual (Man)** The manual trigger mode. In the manual mode, the 4338B performs a single measurement when the front-panel  key is pushed.

**External (Ext)** The external trigger mode. The 4338B is triggered by a TTL pulse input through the rear panel External Trigger connector, or through the handler interface. For more information, refer to “External Trigger” in “Rear Panel”.

**Bus mode (GPIB only)** This mode is available only when in the GPIB remote state. In the BUS trigger mode, the GET and \*TRG commands will trigger a single shot measurement. For more information, refer to “TRIGger Subsystem” in Chapter 5.

The mode selected is indicated by the **Trigger** annunciator(▼). (In the BUS mode, the annunciator is not displayed).

### Delay Key

The Delay key sets the trigger delay time and the source delay time. The delay time specifies the time interval from the time at which the trigger occurs to the actual start of the measurement, as shown in Figure 3-3. Each delay time can be set 0 ms to 9999 ms with 1 ms resolution. The default delay time is 0 ms.

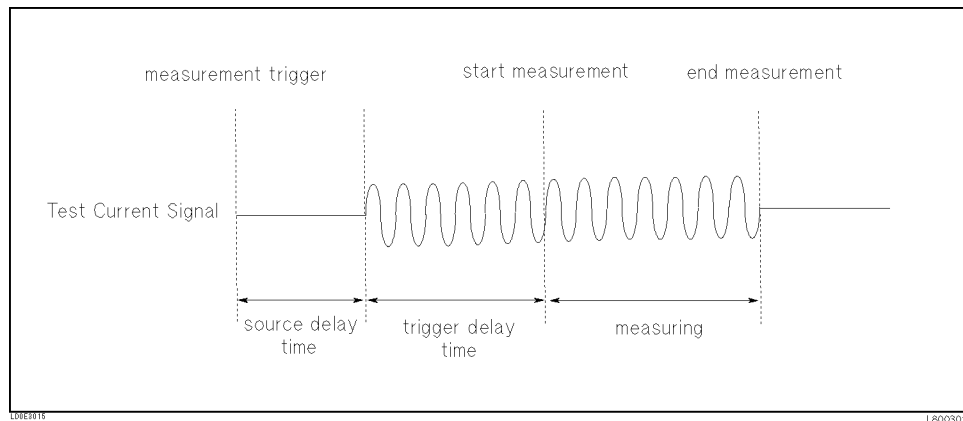

**Figure 3-3. Source Delay and Trigger Delay**

### Local Key

The Local key returns the 4338B to the local mode (front-panel) operation from the GPIB remote mode (computer controlled). This key is the only front-panel key activated while the 4338B is in the remote state.

When the 4338B is in the remote mode, the **Rmt** annunciator(▼) will be displayed.

### Address Key

The Address key sets the 4338B's GPIB address. The available GPIB addresses are the integer numbers from 0 to 30. Address 31 is the talk only mode in which the 4338B sends data through GPIB interface.

In the talk only mode, output data is,  
`<stat>,<data1>,<data2>,<comp1>,<comp2>`

Where,

- `<stat>` measured status of each channel
  - 0 : normal
  - 1 : overload
  - 2 : no contact
  - 4 : over voltage
- `<data1>` measurement data of primary parameter
- `<data2>` measurement data of secondary parameter  
 (Meaningless output when the secondary parameter is none)
- `<comp1>` comparison result of primary parameter  
 (No output when the comparator function is OFF)
- `<comp2>` comparison result of secondary parameter  
 (No output when the comparator function is OFF)  
 (Meaningless output when the secondary parameter is none)
  - 1 : In
  - 2 : High
  - 4 : Low
  - 8 : no contact

System reset or power-on don't affect the address setting.

### Save Key

The Save key stores the 4338B's current settings in non-volatile memory (EEPROM). The settings saved are the same as the backup settings listed in "LINE Switch" description. You must enter the register number, 0 to 9, to assign the register into which the settings will be saved. Up to 10 sets of instrument settings can be saved.

#### Caution







The 4338B overwrites the instrument's setting into the assigned register without notice, if settings are already stored in the assigned register, the settings will be lost when the new settings overwrite them.

### Recall Key

The Recall key recalls instrument's setting saved in non-volatile memory (EEPROM). You must enter the register number, 0 to 9, to assign the register from which the settings will be recalled.

If the register from which the settings are to be recalled is empty, the error message, "RECALL FAILED" is displayed.



### Primary and Secondary comparator limit Key

The comparator limit keys set the comparator high and low limit values which decides the comparator's PASS or FAIL response. If  /  is pressed, the primary parameter's lower / higher limit entry menu is displayed. If  /  is pressed, the secondary parameter's lower / higher limit entry menu is displayed.

You cannot set the limit values to OFF from the front-panel keys, but you can by using GPIB commands. See "CALCulate Subsystem" in Chapter 5.

### Left/Down Arrow Key and Right/Up Arrow Key

These keys serve the following functions:

- While 4338B is displaying several items, these keys are used to select (a selected item blinks continuously) adjacent items in the list (  selects the next item and the  selects the previous item).

### 0, 1, . . . , 9, –(minus), .(point) Key . . .

These keys are used to enter the numeric values of the 4338B's settings.

### Enter Key

The enter key terminates data input or setting value and returns to the measurement menu.

### BLUE Shift Key

The BLUE Shift key is a toggle action key which activates the secondary functions whose labels are printed above the keys. For example,

pressing   instructs the instrument to display the SHORT correction menu.



The BLUE shift key function is cleared by a single execution of a shifted function or by pressing the BLUE shift key again. The **Shift** annunciator(▼) is displayed when the BLUE shift key is toggled to the active mode.



**Engineering units Key** 

The Engineering units key enters engineering units. The available engineering units are:

f (femto)	$\times 10^{-15}$	k (kilo)	$\times 10^3$
p (pico)	$\times 10^{-12}$	M (mega)	$\times 10^6$
n (nano)	$\times 10^{-9}$	G (giga)	$\times 10^9$
$\mu$ (micro)	$\times 10^{-6}$	T (tera)	$\times 10^{12}$
m (milli)	$\times 10^{-3}$		

Press , the unit is displayed in increasing order. Press  , the unit is displayed in decreasing order.

**Back Space Key** 

The Back Space key deletes a single preceding character of an input value.

**Minimum Key**  

The Minimum key enters the minimum value during a setting operation.

**Maximum Key**  

The Maximum key enters the maximum value during a setting operation.

**Comparator Key**  

The Comparator key toggles the comparator function ON and OFF. The default comparator function is OFF.

The Comparator distinguishes whether or not the measurement result is within the upper and lower comparator limits for primary and secondary measurement parameter. When the comparator function is ON, the **Comprtr On** annunciator(▼) will be displayed. The comparison results output is assigned as follows:

<b>Destination</b>	<b>Condition</b>
Comparison Display	: HIGH, IN, LOW, N.C.
Handler Interface	: HIGH, IN, LOW, N.C.
Beep (FAIL mode)	: HIGH, LOW, N.C.
(PASS mode)	: IN

Where,

- HIGH greater than the upper limit
- IN between the upper limit and the lower limit
- LOW less than the lower limit
- N.C. contact check failed

When measurement parameter changes, the comparator function is automatically turned OFF.

## Contact Check Key

The contact check key toggles the contact check function ON and OFF. This function monitors whether the DUT is properly connected to the measurement terminals. When the no-contact is detected, the 4338B displays “N.C.”. The default state is OFF.

When the contact check function is ON, the **Cont Chk** annunciator(▼) will be displayed.

## Short Key

The Short key executes the SHORT correction function. The SHORT correction measurement must be performed when the high terminal and low terminals are directly shorted together or with a low-impedance, high-quality shorting device. The 4338B takes measurement data under these conditions and uses the correction data to cancel measurement errors due to the residual impedance of cable and test fixture. The correction data is stored in non-volatile memory(EEPROM).

Press  , the following SHORT correction menu is displayed.

- ShortMeas                      Performs the SHORT correction.
- MeasVal                        Displays the SHORT correction data (R, X).
- Exit                              Exits the menu.

If the short impedance,  $|Z_s|$ , is NOT less than 10  $\Omega$ , the 4338B displays,

“WARNING: Out Of Limit”

This is only a WARNING, the SHORT correction data will still be used.

When the “OVLD”, “OVVOL” or “N.C.” is displayed during the SHORT correction, the 4338B will display, “WARNING: Improper Correction”. When the contact check function is ON, the values of “9.9999E13” are stored as R and X in the MeasVal.

At reset, the correction data is cleared.

You cannot enable or disable the correction function without discarding the correction data when using the 4338B’s front-panel keys, but you can by using GPIB commands. See “[[:SENSE]:CORREction[:STATE] { ON | OFF | 1 | 0 }” in Chapter 5.



## Key Lock Key

The Key Lock key toggles disabling and enabling key input from the front panel. When the key input is disabled, the **Key Lock** annunciator(▼) will be displayed.

To cancel the key lock state, press this key again.

### Note



The key lock state can also be controlled through the handler interface. When the handler key lock function controls the key lock states, all the front-panel keys are locked out, including  , so you can only cancel the key lock out state from the handler.

## Reset Key

The Reset key resets the 4338B to the default state. The default states are following:

Auto measurement	: ON (Auto range and Auto level mode is enabled)
Source delay	: 0 ms
Measurement parameter	: R
Deviation measurement	: OFF
Measurement time	: MEDium
Averaging	: 1
Trigger mode	: Internal
Trigger delay	: 0 ms
Comparator	: OFF
Display mode	: Measured data
Display digits	: 5
Beep	: FAIL Beep
Short correction data	: Cleared
Contact Check	: OFF

## Configuration Key

The Configuration key is used to set the beep mode and the power line frequency setting, and to run the performance tests.

- **Beep** — Comparison results output to the beeper are classified as follows:

Off           no output to beeper.

Pass          emits a beep when the comparison result is IN.

Fail          emits a beep when the comparison result is HI, LO. (default)

In the beeper Pass or Fail mode, the 4338B emits a beep whenever a system error or an operation error occurs. In the beeper Off mode, the error beep is turned OFF.

The setting is saved into EEPROM.

- **Line** — Available power line frequency selections are 50 Hz and 60 Hz.

The power line frequency setting is stored and does not change after reset or power-off. Once you set it, you do not need to set the line frequency again as long as the power line frequency remains the same.

- **Svc** — There are five service functions.

KEY           test front-panel keys.

HN DL         test the handler output signal.

CSUM         run ROM check sum program.

RAM           read-write test RAM. After the test, the 4338B resets the instrument's settings.

EEPROM       test EEPROM. The data stored in EEPROM is not affected if no error is detected. If the error is detected, the 4338B clears the data and restores the default data.

- **Test** performs the self-test which tests the 4338B's basic performance and displays the results as the sum of all existing error codes.

item	result	error code
1. Beeper	beep once	-
2. Display	display all digits and segments	-
3. RAM	display error message if fail <sup>1</sup>	1
4. EPROM	display error message if fail <sup>1</sup>	2
5. Calibration data (EEPROM)	display error message if fail <sup>1</sup>	4
6. User's data (EEPROM)	display error message if fail <sup>2</sup>	8
7. A/D converter	display error message if fail <sup>1</sup>	16
8. Backup RAM	display error message if fail <sup>2</sup>	32

1 During the power-on test, the 4338B suspends operation if an error occurs

2 During the power-on test, the 4338B uses its default setting, and continues with the test.

The self-test is also executed at power-on. After the test, the 4338Bs settings are not affected.

- Exit return to measurement.

# Rear Panel

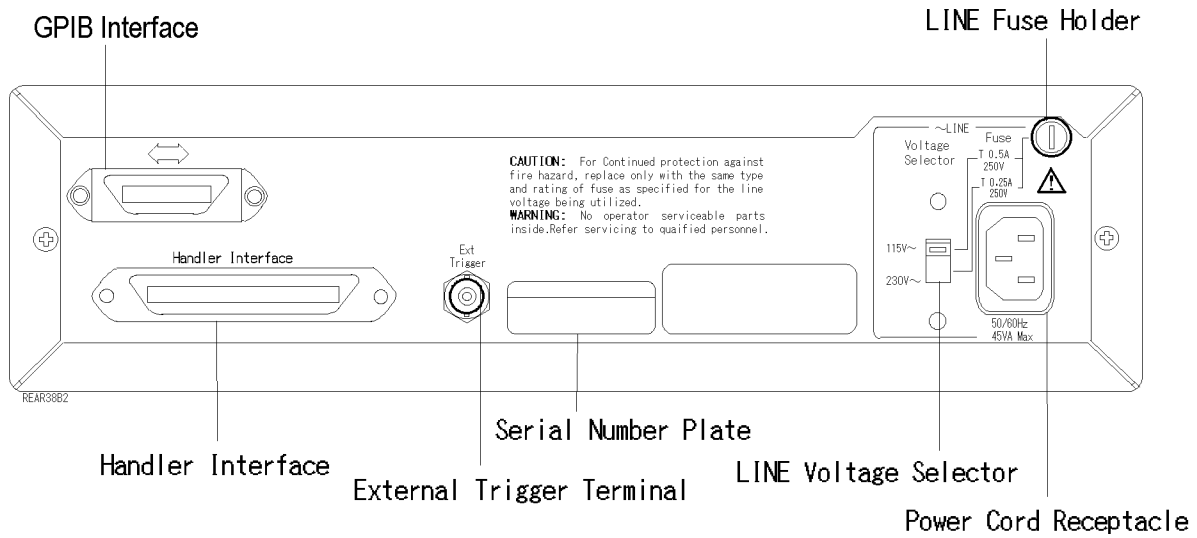

**Figure 3-4. Rear Panel**

## External Trigger

The EXT TRIGGER Terminal is used to input an External trigger signal. When the 4338B is set to the External trigger mode, the 4338B is triggered on the active-low to high rising edge of a TTL level input pulse. Figure 3-5 shows the specifications required of the TTL pulse.

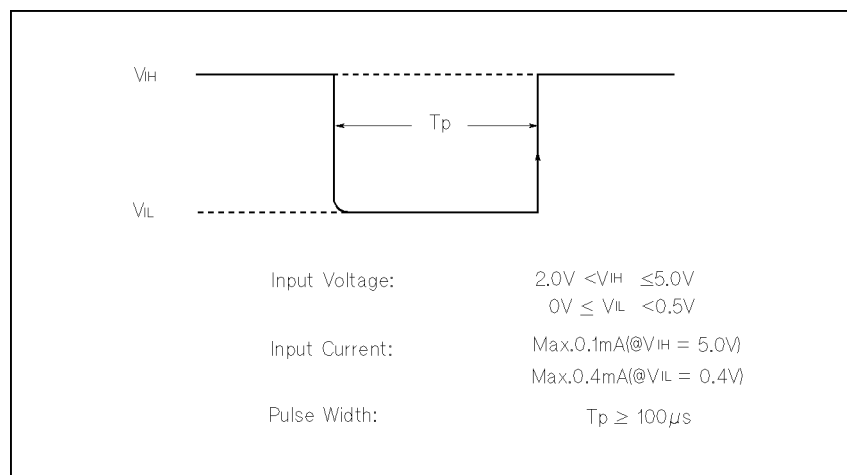

**Figure 3-5. Required External Trigger Pulse Specification**



### LINE Fuse Holder

Fuse holder for the 4338B's line fuse. The required fuse is selected depending on LINE Voltage Selector selection. Refer to Table 3-1.

### LINE Voltage Selector

The Line Voltage Selector switches the ac power source voltage selection. This is used to match the 4338B to the ac operating voltage being used. The line voltage selection is as follows:

**Table 3-1. Line Voltage selection**

Voltage Selector	Line Voltage	Required Fuse
115V	100/120Vac( $\pm 10\%$ )	UL/CSA type, Time delay 0.5A 250V (Agilent part number 2110-0202)
230V	220/240Vac( $\pm 10\%$ )	UL CSA type, Time delay 0.25A 250V (Agilent part number 2110-0201)

### Serial Number Plate

The serial number plate gives manufacturing information about the 4338B. For details, see "Serial Number" in Appendix A.

### Power Cord Receptacle

The Power Cord Receptacle is used to plug in the power cord.

### Power Code

The 4338B is equipped with a three-conductor power cord that, when plugged into the appropriate AC power receptacle, grounds the instrument. The offset pin on the power cord is the safety ground.

## Handler Interface

### Specification

Output signal: Negative true, open collector, opto-isolated

Decision Output:

Primary parameter Comparator High, In, Low

Secondary parameter Comparator High, In, Low

Contact check failed (N.C.).

Voltage across the DUT exceeds 20 mV, and source output goes to 0 V.

Index: Analog measurement complete

Measurement complete: Full measurement complete

Alarm: Notification that a momentary power failure was detected.

Input Signal: Opto-isolated

Keylock: Front panel keyboard lockout

External Trigger: Pulse width  $\geq 1 \mu\text{s}$

### Note



The comparator output signals High, In, Low, and the control signals /INDEX, /EOM are available when the comparator function is ON. And the contact check output signal N.C. is available when both the comparator and contact check functions are ON.

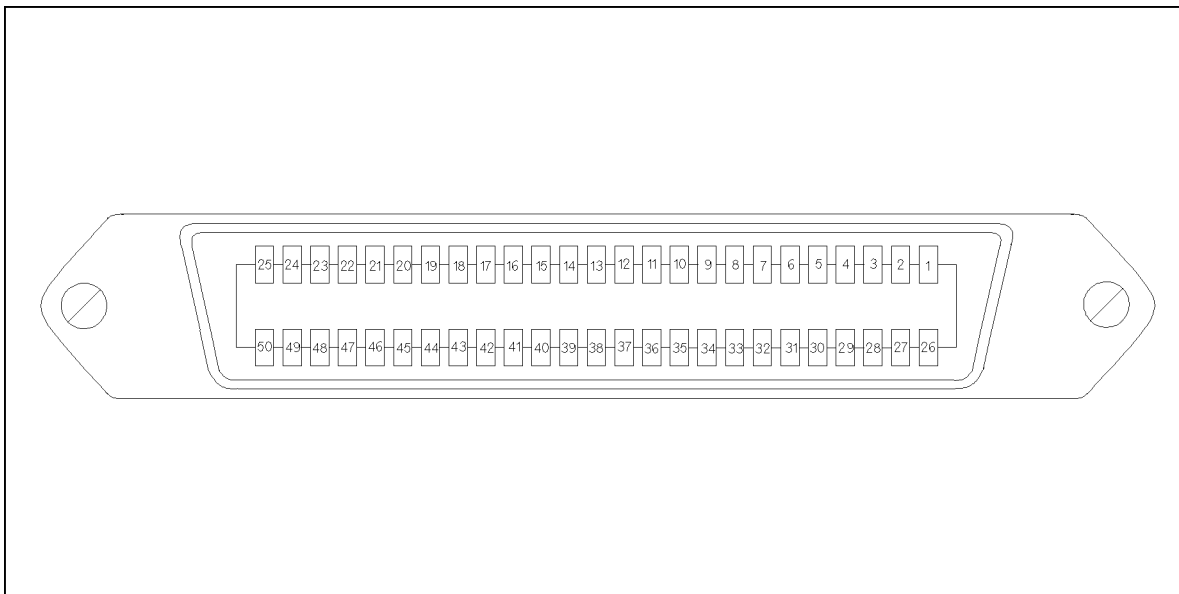

**Figure 3-6. Pin Assignment For Handler Interface Connector**

Table 3-2. Contact Assignment for Comparator Function

Pin No.	Signal Name <sup>1</sup>	Description
1	EXT DCV1	External DC Voltage 1: DC Voltage supply pins for DC isolated open collector outputs (/PHI, /SHI, /PIN, /SIN, /PLO, /SLO). The maximum voltage is +24V, the minimum +5V.
2	EXT DCV1	
18	/KEY LOCK	Key Lock: When this line is asserted, all of the 4338B's front panel key functions are disabled.
19	/EXT TRIG	External Trigger: 4338B is triggered on the rising edge of a pulse applied to this pin when the trigger mode is set to External.
20	EXT DCV2	External DC voltage 2: DC voltage supply pins for DC Isolated inputs (/EXT TRIG, /KEY LOCK) and DC Isolated outputs (/ALARM, /INDEX, /EOM). Maximum voltage is +15V, minimum +5V.
21	EXT DCV2	
24	+5 V	Internal voltage supply (max. output 0.1 A): Exceeding 0.1 A will cause the internal voltage to go to 0 V.
25	+5 V	
26	COM1	Common for EXT DCV1.
27	COM1	
28	/PHI	Primary Parameter High: The comparison result of primary parameter is HIGH.
29	/PIN	Primary Parameter In: The comparison result of primary parameter is IN.
30	/PLO	Primary Parameter Low: The comparison result of primary parameter is LOW.
31	/SHI	Secondary parameter High: The comparison result of secondary parameter is HIGH.
32	/SIN	Secondary parameter In: The comparison result of secondary parameter is IN.
33	/SLO	Secondary parameter Low: The comparison result of secondary parameter is LOW.
38	/OVVOL, or	Over Voltage: The test voltage across the DUT is exceeding 20 mV and source voltage output goes to 0 V.
	/N.C.	No Contact: Contact check failed.
42	/ALARM	Alarm: This signal is asserted on POWER DOWN of the 4338B. The signal length is 200 ms.
43	/INDEX	Index: This signal is asserted when an analog measurement is complete and the 4338B is ready for the next DUT to be connected to the UNKNOWN terminals. The measurement date, however, is not valid until /EOM is asserted.
44	/EOM	End of Measurement: This signal is asserted when the measurement data and comparison results are valid.
45	COM2	Common for EXT DCV2.
46	COM2	
49	GND	Ground tied to chassis.
50	GND	

<sup>1</sup> The / (slash) means that the signal is asserted when low.



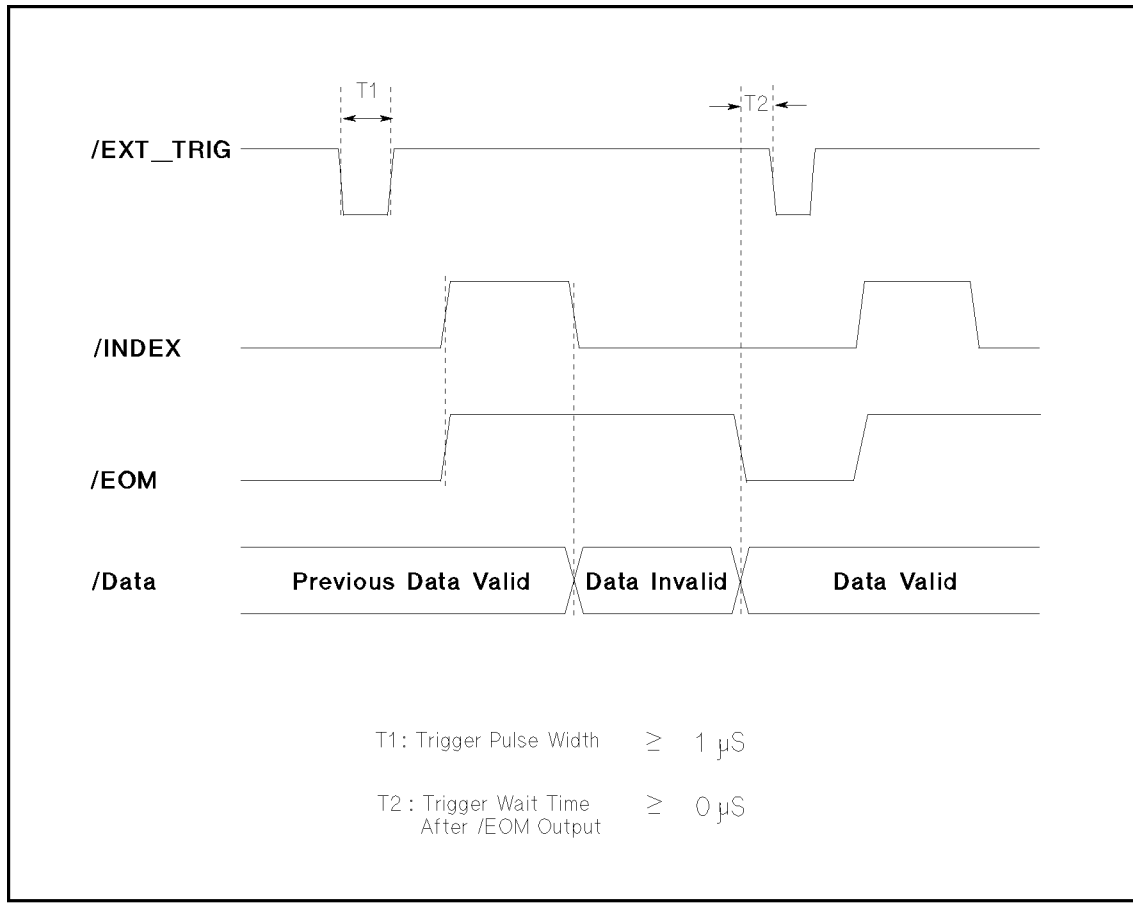

**Figure 3-7. Timing Diagram**

## GPIB Interface

GPIB Interface is used for remote control of the 4338B using the General Purpose Interface Bus (GPIB).

GPIB is an instrument interface standard which supports worldwide standards IEEE 488.1, IEC-625, IEEE 488.2, and JIS-C1901. The GPIB interface allows the instrument to be controlled by an external computer that sends commands or instructions to and receives data from the instrument via GPIB. It also defines handshaking, addressing, and the general protocol used for transmitting individual bytes of data between instruments and a controller.

With an GPIB system, many different types of devices including instruments, computers, plotters, and printers can be connected in parallel. When configuring an GPIB system, the following restrictions must be adhered to:

- The length of cable between two devices must be less than or equal to four meters. The total length of cable in one bus system must be less than or equal to two meters times the number of devices connected on the bus (the GPIB controller counts as one device) and the total length of cable must not exceed 20 meters.
- A maximum of 15 devices can be connected on one bus system.

- There are no restrictions on how the cables are connected together. However, it is recommended that no more than four piggyback connectors be stacked together on any one device. The resulting structure could exert enough force on the connector mounting to damage it.

Every GPIB device has a unique address for identification. The available GPIB addresses are the integer values 0 to 30. Any device on an GPIB bus must have a unique address otherwise there will be bus contention as devices with the same address try to use the bus at the same time.

Every GPIB device must be capable of performing one or more of the following interface functions:

Talker	A talker sends device-dependent data when it is addressed to talk. In an GPIB system, there can be only one active talker at any given time.
Listener	A listener receives device-dependent data when addressed to listen. In a GPIB system, there can be any number of active listener at any given time.
Controller	A controller manages the operation of the bus and addresses talker's and listener's. In an GPIB system, there can be only one active controller at any given time.

Table 3-3 lists the 4338B's GPIB capability and functions. These functions provide the means for an instrument to receive, process, and transmit commands, data, and status over the GPIB bus.

**Table 3-3. GPIB Interface Capability**

<b>Code</b>	<b>Function</b>
SH1	Complete Source Handshake capability
AH1	Complete Acceptor Handshake capability
T5	Basic Talker; serial poll; unaddressed if MLA; Talk-Only
L4	Basic Listener; unaddressed if MTA; no Listen Only
SR1	Service Request capability
RL1	Remote/Local capability
DC1	Device Clear capability
DT1	Device Trigger capability
C0	No Controller capability
E1	Drivers are open-collector

## Theory of Operation

This section discusses the 4338B's theory of operation.

### Overall Measurement Theory

The 4338B measures Device Under Test (DUT) impedance in the following manner:

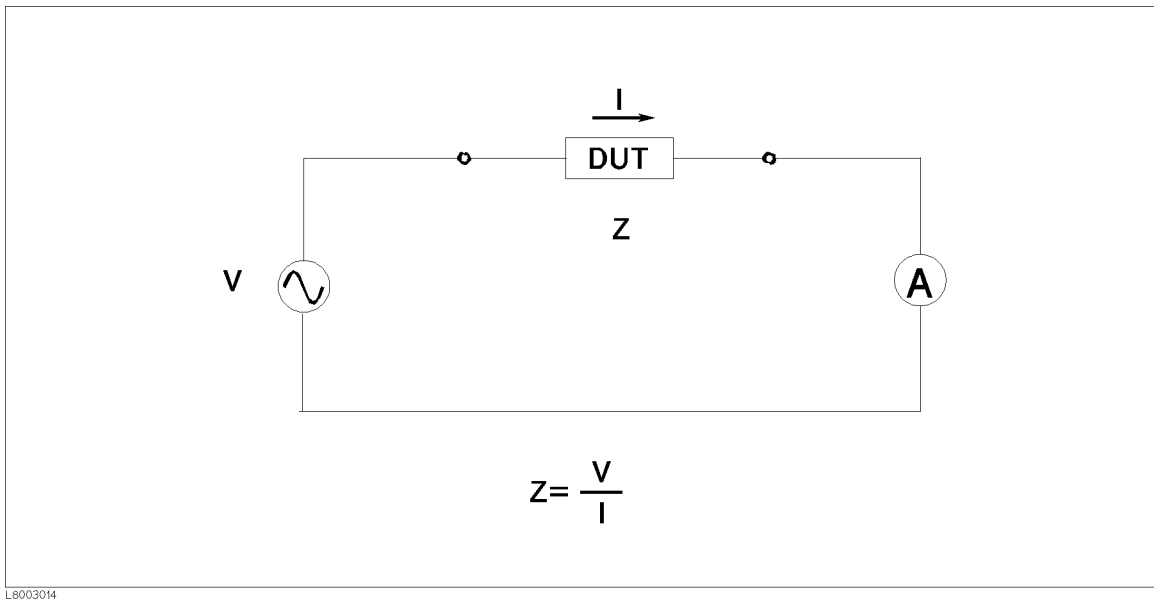
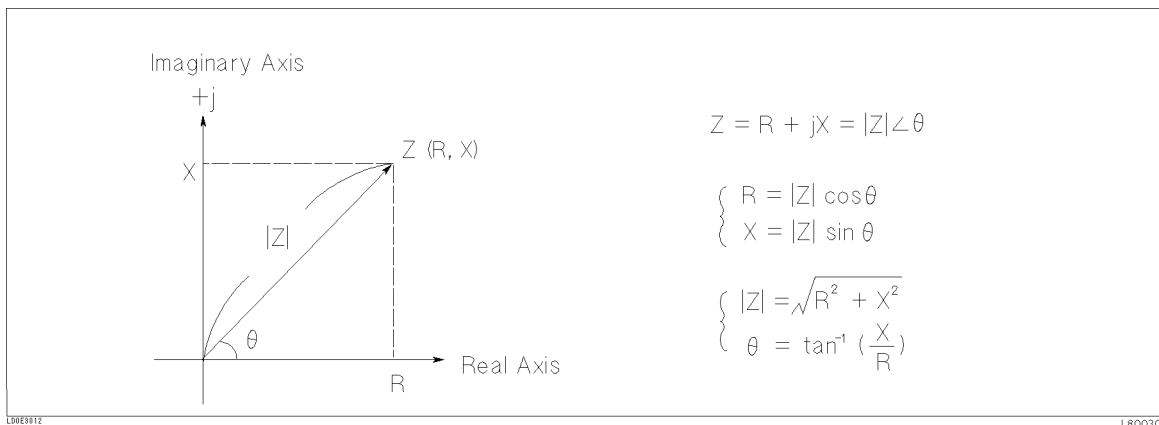

**Figure 3-8. Definition of Impedance**

Figure 3-8 shows the Impedance definition. If the current through the DUT is  $I$  when test voltage  $V$  is applied across the DUT, the DUT's impedance  $Z$  is expressed by,

$$Z = \frac{V}{I}$$

Impedance,  $Z$  contains a real and an imaginary part. Figure 3-9 shows vector representation of impedance.



**Figure 3-9. Vector Representation of Impedance**

In Figure 3-9,

R : resistance  
 X : reactance  
 $|Z|$  : magnitude of impedance  
 $\theta$  : phase of impedance

The 4338B measures the DUT's impedance, Z, which is a vector value, and gives the result in the following measurement parameters:

R : resistance  
 X : reactance  
 L : inductance  
 Z ( $|Z|$ ) : magnitude of impedance  
 $\theta$  : phase of impedance

These parameters represent the DUT's electrical characteristics as Figure 3-10.

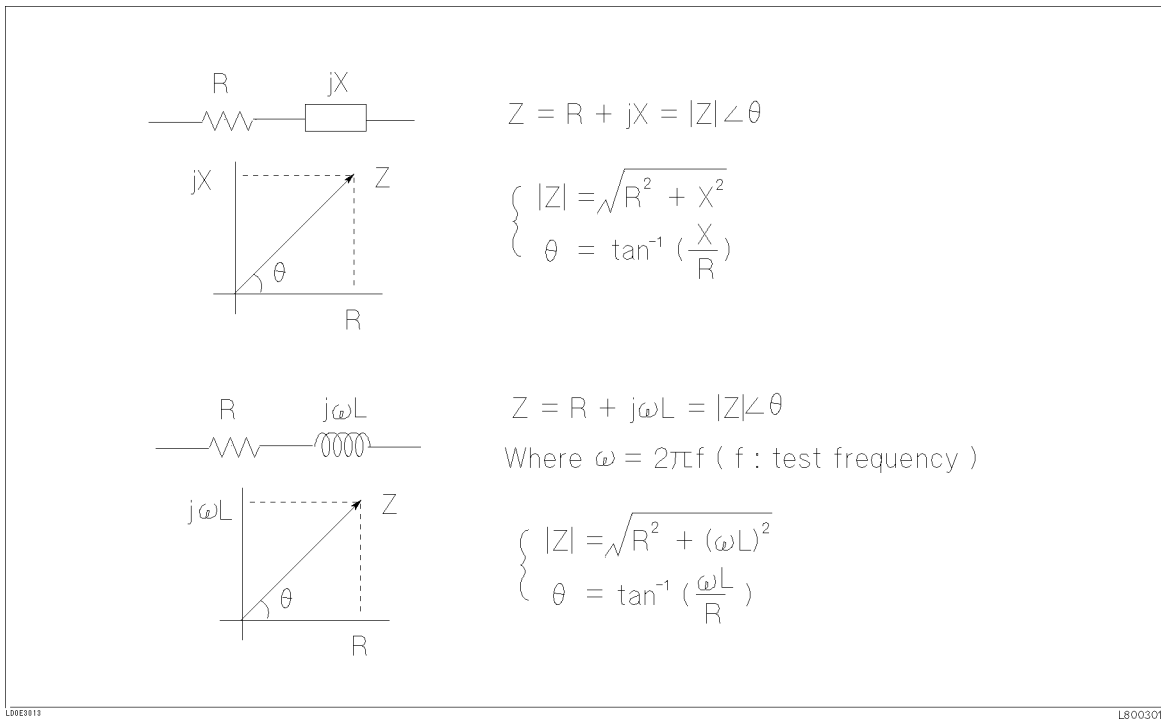
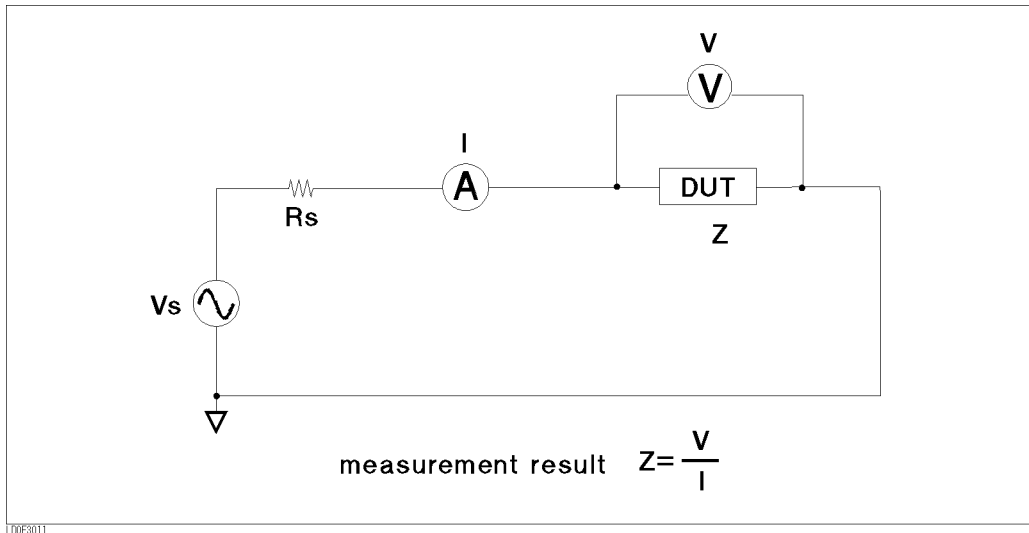

**Figure 3-10. Relationship between Measurement Parameters**

## Test Signal Level

### Actual Signal Level across DUT

Most components have impedance characteristics that are dependent on the applied signal level. So, the test level setting must be set appropriate for the DUT.



**Figure 3-11. Simplified Model of 4338B**

Figure 3-11 shows a simplified model of the 4338B. The 4338B can select test current levels of,  $1\mu\text{A}$ ,  $10\mu\text{A}$ ,  $100\mu\text{A}$ ,  $1\text{mA}$ , and  $10\text{mA}$ . The selection of test signal level decides the 4338B's test voltage source level,  $V_s$ , and its source resistance,  $R_s$ , as follows:

**Table 3-4. Source Voltage and Source Resistance**

Level	$1\mu\text{A}$	$10\mu\text{A}$	$100\mu\text{A}$	$1\text{mA}$	$10\text{mA}$
$V_s$	11mV				110mV
$R_s$	$11110\Omega$	$1110\Omega$	$110\Omega$	$10.1\Omega$	$10.1\Omega$

The signal level across the DUT depends on the test voltage source level,  $V_s$ , the source resistance of the 4338B,  $R_s$ , and the impedance of the DUT,  $R_{DUT}$ , as follows:

$$I = \frac{V_s}{R_s + R_{DUT}}$$

If the DUT's resistance is low enough to be assumed as 0 when compared with  $R_s$ , the test current level,  $I$ , will be close to the selected level. If DUT's resistance is high and cannot be assumed to be 0 when compared with  $R_s$ , the test signal level will differ from the selected test signal level. For example, to measure resistance  $20\Omega$ , with a  $100\mu\text{A}$  test signal level, the actual signal level across the DUT will be  $85\mu\text{A}$  ( $\frac{11\text{mV}}{110\Omega + 20\Omega}$ ).

### Limitation of Test Level

The 4338B automatically sets the test signal level to 0 V when the test voltage across the DUT exceeds 20 mV. For more information, see "Dry Circuit Loop" in Chapter 7.

## Remote Operation

---

### Introduction

This chapter provides step-by-step instructions for controlling the 4338B using GPIB remote mode. The examples in this manual use the HP 9000 series 200 or 300 BASIC language. This chapter covers the following:

- Getting started
- Setting up the 4338B
- Triggering a measurement
- Retrieving measurement data
- Other features
- If you have a problem

Refer to Chapter 5 for the description of each GPIB command.

---

#### Note



This chapter is not intended to teach BASIC programming language or the Standard Commands for Programmable Instruments (SCPI) programming, or to discuss GPIB theory; refer to the following documents which are better suited for these tasks.

For more information concerning BASIC, refer to the manual set for the BASIC version being used:

*BASIC Programming Techniques*  
*BASIC Language Reference*

For more information concerning SCPI, refer to the following:

*Beginner's Guide to SCPI*

For more information concerning GPIB operation, refer to the following:

*BASIC Interfacing Techniques*  
*Tutorial Description of the General Purpose Interface Bus*  
*Condensed Description of the General Purpose Interface Bus*

---

## Getting Started

This section will teach you the basics of operating the 4338B in the GPIB remote mode (from now just referred to as remote). This includes reading the GPIB address, sending a command to the 4338B, and retrieving data from the 4338B.

### Input/Output Statements

The statements used to operate the 4338B in remote depend on the computer and the programming language being used. In particular, you need to know the statements the language uses to input and output information. For example, the input statements for the HP 9000 series 200 or 300 BASIC language are:

ENTER or TRANSFER

The output statement is:

OUTPUT

Read your computer manuals to find out which statements you need to use.

### Reading the GPIB Address

Before you can operate the 4338B in remote, you need to know its GPIB address (factory setting=17). To check the address, press  . A typical display is:

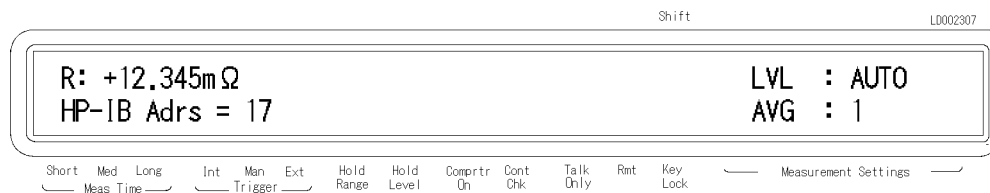

The displayed response is the device address. When sending a remote command, you append this address to the GPIB interface's select code (normally 7). For example, if the select code is 7 and the device address is 17, the appended combination is 717.

Every device on the GPIB bus must have a unique address. You can assign new GPIB addresses.



### Sending a Remote Command

To send a remote command to the 4338B, combine the computer's output statement with the GPIB select code, the device address, and finally the 4338B command. For example, to reset the 4338B, send:

```
OUTPUT 717;"*RST"
```

Notice that the **Rmt** annunciator(▼) is ON. This means the 4338B is in the remote mode.

## Returning to the Local Mode

When you press a key on the 4338B's keyboard while operating in remote, the 4338B does not respond. This is because the 4338B is in remote (as indicated by the display's **Rmt** annunciator) and is ignoring all front panel inputs but the  key. To return the 4338B to the Local mode, press the .

## Query Commands

There are several commands in the alphabetic command directory that end with a question mark. These commands are called query commands because each returns a response to a particular question.

In addition to the queries described above, you can create others by appending a question mark to most commands.

## Getting Data from the 4338B

The 4338B can output readings and responses to query commands. As an example, have the 4338B generate a response to a query command by sending:

```
OUTPUT 717; "*IDN?"
```

When you send a query from remote, the 4338B does not display the response as it did when you executed the command from its front panel. Instead, the 4338B sends the response to its output buffer. The output buffer is a register that holds a query response or data for a single measurement until it is read by the computer or replaced by new information. Use the computer's input statement to get the response from the output buffer. For example, the following program reads the response (4338B) and prints it.

```
10 ENTER 717; A$
20 PRINT A$
30 END
```



## To Control the 4338B from an External Computer

Most measurements can be modeled on the following simple three step sequence:

1. Set up the instrument.

Typically, you begin the setup step by sending \*RST to set the instrument to its default settings. Next, if you need values different from the default settings, change the settings one by one as required.

2. Trigger the measurement.

The trigger may be generated automatically by steps taken in your setup commands, or you can send an explicit trigger command. To select the trigger source, send the :TRIG:SOUR command with the trigger source parameter. When you select BUS as the trigger source, sending \*TRG triggers a measurement and retrieves the measurement data.

3. Retrieving the data.

The following sections describes how to perform the tasks at each step.

Figure 4-1 shows a simple capacitance measurement program.

```

:
! Step 1
OUTPUT 717;"*RST"           Resetting
OUTPUT 717;":INIT:CONT ON"  Initiating trigger system
OUTPUT 717;":CALC1:FORM REAL" Primary parameter: R
OUTPUT 717;":CALC2:FORM NONE" Secondary parameter: None
OUTPUT 717;":TRIG:SOUR BUS"  Trigger source: Bus
! Step 2
OUTPUT 717;"*TRG"           Triggering
! Step 3
ENTER 717;S,D1,D2           Retrieving data
:

```

**Figure 4-1. Simple Program Example**

---

## To Set Up the 4338B

### To Reset the 4338B

The following commands reset the 4338B:

- \*RST
- :SYST:PRES

---

**Note**            \*RST resets the trigger system also.



For example,

```
OUTPUT 717; "*RST"
```

### To Set the LINE Frequency

The following command sets the LINE frequency:

- :SYST:LFR

For example, to set the LINE frequency to 50 Hz,

```
OUTPUT 717; "SYST:LFR 50"
```

### To Perform the SHORT Correction

The following commands perform the SHORT correction:

- :SENS:CORR:COLL STAN2
- :SENS:CORR

For example, to perform the SHORT correction,

```
:
OUTPUT 717; ":SENS:CORR:COLL STAN2"
OUTPUT 717; "*OPC?"
ENTER 717; A
:
```

### To Select the Measurement Parameter

The following commands select the measurement parameter:

- :CALC1:FORM
- :CALC2:FORM

For example, to select the R only mode,

```
OUTPUT 717; ":CALC1:FORM REAL"
OUTPUT 717; ":CALC2:FORM NONE"
```

For example, to select the R-X mode,

```
OUTPUT 717; ":CALC1:FORM REAL"
OUTPUT 717; ":CALC2:FORM IMAG"
```

For example, to select the R-L mode,

```
OUTPUT 717;":CALC1:FORM REAL"  
OUTPUT 717;":CALC2:FORM LS"
```

For example, to select the Z- $\angle$  mode,

```
OUTPUT 717;":CALC1:FORM MLIN"  
OUTPUT 717;":CALC2:FORM PHAS"
```

### **To Select the Auto Measurement Mode**

The following commands select the auto measurement mode:

- :SOUR:CURR:RANG:AUTO
- :SENS:FIMP:RANG:AUTO

For example,

```
OUTPUT 717;":SOUR:CURR:RANG:AUTO ON"  
OUTPUT 717;":SENS:FIMP:RANG:AUTO ON"
```

### **To Select the Measurement Range**

The following commands select the measurement range:

- :SENS:FIMP:RANG
- :SENS:FIMP:RANG:AUTO

For example, to select the auto range mode,

```
OUTPUT 717;":SENS:FIMP:RANG:AUTO ON"
```

For example, to select the 1  $\Omega$  range,

```
OUTPUT 717;":SENS:FIMP:RANG:AUTO OFF"  
OUTPUT 717;":SENS:FIMP:RANG 1"
```

### **To Select the Test Signal Level**

The following commands select the test signal level:

- :SOUR:CURR
- :SOUR:CURR:AUTO

For example, to select the auto level mode,

```
OUTPUT 717;":SOUR:CURR:AUTO ON"
```

For example, to select 100  $\mu\text{A}$ ,

```
OUTPUT 717;":SOUR:CURR:AUTO OFF"  
OUTPUT 717;":SOUR:CURR 1E-4"
```

### **To Set the Measurement Time Mode**

The following command sets the measurement time mode:

- :SENS:FIMP:APER

To set the measurement time to SHORT,

```
OUTPUT 717;":SENS:FIMP:APER 0.034"
```

To set the measurement time to MEDIUM,

```
OUTPUT 717;":SENS:FIMP:APER 0.07"
```

To set the measurement time to LONG,

```
OUTPUT 717;":SENS:FIMP:APER 0.9"
```

### **To Set the Averaging Rate**

The following commands set the averaging rate:

- :SENS:AVER
- :SENS:AVER:COUN

For example, to set the averaging rate to 4,

```
OUTPUT 717;":SENS:AVER 4"
```

### **To Set the Delay Time**

The following commands set the delay time:

- :TRIG:DEL
- :TRIG:SEQ2:DEL

For example, to set the trigger delay time to 10 ms,

```
OUTPUT 717;":TRIG:SEQ2:DEL 1E-2"
```

For example, to set the source delay time to 10 ms,

```
OUTPUT 717;":TRIG:DEL 1E-2"
```

### **To Set the Beeper Mode**

The following commands set the beeper mode:

- :CALC{1|2}:LIM:BEEP
- :CALC{1|2}:LIM:BEEP:COND
- :SYST:BEEP
- :SYST:BEEP:STAT

For example, to set the beeper mode to emit a beep when the comparison result is PASS.

```
OUTPUT 717;":CALC1:LIM:BEEP PASS"
```

## To Use Comparator Function

The following commands control the comparator function:

- :CALC{1|2}:LIM:CLE
- :CALC{1|2}:LIM:FAIL?
- :CALC{1|2}:LIM:LOW
- :CALC{1|2}:LIM:LOW:STAT
- :CALC{1|2}:LIM:UPP
- :CALC{1|2}:LIM:UPP:STAT
- :CALC{1|2}:LIM:STAT

{1|2} shows that one of the two numbers is attached to the root mnemonic; 1 means the primary parameter and 2 means the secondary parameter.

For example, to set the limit values for the primary parameter, and to enable the comparator function,

```

:
OUTPUT 717;":CALC1:LIM:LOW 1E-2; UPP 1E-1"
OUTPUT 717;":CALC1:LIM:STAT ON"
:

```

## To Display a Deviation Measurement

The following commands displays a deviation measurement:

- :DATA
- :CALC{1|2}:MATH:EXPR:NAME
- :CALC{1|2}:MATH:EXPR:CAT?
- :CALC{1|2}:MATH:STAT

{1|2} shows that one of the two numbers is attached to the root mnemonic; 1 means the primary parameter and 2 means the secondary parameter.

For example, to set the reference values using the measured values, and to calculate the absolute value of deviation for the primary parameter,

```

:
OUTPUT 717;":FETC?"
ENTER 717;s,d1,d2
OUTPUT 717;":DATA REF1,";d1
OUTPUT 717;":CALC1:MATH:EXPR:NAME DEV"
OUTPUT 717;":CALC1:MATH:STAT ON"
:

```

## To Wait Until Previously Sent Commands are Completed

The following commands make the 4338B wait until the previously sent commands are completed:

- \*OPC
- \*OPC?
- \*WAI

For example, to wait until the OPEN correction is completed,

```

OUTPUT 717;":SENS:CORR:COLL STAN2"   Perform SHORT Correction
OUTPUT 717;":*OPC?"                 Wait for Open Correction completed
ENTER 717;A

```

**To Get the Current Instrument Settings**

The following command gets the current instrument settings:

- \*LRN?

For example,

```
DIM A$[1000]
:
OUTPUT 717;"*LRN?"
ENTER 717;A$
PRINT A$
```

**To Save and Recall Instrument Settings**

The following commands save and recall instrument settings:

- \*SAV
- \*RCL

To save the instrument settings to register no. 1,

```
OUTPUT 717;"*SAV 1"
```

To recall the instrument settings from register no. 1,

```
OUTPUT 717;"*RCL 1"
```

## To Trigger a Measurement

The following commands are used to trigger measurements from an external controller and to handle the 4338B's trigger system. Refer to "Trigger System" in Chapter 5 for the information about the 4338B's trigger system.

- :TRIG
- :TRIG:SOUR
- :INIT
- :INIT:CONT
- :ABOR
- \*TRG
- :FETC?
- Group Execution Trigger (GET)

**Follow the procedure below to perform successive measurements automatically (initial setup).**

1. Set the trigger mode to the internal trigger with the **:TRIG:SOUR** command.
2. If the trigger system has not started up (in the idle state), use the **:INIT:CONT** command to turn ON the continuous activation of the trigger system.

**Two methods to perform a measurement at your desired time:**

### Triggering the instrument at your desired time

1. Use the **:TRIG:SOUR** command to set the trigger mode to the GPIB mode.
2. If the trigger system has not started up (in the idle state), use the **:INIT:CONT** command to turn ON the continuous activation of the trigger system.
3. Trigger the instrument at your desired time. An external controller can trigger the instrument with one of the following two commands:

Command	Query response	Applicable trigger mode
<b>*TRG</b>	Yes (The measured result is read out.)	GPIB trigger
<b>:TRIG</b>	No	All

4. To repeat measurement, repeat Step 3.

### Starting up the trigger system at your desired time

1. If the trigger system has started up (in a state other than the idle state), use the **:INIT:CONT** command to turn OFF the continuous activation of the trigger system and then use the **:ABOR** command to stop the trigger system.
2. Set the trigger mode to the internal trigger with the **:TRIG:SOUR** command.
3. Start up the trigger system with the **:INIT** command at your desired time. The instrument will be automatically triggered by the internal trigger and measurement will be performed once.
4. To repeat measurement, repeat Step 3.

## Waiting For Completion Of Measurement (detecting completion of measurement)

You can detect the status of the 4338B by using the status register, as described in this section. For information on the entire status report system (for example, information on each bit of the status register), refer to Chapter 5, “GPIB Reference.”

The measurement state is indicated by the operation status register (refer to Table 5-6 and Table 5-7). An SRQ (service request) is useful for detecting the completion of measurement in your program by using the information indicated by this register.

To detect the completion of measurement using SRQ, use the following commands.

- \*SRE
- :STAT:OPER:ENAB

The procedure is given below.

1. Make the setup so that the 4338B generates an SRQ if bit 4 of the operation status event register is set to 1.
2. Trigger the instrument to start a measurement.
3. Perform interrupt handling in the program when the SRQ occurs.

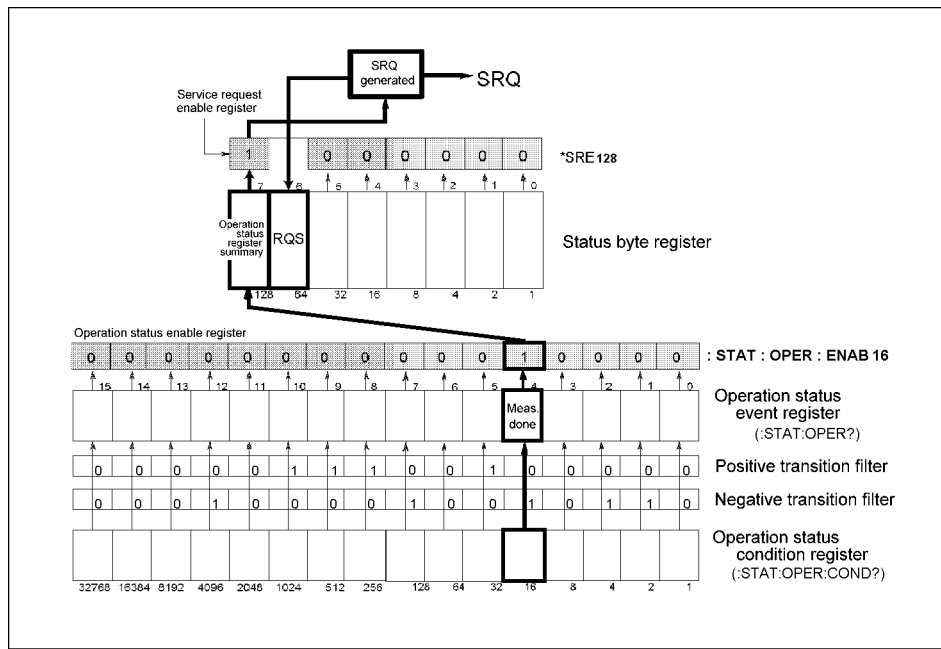

Id004006

Figure 4-2. SRQ generation sequence (when measurement finishes)



**Sample program**

Figure 4-3 shows a sample program to detect the completion of measurement using an SRQ.

This program stops the trigger system, sets up SRQ, and then starts up the trigger system once. When an SRQ of the completion of the measurement occurs, it displays a "Measurement Complete" message and finishes.

The program is detailed below.

Line 20	Sets the GPIB address.
Lines 40 to 60	Stops the trigger system and sets the trigger mode to the internal trigger.
Lines 80 to 90	Enables bit 4 of the operation status event register and enables bit 7 of the status byte register.
Lines 100 to 120	Clears the status byte register and operation status event register.
Lines 140 to 150	Sets the branch destination of the SRQ interrupt and enables the SRQ interrupt.
Lines 160 to 180	Starts up the trigger system once to start the measurement and waits for the completion of the measurement.
Line 230	Displays "Measurement Complete" message.

```

10    DIM Buff$(9)
20    ASSIGN @Agt4338b TO 717
30    !
40    OUTPUT @Agt4338b ; " : INIT:CONT OFF"
50    OUTPUT @Agt4338b ; " : ABOR"
60    OUTPUT @Agt4338b ; " : TRIG:SOUR INT"
70    !
80    OUTPUT @Agt4338b ; " : STAT:OPER:ENAB 16"
90    OUTPUT @Agt4338b ; " * SRE 128"
100   OUTPUT @Agt4338b ; " * CLS"
110   OUTPUT @Agt4338b ; " * OPC?"
120   ENTER @Agt4338b ; Buff$
130   !
140   ON INTR 7 GOTO Meas_end
150   ENABLE INTR 7 ; 2
160   OUTPUT @Agt4338b ; " : INIT"
170   PRINT "Waiting . . ."
180 Meas_wait : GOTO Meas_wait
190 Meas_end : OFF INTR 7
200   PRINT "Measurement Complete"
210   END

```

**Figure 4-3. Detecting the completion of measurement using SRQ**

## Reading Out Measured Result

This section describes how to read out the measured result.

You can read out the measured result in two ways: reading out data for each measurement or reading out data of several measurements in batch.

The three commands shown in the table below can be used to read out the measured data for each measurement.

	Available trigger mode	Readout procedure
Using the <b>*TRG</b> command	GPIB trigger (Bus)	Executing <b>*TRG</b> ↓ Readout
Using the <b>:FETC?</b> command	All	Triggering the instrument ↓ Executing <b>:FETC?</b> ↓ Readout

When you want to read out the data of several measurements in batch, use the data buffer.

### Note

The TRIGGER command of HT BASIC has the same function as the **\*TRG** command.



## Reading out measured result using \*TRG command

This command actually performs two tasks: it triggers the instrument and returns the results. It is useful, for example, when you want to retrieve measurement results immediately after triggering the instrument from an external controller.

The readout procedure using the \*TRG command is described below.

1. Use the **:TRIG:SOUR** command to set up the trigger mode to the GPIB trigger (Bus).
2. Execute the **\*TRG** command.
3. Read out the measured result. To repeat the measurement, repeat Steps 2 and 3.  
Figure 4-4 and Figure 4-5 show sample programs using the **\*TRG** command. Figure 4-4 is for the ASCII transfer format and Figure 4-5 is for the binary transfer format.

These programs read out the measurement status, measured primary parameter result, measured secondary parameter result, and comparator sorting result (when the comparator function is ON) and then display this information.

The program of Figure 4-4 is detailed below.

Line 60	Sets the GPIB address.
Line 70	Sets the data transfer format to the ASCII format.
Lines 90 to 100	Turns ON the trigger system continuous startup and sets the trigger mode to the GPIB trigger.
Lines 120 to 130	Reads out the ON/OFF state of the comparator function and assigns it to the Comp_flag variable.
Lines 170 to 210	After the trigger system state transitions to the trigger wait state, triggers the instrument.
Line 230	If the Comp_flag value is 1 (the comparator function is ON), reads out the measurement status, measured primary parameter result, measured secondary parameter result, and comparator sorting result.
Line 250	If the Comp_flag value is not 1 (the comparator function is OFF), reads out the measurement status, measured primary parameter result, and measured secondary parameter result.
Lines 300 to 320	Displays the measurement status, measured primary parameter result, and measured secondary parameter result.
Line 340 to 350	If the Comp_flag value is 1 (the comparator function is ON), displays the comparator sorting result.
Line 370	If the Comp_flag value is not 1 (the comparator function is OFF), displays "Comparator : OFF."

```

10 DIM Buff$ [9]
20 REAL Pri_para, Sec_para
30 INTEGER Meas_stat, Comp1, Comp2
40 INTEGER Comp_flag, Cond_reg
50 !
60 ASSIGN @Agt4338b TO 717
70 OUTPUT @Agt4338b ; " : FORM ASC"
80 !
90 OUTPUT @Agt4338b ; " : INIT:CONT ON"
100 OUTPUT @Agt4338b ; " : TRIG:SOUR BUS"
110 !
120 OUTPUT @Agt4338b ; " : CALC : LIM : STAT?"
130 ENTER @Agt4338b ; Comp_flag
140 !
150 ! Triggering and data read
160 !
170 REPEAT
180     OUTPUT @Agt4338b ; " : STAT : OPER : COND?"
190     ENTER @Agt4338b ; Cond_reg
200     UNTIL BIT(Cond_reg,5)
210     OUTPUT @Agt4338b ; " *TRG"
220     IF Comp_flag=1 THEN
230         ENTER @Agt4338b ; Meas_stat, Pri_para, Sec_para, Comp1, Comp2
240     ELSE
250         ENTER @Agt4338b ; Meas_stat, Pri_para, Sec_para
260     END IF
270     !
280     ! Display results
290     !
300     PRINT USING "15A, X, D" ; "Meas . status   :", Meas_stat
310     PRINT USING "15A, X, SD . 5DE" ; "Pri . parameter :", Pri_para
320     PRINT USING "15A, X, SD . 5DE" ; "Sec . parameter :", Sec_para
330     IF Comp_flag=1 THEN
340         PRINT USING "15A, X, K" ; "Primary Comparator   :", Comp1
350         PRINT USING "15A, X, K" ; "Secondary Comparator   :", Comp2
360     ELSE
370         PRINT USING "19A " ; "Comparator   : OFF"
380     END IF
390 END

```

**Figure 4-4.**

**Reading out the measured result in ASCII transfer format by using the \*TRG command**

The program of Figure 4-5 is detailed below.

- Lines 50 to 60      Sets the GPIB address.
- Line 70            Sets the data transfer format to the binary format.
- Lines 90 to 100    Turns ON the trigger system continuous startup and sets the trigger mode to the GPIB trigger.
- Lines 120 to 130   Reads out the ON/OFF state of the comparator function and assigns it to the Comp\_flag variable.
- Lines 170 to 210   After the trigger system state transitions to the trigger wait state, triggers the instrument.
- Lines 220 to 250   Reads out the header part.
- Line 270            If the Comp\_flag value is 1 (the comparator function is ON), reads out the measurement status, measured primary parameter result, measured secondary parameter result, and comparator sorting result.

---

**Note**            Binary data must be read out without formatting. Therefore, use an I/O path (@Binary) set up for such readout. This is also applicable to Line 290.



- 
- Line 290            If the Comp\_flag value is not 1 (the comparator function is OFF), reads out the measurement status, measured primary parameter result, and measured secondary parameter result.
  - Line 310            Reads out the message terminator at the end of the data.
  - Lines 350 to 370   Displays the measurement status, measured primary parameter result, and measured secondary parameter result.
  - Line 390 to 400    If the Comp\_flag value is 1 (the comparator function is ON), displays the comparator sorting result.
  - Line 420            If the Comp\_flag value is not 1 (the comparator function is OFF), displays "Comparator : OFF."

```

10  DIM Buff$ [9], Digit$ [1], Read_form$ [9], Num_of_byte$ [9]
20  REAL Pri_para, Sec_para
30  REAL Meas_stat, Comp1, Comp2
40  INTEGER Comp_flag, Cond_reg
50  ASSIGN @Binary TO 717 ; FORMAT OFF
60  ASSIGN @Agt4338b TO 717
70  OUTPUT @Agt4338b ; " : FORM REAL"
80  !
90  OUTPUT @Agt4338b ; " : INIT : CONT ON"
100 OUTPUT @Agt4338b ; " : TRIG : SOUR BUS"
110 !
120 OUTPUT @Agt4338b ; " : CALC : LIM : STAT?"
130 ENTER @Agt4338b ; Comp_flag
140 !
150 ! Triggering and data read
160 !
170 REPEAT
180   OUTPUT @Agt4338b ; " : STAT:OPER:COND?"
190   ENTER @Agt4338b ; Cond_reg
200  UNTIL BIT(Cond_reg, 5)
210  OUTPUT @Agt4338b ; " *TRG"
220  ENTER @Agt4338b USING "#, A" ; Buff$
230  ENTER @Agt4338b USING "#, A" ; Digit$
240  Read_form$="#, "&Digit$&"A"
250  ENTER @Agt4338b USING Read_form$ ; Num_of_byte$
260  IF Comp_flag=1 THEN
270    ENTER @Binary ; Meas_stat, Pri_para, Sec_para, Comp1, Comp2
280  ELSE
290    ENTER @Binary ; Meas_stat, Pri_para, Sec_para
300  END IF
310  ENTER @Agt4338b USING "#, A" ; Buff$
320  !
330  ! Display results
340  !
350  PRINT USING "15A, X, D" ; "Meas . status : " , Meas_stat
360  PRINT USING "15A, X, SD . 5DE" ; "Pri. parameter : " , Pri_para
370  PRINT USING "15A, X, SD . 5DE" ; "Sec . parameter : " , Sec_para
380  IF Comp_flag=1 THEN
390    PRINT USING "15A, X, K" ; "Primary Comparator  : " , Comp1
400    PRINT USING "15A, X, K" ; "Secondary Comparator  : " , Comp2
410  ELSE
420    PRINT USING "19A" ; "Comparator  : OFF"
430  END IF
440  END

```

Figure 4-5.

Reading out the measured result in binary transfer format using \*TRG command

## Reading out measured result using :FETC? command

You can use this readout method when you want to trigger the instrument from any source other than an external controller or when you want to perform a process that is between triggering the instrument and reading out the measured result.

The readout procedure using the **:FETC?** command is described below.

1. Set up the trigger mode as necessary.
2. Trigger the instrument by using the method for the trigger mode.

---

### Note

To trigger the instrument from an external controller in this procedure, use the **:TRIG** command.



3. Execute the **:FETC?** command at the completion of the measurement.
4. Read out the measured result. To repeat the measurement, repeat Steps 2 to 4.

Figure 4-6 and Figure 4-7 show sample programs using the **:FETC?** command. Figure 4-6 is for the ASCII transfer format and Figure 4-7 is for the binary transfer format.

These programs, when an external trigger is inputted and the measurement finishes, read out the measurement status, measured primary parameter result, measured secondary parameter result, and comparator sorting result (when the comparator function is ON) and display them.

The program of Figure 4-6 is detailed below.

Line 60	Sets the GPIB address.
Line 70	Sets the data transfer format to the ASCII format.
Lines 90 to 100	Turns ON the trigger system continuous startup and sets the trigger mode to the external trigger.
Lines 120 to 130	Reads out the ON/OFF state of the comparator function and assigns it into the Comp_flag variable.
Lines 170 to 210	Makes the setup generate an SRQ when measurement finishes and clears the status byte register and operation status event register.
Lines 250 to 260	Sets the branch destination of the SRQ interrupt and enables the SRQ interrupt.
Lines 270 to 280	Displays the message to prompt the user to input an external trigger and then waits until the external trigger is inputted and the measurement finishes.
Line 300	Executes the measured result readout command ( <b>:FETC?</b> ).
Line 320	If the Comp_flag value is 1 (the comparator function is ON), reads out the measurement status, measured primary parameter result, measured secondary parameter result, and comparator sorting result.
Line 340	If the Comp_flag value is not 1 (the comparator function is OFF), reads out the measurement status, measured primary parameter result, and measured secondary parameter result.
Lines 390 to 410	Displays the measurement status, measured primary parameter result, and measured secondary parameter result.
Line 430 to 440	If the Comp_flag value is 1 (the comparator function is ON), displays the comparator sorting result.
Line 460	If the Comp_flag value is not 1 (the comparator function is OFF), displays "Comparator : OFF."

```

10 DIM Buff$ [9]
20 REAL Pri_para,Sec_para
30 INTEGER Meas_stat,Comp1, Comp2
40 INTEGER Comp_flag
50 !
60 ASSIGN @Agt4338b TO 717
70 OUTPUT @Agt4338b ; " : FORM ASC"
80 !
90 OUTPUT @Agt4338b ; " : INIT : CONT ON"
100 OUTPUT @Agt4338b ; " : TRIG : SOUR EXT"
110 !
120 OUTPUT @Agt4338b ; " : CALC : LIM : STAT?"
130 ENTER @Agt4338b ; Comp_flag
140 !
150 ! SRQ setting
160 !
170 OUTPUT @Agt4338b ; " : STAT : OPER : ENAB 16"
180 OUTPUT @Agt4338b ; " *SRE 128"
190 OUTPUT @Agt4338b ; " *CLS"
200 OUTPUT @Agt4338b ; " *OPC?"
210 ENTER @Agt4338b ; Buff$
220 !
230 ! Triggering and data read
240 !
250 ON INTR 7 GOTO Meas_end
260 ENABLE INTR 7 ; 2
270 PRINT "Waiting for External Trigger!"
280 Meas_wait : GOTO Meas_wait
290 Meas_end : OFF INTR 7
300 OUTPUT @Agt4338b ; " : FETC?"
310 IF Comp_flag=1 THEN
320   ENTER @Agt4338b ; Meas_stat, Pri_para, Sec_para, Comp1, Comp2
330 ELSE
340   ENTER @Agt4338b ; Meas_stat, Pri_para, Sec_para
350 END IF
360 !
370 ! Display results
380 !
390 PRINT USING "15A, X, D" ; "Meas. status : ", Meas_stat
400 PRINT USING "15A, X, SD . 5DE" ; "Pri. parameter : ", Pri_para
410 PRINT USING "15A, X, SD . 5DE" ; "Sec . parameter : ", Sec_para
420 IF Comp_flag=1 THEN
430   PRINT USING "15A, X, K" ; "Primary Comparator : ", Comp1
440   PRINT USING "15A, X, K" ; "Secondary Comparator : ", Comp2
450 ELSE
460   PRINT USING "19A" ; "Comparator : OFF"
470 END IF
480 END

```

**Figure 4-6.**

**Reading out the measured result in ASCII transfer format using the :FETC? command**



The program of Figure 4-7 is detailed below.

Lines 50 to 60	Sets the GPIB address.
Line 70	Sets the data transfer format to the binary format.
Lines 90 to 100	Turns ON the trigger system continuous startup and sets the trigger mode to the external trigger.
Lines 120 to 130	Reads out the ON/OFF state of the comparator function and assigns it to the Comp_flag variable.
Lines 170 to 210	Makes the setup generate an SRQ when measurement finishes and clears the status byte register and operation status event register.
Lines 250 to 260	Sets the branch destination of the SRQ interrupt and enables the SRQ interrupt.
Lines 270 to 280	Displays the message to prompt the user to input an external trigger and then waits until the external trigger is inputted and the measurement finishes.
Line 300	Executes the measured result readout command (:FETC?).
Lines 310 to 340	Reads out the header part.
Line 360	If the Comp_flag value is 1 (the comparator function is ON), reads out the measurement status, measured primary parameter result, measured secondary parameter result, and comparator sorting result.

---

**Note** Binary data must be read out without formatting. Therefore, use an I/O path (@Binary) set up as such for readout. This is also applicable to Line 380.



---

Line 380	If the Comp_flag value is not 1 (the comparator function is OFF), reads out the measurement status, measured primary parameter result, and measured secondary parameter result.
Line 400	Reads out the message terminator at the end of the data.
Lines 440 to 460	Displays the measurement status, measured primary parameter result, and measured secondary parameter result.
Line 480 to 490	If the Comp_flag value is 1 (the comparator function is ON), displays the comparator sorting result.
Line 510	If the Comp_flag value is not 1 (the comparator function is OFF), displays "Comparator : OFF."

```

10 DIM Buff$ [9] , Digit$ [1] , Read_form$ [9] , Num_of_byte$ [9]
20 REAL Pri_para , Sec_para
30 REAL Meas_stat , Comp1 , Comp2
40 INTEGER Comp_flag
50 ASSIGN @Binary TO 717 ; FORMAT OFF
60 ASSIGN @Agt4338b TO 717
70 OUTPUT @Agt4338b ; " : FORM REAL"
80 !
90 OUTPUT @Agt4338b ; " : INIT:CONT ON"
100 OUTPUT @Agt4338b ; " : TRIG:SOUR EXT"
110 !
120 OUTPUT @Agt4338b ; " : CALC : LIM : STAT?"
130 ENTER @Agt4338b ; Comp_flag
140 !
150 ! SRQ setting
160 !
170 OUTPUT @Agt4338b ; " : STAT : OPER : ENAB 16"
180 OUTPUT @Agt4338b ; " *SRE 128"
190 OUTPUT @Agt4338b ; " *CLS"
200 OUTPUT @Agt4338b ; " *OPC?"
210 ENTER @Agt4338b ; Buff$
220 !
230 ! Triggering and data read
240 !
250 ON INTR 7 GOTO Meas_end
260 ENABLE INTR 7 ; 2
270 PRINT "Waiting for External Trigger!"
280 Meas_wait: GOTO Meas_wait
290 Meas_end: OFF INTR 7
300 OUTPUT @Agt4338b ; " : FETC?"
310 ENTER @Agt4338b USING "# , A" ; Buff$
320 ENTER @Agt4338b USING "# , A" ; Digit$
330 Read_form$="# , " &Digit$&"A"
340 ENTER @Agt4338b USING Read_form$ ; Num_of_byte$
350 IF Comp_flag=1 THEN
360     ENTER @Binary ; Meas_stat , Pri_para , Sec_para , Comp1 , Comp2
370 ELSE
380     ENTER @Binary ; Meas_stat , Pri_para , Sec_para
390 END IF
400 ENTER @Agt4338b USING "# , A" ; Buff$
410 !
420 ! Display results
430 !
440 PRINT USING "15A , X , D" ; "Meas . status : " , Meas_stat
450 PRINT USING "15A , X , SD . 5DE" ; "Pri . parameter : " , Pri_para
460 PRINT USING "15A , X , SD . 5DE" ; "Sec . parameter : " , Sec_para
470 IF Comp_flag=1 THEN
480     PRINT USING "15A , X , K" ; "Primary Comparator : " , Comp1
490     PRINT USING "15A , X , K" ; "Secondary Comparator : " , Comp2
500 ELSE
510     PRINT USING "19A" ; "Comparator : OFF"
520 END IF
530 END

```

Figure 4-7.

Reading out measured result in binary transfer format using :FETC? command

## To Retrieve Data Efficiently

The basic procedure to retrieve measurement is described in “To Trigger a Measurement”. This section describes how to retrieve the measurement data efficiently.

### To Use a Data Buffer

You can use the data buffer to temporarily store the results of several measurements and then later read out these results in batch.

The following commands use the data buffer function:

- :DATA?
- :DATA:POIN
- :DATA:FEED
- :DATA:FEED:CONT

For example,

```

:
OPTION BASE 1
DIM D(600)
:
OUTPUT 717;":TRIG:SOUR BUS"
!
OUTPUT 717;":DATA:POIN BUF1,200"
OUTPUT 717;":DATA:FEED BUF1,'CALC1'"
OUTPUT 717;":DATA:FEED:CONT BUF1,ALW"
!
FOR I=1 TO 200
  OUTPUT 717;":TRIG"
NEXT I
!
OUTPUT 717;":DATA? BUF1"
ENTER 717;D(*)
PRINT D(*)
:

```

## Other Features

### To test the 4338B

The following command performs the internal self test.

- \*TST?

For example,

```
OUTPUT 717;"*TST?"
ENTER 717;A
IF A<>0 THEN PRINT "Self Test: Error"
```

### To Report the Instrument's Status

The following commands report the instrument's status.

- \*CLS
- \*ESE
- \*ESR?
- \*SRE
- \*STB?
- :STAT:OPER?
- :STAT:OPER:COND?
- :STAT:OPER:ENAB
- :STAT:QUES?
- :STAT:QUES:COND?
- :STAT:QUES:ENAB
- :STAT:PRES
- HP BASIC SPOLL command

For example, to generate a service request whenever an error is placed in the error queue.

```
OUTPUT 717;"*ESE 52; *SRE 32"
```

For example, to detect the completion of the actual measurement,

```
OUTPUT 717;":SYST:OPER:ENAB 16"   Enable Measuring bit
OUTPUT 717;"*SRE 128"           Enable Operation Status Register Summary bit
REPEAT                           Wait until Operation Status Register Summary bit
  A=SPOLL(717)                   is set
UNTIL BIT(A,7)
```

For example, to generate an interrupt when an error occurs in the 4338B.

```

:
DIM Err$(50)
!
:
OUTPUT 717;"*CLS"           Clears status byte register
OUTPUT 717;"*ESE 48"       Sets Command Error Bit and Execution Error Bit
OUTPUT 717;"*SRE 32"       Sets Standard Event Status Register Summary Bit
!
ON INTR 7 GOSUB Err_report  Tells where to branch to when interrupted
ENABLE INTR 7;2             Enable an interrupt from GPIB interface
!
:
LOOP
:
END LOOP
STOP
!
Err_report:!
Stat=SPOLL(717)             Clears the SRQ bit of the Status Byte
OUTPUT 717;"*ESR?"         Asks contents of the Standard Event Status Register
ENTER 717;Estat
PRINT "Syntax Error detected."
!
OUTPUT 717;" :SYST:ERR?"    Asks to output error number and message
ENTER 717;Err,Err$
PRINT Err,Err$
!
ENABLE INTR 7
RETURN
END

```

## If You Have a Problem

Check all GPIB addresses and connections; most GPIB problems are caused by an incorrect address and bad or loose GPIB cables.

### If the 4338B Hangs Up When You Send ABORT Command

- Send the device clear command to the 4338B.

For example,

```
CLEAR(717)
```



## GPIB Reference

---

### Introduction

This chapter provides the reference for the GPIB commands used to control the 4338B in the GPIB remote mode.

- GPIB Commands
- Status Reporting Structure
- Trigger System
- Data Transfer Format

The 4338B can be operated using the General Purpose Interface Bus (GPIB). GPIB corresponds to the Standard Commands for Programmable Instruments (SCPI). SCPI is the instrument command language for controlling instrument that goes beyond IEEE 488.2 to address a wide variety of instrument functions in a standard manner.

---

### GPIB Commands

Commands can be separated into two groups: common commands and subsystem commands.

#### Common Commands

Common commands are generally not measurement related, but are used to manage macros, status registers, synchronization, and data storage. All common commands begin with an asterisk. Common commands are defined in the IEEE 488.2 standard.

#### Common Commands

*CLS		*OPC		*SRE	<numeric_value>
*ESE	<numeric_value>	*OPC?		*SRE?	
*ESE?		*OPT?		*STB?	
*ESR?		*RCL	<numeric_value>	*TRG	
*IDN?		*RST		*TST?	
*LRN?		*SAV	<numeric_value>	*WAI	

#### Subsystem Commands

Subsystem commands include all measurement functions and some general purpose functions. Each subsystem is a set of commands that roughly corresponds to a functional block inside the instrument. For example, the SOURce subsystem contains commands for signal generation, while the STATus subsystem contains commands for accessing status registers.

Subsystem commands have a hierarchical structure, called a **command tree**, which consist of several key words separated by a colon between each word.



Subsystem Commands

Command	Parameter	Note
ABORt		no query
CALCulate{1 2}		
:FORMat	{REAL MLINear NONE IMAGinary PHASe LS}	
:LIMit		
:BEEPer		
:CONDition	{FAIL   PASS}	
[:STATe]	< Boolean >	
:CLEAr		no query
:FAIL?		query only
:LOWer		
[:DATA]	< numeric_value >	
:STATe	< Boolean >	
:STATe	< Boolean >	
:UPPer		
[:DATA]	< numeric_value >	
:STATe	< Boolean >	
:MATH		
:EXPRession		
:CATalog?		query only
:NAME	{DEV PCNT}	
:STATe	< Boolean >	
:PATH?		query only
DATA		
[:DATA]	{REF1 REF2}, < numeric_value >	
[:DATA]?	{BUF1 BUF2}	query only
:FEED	{BUF1 BUF2}, < data_handle >	
:CONTRol	{BUF1 BUF2}, {ALWays NEVer}	
:POINts	{BUF1 BUF2}, < numeric_value >	
DISPlay		
[:WINDow]		
[:STATe]	< Boolean >	
:TEXT1		
:DIGit	{3 4 5}	
:PAGE	{1 2}	
:TEXT2		
:PAGE	{1 2 3 4}	
FETCh?		query only
FORMat		
[:DATA]	{ASCIi REAL[,64]}	
INITiate		
:CONTInuous	< Boolean >	
[:IMMediate]		no query
[SENSe]		
:AVERage		
:COUNT	< numeric_value >	
[:STATe]	< Boolean >	

## Subsystem Commands (continued)

Command	Parameter	Note
[SENSe] (continued)		
:CORRection		
:COLLect		
[:ACQuire]	STANdard2	
:METhod	REFL1	
:DATA?	STANdard2	
[:STATe]	<Boolean>	
:FIMPedance		
:APERture	<numeric_value>[MS S]	
:CONtact		
:VERify	<Boolean>	
:RANGe		
:AUTO	<Boolean>	
[:UPPer]	<numeric_value>[MOHM OHM KOHM]	
:FUNCTion	<sensor_function>	
SOURce		
:CURRent		
[:LEVel]		
[:IMMediate]		
[:AMPLitude]	<numeric_value>[UA MA]	
:AUTO	<Boolean>	
STATus		
:OPERation		
:CONDition?		query only
:ENABle	<numeric_value>	
[:EVENT]?		query only
:PRESet		no query
:QUEStionable		
:CONDition?		query only
:ENABle	<numeric_value>	
[:EVENT]?		query only
SYSTem		
:BEEPer		
[:IMMediate]		no query
:STATe	<Boolean>	
:ERRor?		query only
:KLOCK	<Boolean>	
:LFRequency	<numeric_value>	
:PRESet		
:VERSion?		query only
TRIGger		
[:SEQuence1]		
:DELay	<numeric_value>[MS S]	
[:IMMediate]		no query
:SOURce	{BUS EXtErnal INtErnal MANual}	
:SEQuence2		
:DELay	<numeric_value>[MS S]	

## Subsystem Command Tree

Top of the subsystem command tree is called the **root command**, or simply the **root**. To reach the low-level commands, you must specify a particular **path** just like you would for example specify a DOS file directory path. After Power ON or after \*RST, the current path is set to the root. The path settings are changed as follows:

**Message Terminator** A message terminator, such as <new line> character, sets the current path to the root.

**Colon (:)** When a colon is placed between two command mnemonics, the colon moves the current path down one level on the command tree. When the colon is the first character of a command, it specifies the following command mnemonic is a root-level command.

**Semicolon (;)** A semicolon separates two commands in the same message without changing the current path.

Common commands, such as \*RST, are not part of any subsystem. The 4338B interprets them in the same way, regardless of the current path setting.

Figure 5-1 shows examples of how to use the colon and semicolon to navigate efficiently through the command tree.

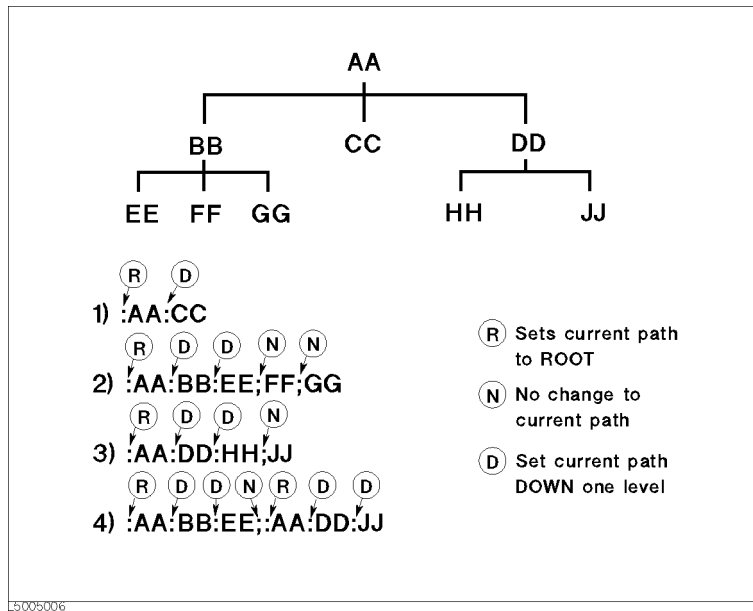

Figure 5-1. Proper Use of the Colon and Semicolon

In Figure 5-1, notice how proper use of the semicolon can save typing. Sending this message:

```
:AA:BB:EE; FF; GG
```

Is the same as sending these three messages:

```
:AA:BB:EE
:AA:BB:FF
:AA:BB:GG
```

## Program Message Syntax

This section provides an example of constructing a SCPI program message. A program message is the message sent from a computer to an instrument. Program messages consist of commands combined with appropriate punctuation and program message terminators.

### Case

Letter case (upper and lower) is ignored.

### Program Message Terminator

A program message must end with one of the three **program message terminators**, <new line>, <^END>, or <new line><^END>. <^END> means that EOI is asserted on the GPIB interface at the same time the preceding data byte is sent. For example, HP BASIC OUTPUT statement automatically sends a message terminator after the last data byte is sent. If you are using a PC, you can usually configure your system to send whatever terminator you specify.

### Subsystem Command Syntax

Subsystem command consists of the level mnemonics which are separated with colons. For example, command form of APERTure under [SENSe]:FIMPedance subsystem becomes as follows:

```
:FIMPedance:APERture
```

Abbreviated mnemonics are also available for command headers. In the above example, :FIMP:APER is available.

### Common Command Syntax

Common commands do not have a hierarchical structure. They are just sent as follows:

```
*CLS
```

### Parameters

There must be a <space> between the last command mnemonic and the first parameter in a subsystem command.

```
:FIMP:APER␣parameter
```

␣ means a space (ASCII character (decimal 32)) is inserted here.

If you send more than one parameter with a single command, each parameter must be separated by a comma. For example, :POINts command of DATA subsystem is followed by two parameters as follows:

```
:DATA:POIN␣parameter,parameter
```

### Parameter Types

SCPI defines different data formats for use in program messages and query responses. The 4338B accepts commands and parameters in various formats and responses a particular query in a predefined and rigid format. Each command reference contains information about available parameter types for the individual commands.

- <numeric\_value> is used in both common commands and subsystem commands.  
<numeric\_value> represents numeric parameter as follows:

- 100 no decimal point required
- 100. fractional digits optional
- 1.23, +235 leading signs allowed
- 4.56eL3 space allowed after e in exponential
- 7.89E-01 use either E or e in exponential
- .5 digits left of decimal point optional

The 4338B setting programmed with a numeric parameter can assume a finite number of values, so the 4338B automatically rounds off the parameter. For example, the 4338B has programmable line frequencies of 50 or 60 Hz. If you specified 50.1, it would be rounded off to 50.

The subsystem commands can use extended numeric parameters. Extended numeric parameters accept all numeric parameter values and other special values, for instance, MAXimum, MINimum or UP, DOWN. The special values available for a command are described in the each command's reference description.

Query response to *<numeric\_value>* is always a numeric value.

- *<Boolean>* represents a single binary condition that is either ON or OFF. *<Boolean>* allows the following parameters:

- ON, OFF In a program message
- 1, 0 In a program message and query response

- *<sensor\_function>* and *<data\_handle>* are string parameters which contain ASCII characters. A string must begin with a single quote(ASCII 39 decimal) or a double quote (ASCII 34 decimal) and end with the same character. The quote to mark the beginning and end of the string is called the delimiter. You can include the delimiter as part of the string by typing it twice without any characters in between.

Example of *<sensor\_function>* "FIMPedance",

```
10 OUTPUT @Meter;":FUNC 'FIMP'" using single quote
20 OUTPUT @Meter;":FUNC ""FIMP"" using double quote
```

Query response is the string between the double quote delimiters.

**Suffix**

When a command has a specified suffix, the suffix multiplier and suffix units (The suffix multiplier must be used with the suffix unit.) can be used with parameters as follows:

**Table 5-1. Suffix Multiplier**

Definition	Mnemonic	Available Suffix
10 <sup>3</sup> (Kilo)	K	A OHM S
10 <sup>-3</sup> (Milli)	M	
10 <sup>-6</sup> (Micro)	U	

For example,

```
10 OUTPUT @Meter;":TRIG:DEL 30MS" 30MS is a parameter which means 30 ms
```

The suffix is optional and can be omitted. The suffixes available for the commands are described in the reference for each command.

## Multiple Messages

To send more than one command in the same message, you must separate the commands with a semicolon:

```
*CLS; :INIT
```

## Query and Response Message Syntax

All subsystem commands can be queried except for the commands described as “no query” in the command reference. To send a query message, add ? after last command mnemonic.

```
:FIMP:APER?
```

A response message may contain both commas and semicolons as separators. When a single query command returns multiple values, a comma is used to separate each data item. When multiple queries are sent in the same message, the group of data items corresponding to each query are separated by a semicolon. For example, the fictitious query :QUERY1?;QUERY2? might return a response message of:

```
<data1>,<data1>;<data2>,<data2>
```

After the message, <new line><^END> is always sent as a response message terminator.

---

## Command Reference

In this section, all the commands which are available with the 4338B are listed in alphabetical order.

### Notations

The following conventions and definitions are used in this chapter to describe GPIB operation.

**:CALClate{1|2};LIMit;LOWer[:DATA] <numeric\_value>**

Sets or queries the lower limit of the specified parameter.

**:CALClate{1|2};LIMit;LOWer:STATe{ON|OFF|1|0}**

Sets or queries if the lower limit of the specified parameter is enabled.

< > Angular brackets enclose words or characters that are used to symbolize a program code parameter or an GPIB command.

[ ] Square brackets indicates that the enclosed items are optional.

{ } When several items are enclosed by braces, one and only one of these elements may be selected.

| A vertical bar is read as “or” and is used to separate alternative parameter options.

for example,

**:CALClate{1|2}** means **:CALC1** or **:CALC2**.

**[:DATA]** is optional, so this allows to omit the keyword, for example

**:CALC1;LIM:LOW <numeric\_value>**

---

## ABORt Command

### :ABORt

The ABORt command resets the trigger system and places all trigger sequences in the IDLE state. Any actions related the trigger system that are in progress, such as acquiring a measurement, are aborted immediately. The execution of an ABORt command will set any the pending operation flags to false, for example flags that were set by the initiation of the trigger system. See “Trigger System”.

Unlike \*RST, ABORt does not alter the settings programmed by other commands. (No query)

---

#### Note



After FETCh? query, \*TRG command, or the BASIC command TRIGGER, the ABORt command will cause the GPIB bus to hang up. To avoid this, before ABORt command execution, clear the GPIB bus by executing the BASIC command CLEAR (*address*).

---



## CALCulate Subsystem

The CALCulate subsystem controls the following measurement-data processing procedures:

1. to select the measurement parameter (CALClate:FORMat subsystem)
2. to control the deviation measurement mode (CALCulate:MATH subsystem)
3. to control the comparator function (CALClate:LIMit subsystem)

The 4338B performs data processing in the order listed.

The CALCulate subsystem is logically between the SENSE subsystem and data output to either the bus or the display, and is used with the SENSE subsystem, the DATA subsystem and FETCh? query.

COMMAND	PARAMETER
CALCulate{1 2}	
:FORMat	{REAL MLINear NONE IMAGinary PHASe LS}
:LIMit	
:BEEPper	
:CONDition	{FAIL   PASS}
[:STATe]	<Boolean>
:CLEar	
:FAIL?	
:LOWer	
[:DATA]	<numeric_value>
:STATe	<Boolean>
:STATe	<Boolean>
:UPPer	
[:DATA]	<numeric_value>
:STATe	<Boolean>
:MATH	
:EXPRession	
:CATalog?	
:NAME	{DEV PCNT}
:STATe	<Boolean>
:PATH?	

**:CALCulate1:FORMat { REAL | MLINear }**  
**:CALCulate2:FORMat { NONE | IMAGinary | PHASe | LS }**

Sets or queries the measurement parameter. For information on selecting measurement parameters, refer to Table 5-2.

This command works with the SENSE subsystem. The 4338B measures the DUT's vector impedance value, using the method specified by the SENSE subsystem. After the measurement, the scalar measurement parameter is calculated from the vector value, as specified by the CALCulate{1|2}:FORMat command.

The selection decides the measurement parameter displayed by the 4338B and also the data processed by CALCulate:LIMit, CALCulate:MATH or DATA subsystem commands.

CALCulate1 selects the primary parameter.

CALCulate2 selects the secondary parameter.

REAL	real part of impedance
IMAGinary	imaginary part of impedance
MLINear	absolute value of impedance
PHASe	phase of impedance
LS	equivalent series inductance
NONE	none

**Note** You cannot set CALC1:FORM and CALC2:FORM to combinations not specified in Table 5-2.



**Table 5-2. Measurement Parameter Selection**

Parameters	CALC1:FORM	CALC2:FORM
R	REAL	NONE
R-L	REAL	LS
R-X	REAL	IMAGinary
Z-∠	MLINear	PHASe

**:CALCulate{1|2}:LIMit:BEEPer:CONDition { FAIL | PASS }**

Defines comparator output to the beeper.

CALCulate1 selects the primary parameter.

CALCulate2 selects the secondary parameter.

FAIL emits a beep when the comparison result is FAIL (High or Low).

PASS emits a beep when the comparison result is PASS (In).

This command is effective when SYSTem:BEEPer:STATe command is set to 0N and CALCulate{1|2}:LIMit:BEEPer:STATe command is set to 0N.

Query response is {FAIL|PASS}.

**Note** The comparator output states of both parameters are linked together. So the CALCulate{1|2}:LIMit:BEEPer command toggles the comparator function of both parameters PASS or FAIL.



**:CALCulate{1|2}:LIMIT:BEEPer[:STATe] { ON | OFF | 1 | 0 }**

Sets or queries if the comparator output to the beeper is enabled.

ON, 1 enables comparator output to the beeper as defined by  
CALCulate{1|2}:LIMIT:BEEPer:CONDition command.  
OFF, 0 disables comparator output to the beeper.

When you enable the beeper function, the SYSTem:BEEPer:STATe command is automatically set to ON.

Query response is {1|0}.

**Note**

The comparator output states of both parameters is linked together. So the CALCulate{1|2}:LIMIT:BEEPer command toggles the comparator function of both parameters ON or OFF.

**:CALCulate{1|2}:LIMIT:CLEAr**

Clears the data which is reported by CALCulate{1|2}:LIMIT:FAIL? command. (no query)

CALCulate1 selects the primary parameter.  
CALCulate2 selects the secondary parameter.

**:CALCulate{1|2}:LIMIT:FAIL?**

Returns the comparison result of the selected parameter. (query only)

CALCulate1 selects the primary parameter.  
CALCulate2 selects the secondary parameter.

Query response is {1|0}. Where,

1 comparison result is FAIL.  
0 comparison result is PASS.

**:CALCulate{1|2}:LIMIT:LOWer[:DATA] <numeric\_value>**

Sets or queries the lower limit value of the selected channel.

CALCulate1 selects the primary parameter.  
CALCulate2 selects the secondary parameter.

<numeric\_value> is,

*numeric*  $-9.999 \times 10^{14}$  to  $9.999 \times 10^{14}$   
MAXimum  $9.999 \times 10^{14}$   
MINimum  $-9.999 \times 10^{14}$

Query response is <numeric\_value>, in <NR3> format.

**:CALCulate{1|2}:LIMIT:LOWER:STATE { ON | OFF | 1 | 0 }**

Sets or queries if the lower limit of selected channel is enabled.

CALCulate1 selects the primary parameter.  
CALCulate2 selects the secondary parameter.

ON, 1 enables the lower limit.

OFF, 0 disables the lower limit.

Query response is {1|0}.

**:CALCulate{1|2}:LIMIT:STATE { ON | OFF | 1 | 0 }**

Sets or queries if the comparator function is enabled.

CALCulate1 selects the primary parameter.  
CALCulate2 selects the secondary parameter.

ON, 1 enables the upper limit.

OFF, 0 disables the upper limit.

Query response is {1|0}.

**:CALCulate{1|2}:LIMIT:UPPER[:DATA] <numeric\_value>**

Sets or queries the upper limit value of the selected parameter.

CALCulate1 selects the primary parameter.  
CALCulate2 selects the secondary parameter.

<numeric\_value> is,

*numeric*  $-9.999 \times 10^{14}$  to  $9.999 \times 10^{14}$

MAXimum  $9.999 \times 10^{14}$

MINimum  $-9.999 \times 10^{14}$

**:CALCulate{1|2}:LIMIT:UPPER:STATE { ON | OFF | 1 | 0 }**

Sets or queries if the upper limit of the selected parameter is enabled.

CALCulate1 selects the primary parameter.  
CALCulate2 selects the secondary parameter.

ON, 1 sets the comparator function ON.

OFF, 0 sets the comparator function OFF.

Query response is {1|0}.

**:CALCulate{1|2}:MATH:EXPRESSION:CATalog?**

Returns available parameters which are used with CALCulate{1|2}:MATH:EXPRESSION:NAME command. (query only)

For more information, see CALCulate{1|2}:MATH:EXPRESSION:NAME command.

Query response is DEV,PCNT.

**:CALCulate{1|2}:MATH:EXPRession:NAME { DEV | PCNT }**

Defines or queries the expression used for math processing, which is enabled by CALCulate{1|2}:MATH:STATe. The 4338B has deviation measurement capability which generates an output of the deviation between measurement result and a user-defined nominal value. The nominal value can be defined using the DATA[:DATA] command.

CALCulate1                selects the primary parameter.  
 CALCulate2                selects the secondary parameter.  
 DEV                        absolute value of deviation  
 PCNT                        percentage of deviation

At \*RST, :CALCulate{1|2}:MATH:EXPRession:NAME is set to DEV.

**:CALCulate{1|2}:MATH:STATe { ON | OFF | 1 | 0 }**

Sets or queries if math processing defined by :CALCulate{1|2}:MATH:EXPRession:NAME is enabled.

ON, 1                      enables math processing.  
 OFF, 0                     disables math processing.

Query response is {1|0}.

**:CALCulate{1|2}:PATH?**

Returns the CALCulate subsystems in the order in which they are to be performed. (query only)

CALCulate1                selects the primary parameter.  
 CALCulate2                selects the secondary parameter.

Query response is FORM,MATH,LIM.

## DATA Subsystem

The DATA subsystem commands are used to store and read measurement data to and from the 4338B's data buffer. The 4338B provides four data buffers which are named BUF1, BUF2, REF1, and REF2.

BUF1 and BUF2 are used to store measurement results, and up to 200 measurements can be stored into each buffer. Into REF1 and REF2, the reference values for deviation measurement are entered. REF1 is for the primary parameter, and REF2 for the secondary parameter. REF1 and REF2 can store only one data, which is the nominal value for the deviation measurement. The data stored in the BUF1 and BUF2 are set by :DATA:FEED { BUF1 | BUF2 },<data\_handle> command.

COMMAND	PARAMETER
DATA	
[:DATA]	{REF1 REF2},<numeric_value>
[:DATA]?	{BUF1 BUF2}
:FEED	{BUF1 BUF2},<data_handle>
:CONTRol	{BUF1 BUF2},{ALWays NEVer}
:POINTs	{BUF1 BUF2},<numeric_value>

**:DATA[:DATA] { REF1 | REF2 },<numeric\_value>**

Enters the data into the data buffer, REF1 or REF2.

The 4338B has capability of deviation measurement which generates output of deviation between measurement result and user-defined nominal value. The DATA[:DATA] command allows programmer to define the nominal value. Deviation measurement is controlled by the CALCulate{1|2}:MATH command.

REF1            nominal value for primary parameter data processing  
REF2            nominal value for secondary parameter data processing

Query response of DATA[:DATA]? { REF1 | REF2 } retrieves the data buffer, REF1 or REF2, according to the format determined by FORMat subsystem commands.

**:DATA[:DATA]? { BUF1 | BUF2 }**

Returns the data held in the data buffer, BUF1 or BUF2, according to the format determined by FORMat subsystem commands. (query only)

This query needs the parameter {BUF1|BUF2}, which is the name of the data buffer to be read. So, the query form is :DATA[:DATA]? BUF1 or :DATA[:DATA]? BUF2.

Reading the data buffer returns its pointer to the head of the buffer. After that, data will be stored starting from the head of the buffer.

Query response is,

<set1>,<set2>, ... <setn>

Where,

<set1> : data set of the first measured point

<set2> : data set of the second measured point

⋮

<setn> : data set of the last measured point (*n* is specified by DATA:POINts command)

Every data set contains the following data: <stat>,<data>,<comp>

Where,

<stat> measured status

0 : normal

1 : overload

2 : no contact

4 : over-voltage

<data> measured data

<comp> comparison result

0 : OFF

1 : In

2 : High

4 : Low

8 : no contact

**:DATA:FEED { BUF1 | BUF2 },<data\_handle>**

Sets or queries whether or not measurement data is fed into data buffer.

:DATA:FEED? query requires the parameter, BUF1 or BUF2, which is the name of the data buffer. So, the query form is :DATA:FEED? BUF1 or :DATA:FEED? BUF2.

<data\_handle> is,

"CALCulate1" set to feed data specified CALCulate1:MATH command.

"CALCulate2" set to feed data specified CALCulate2:MATH command.

""(null string) set to feed nothing into data buffer

At \*RST, :DATA:FEED { BUF1 | BUF2 } is set to "".

Query response is,

{ "CALC1" | "CALC2" | "" }.

**:DATA:FEED:CONTRol { BUF1 | BUF2 }, { ALWays | NEVer }**

Sets or queries whether or not measurement data is fed into the data buffer. The data fed to the data buffer using this command is specified by :DATA:FEED { BUF1 | BUF2 } command. This control has no effect if :DATA:FEED { BUF1 | BUF2 } is set to NONE.

ALWays            feed data into data buffer, whenever new data available  
NEVer             no data is in the buffer.

At \*RST, :DATA:FEED:CONTRol { BUF1 | BUF2 } is set to NEVer.

Query response is { ALW | NEV }.

**:DATA:POINts { BUF1 | BUF2 }, <numeric\_value>**

Sets or queries the size of a data buffer. The amount of measurement data that can be stored into the data buffer is defined using this command.

This command returns data buffer pointer to the head of the buffer. After that, data will be stored from the head of the buffer.

:DATA:POINts? query must have the parameter, BUF1 or BUF2, which is the name of the data buffer. So, the query form is :DATA:POINts? BUF1, or :DATA:POINts? BUF2.

<numeric\_value> is,

*numeric*            1 to 200

Query response is <numeric\_value>.



## DISPlay Subsystem

The DISPlay subsystem controls the selection of the display mode.

COMMAND	PARAMETER
DISPlay	
:WINDow	
[:STATe]	<Boolean>
:TEXT1	
:DIGit	{3 4 5}
:PAGE	{1 2}
:TEXT2	
:PAGE	{1 2 3 4}

### **:DISPlay[:WINDow][:STATe] { ON | OFF | 1 | 0 }**

Sets or queries whether the display is ON or OFF.

ON, 1                   sets the display to be visible.  
OFF, 0                  sets the display to be blank.

Query response is {1|0}.

### **:DISPlay[:WINDow]:TEXT1:DIGit { 3|4|5 }**

Selects the display digits.

3                    3 digits  
4                    4 digits  
5                    5 digits

Query response is {3|4|5}

### **:DISPlay[:WINDow]:TEXT1:PAGE { 1 | 2 }**

Sets or queries the display mode.

1                    displays the measurement results.  
2                    displays the comparison results.

Query response is {1|2}.

### **:DISPlay[:WINDow]:TEXT2:PAGE { 1|2|3|4 }**

Selects the mode of Measurement Settings Display.

1                    displays the test signal level and averaging rate.  
2                    displays the trigger delay and source delay.  
3                    displays the comparator limits of primary parameter.  
4                    displays the comparator limits of secondary parameter.

Query response is {1|2|3|4}.

---

## FETCh? Query

### :FETCh?

The FETCh? query retrieves the measurements taken by the INITiate command and places them into the 4338B's output buffer. (Query only)

Query response is

```
<stat>,<data1>,<data2>,<comp1>,<comp2>
```

Where,

- <stat> measured status
  - 0 : normal
  - 1 : overload
  - 2 : no contact
  - 4 : over-voltage
- <data1> measurement data of primary parameter
- <data2> measurement data of secondary parameter  
(Meaningless output when the secondary parameter is none)
- <comp1> comparison result of the primary parameter  
(No output when comparator is OFF)
  - 1 : In
  - 2 : High
  - 4 : Low
  - 8 : no contact
- <comp2> comparison result of the secondary parameter  
(No output when comparator is OFF)  
(Meaningless output when the secondary parameter is none)
  - 1 : In
  - 2 : High
  - 4 : Low
  - 8 : no contact

Data format is specified using the FORMat subsystem.

For more information, refer to "To Trigger a Measurement" in Chapter 4.

---

## FORMat Subsystem

COMMAND	PARAMETER
FORMat [:DATA]	{ ASCii REAL[,64]}

### **:FORMat[:DATA] { ASCii | REAL[,64] }**

Sets the data format for transferring numeric and array information retrieved using the DATA subsystem or the FETCh? query.

ASCii sets the data transfer format to the ASCII transfer format.

REAL [,64] sets the data transfer format to the real 64-bit transfer format.

For details about the data transfer formats, see “Data Transfer Format”.

Query response is {ASC|REAL,64}.

## INITiate Subsystem

The INITiate subsystem controls the initiation of the trigger system. It indicates all trigger sequences as a group. The detailed description of the trigger system is in “Trigger System”.

COMMAND	PARAMETER
INITiate	
:CONTinuous	<Boolean>
[:IMMediate]	

### :INITiate[:IMMediate]

The :INITiate[:IMMediate] command causes all sequences to exit the IDLE state and enter the INITIATE state. This command causes the trigger system to initiate and complete one full trigger cycle, returning to IDLE on completion. If the 4338B is not in IDLE or if INITiate:CONTinuous is set to ON, an :INITiate:IMMediate command has no effect on the trigger system and error –213 is generated. (No query)

### :INITiate:CONTinuous { ON | OFF | 1 | 0 }

The INITiate:CONTinuous command sets or queries whether or not the trigger system is being continuously initiated.

ON, 1           continuously initiated.  
OFF, 0          not continuously initiated.

Query response is {1|0}.

## SENSe Subsystem

COMMAND	PARAMETER
[SENSe]	
:AVERage	
:COUNT	<numeric_value>
[:STATe]	<Boolean>
:CORRection	
:COLLect	
[:ACQuire]	STANdard2
:METHod	REFL1
:DATA?	STANdard2
[:STATe]	<Boolean>
:FIMPedance	
:APERture	<numeric_value>[MS S]
:CONtact	
:VERify	<Boolean>
:RANGe	
:AUTO	
[:UPPer]	<numeric_value>[MOHM OHM KOHM]
:FUNcTION	<sensor_function>

### **[[:SENSe]:AVERage:COUNT <numeric\_value>**

Sets or queries the averaging rate.

<numeric\_value> is,

<i>numeric</i>	1 to 256 (integer), default is 1
MAXimum	256
MINimum	1

Query response is <numeric\_value>, <NR1> format.

### **[[:SENSe]:AVERage[:STATe] { ON | OFF | 1 | 0 }**

Sets or queries if averaging is enabled.

ON, 1	enables averaging.
OFF, 0	disables averaging.

Query response is {1|0}.

### **[[:SENSe]:CORRection:COLLect[:ACQuire] STANdard2**

Performs a SHORT correction. The instrument takes SHORT correction data which cancels measurement errors due to the residual impedance of the cable and test fixture.(no query)

The SHORT correction must be performed with the high and low terminals shorted together directly or using a low impedance shorting device.

This command sets [SENSe:]CORRection[:STATe] ON, which enables the correction function.

---

**Note** 2 of STANdard2 cannot be omitted. The short form must be STAN2.



---

### **[[:SENSe]:CORRection:COLLect:METhod REFL1**

Selects or queries available correction data. Actually the 4338B can take only SHORT correction data, so [[:SENSe]:CORRection:COLLect:METhod is always set to REFL1.

REFL1 selects the SHORT correction.

### **[[:SENSe]:CORRection:DATA? STANdard2**

Queries the short correction data (R-X).

Example:

```
OUTPUT 717;"CORRection:DATA? STAN2"
ENTER 717;R,X
```

---

**Note** When "WARNING : Improper Correction" is displayed, 99.999TΩ are set at R, X values.



---

**Note** 2 of STANdard2 cannot be omitted. The short form must be STAN2



---

### **[[:SENSe]:CORRection[:STATe] { ON | OFF | 1 | 0 }**

Sets or queries if the SHORT correction data taken by [[:SENSe]:CORRection:COLLect[:ACQuire] STANdard2 is enabled.

ON, 1 enables the SHORT correction data.  
OFF, 0 disables the SHORT correction data.

Query response is {1|0}.

---

**Note** The SHORT correction can be set to ON or OFF only by using GPIB commands and cannot be set by using front panel key input.



---

### **[[:SENSe]:FIMPedance:APERture <numeric\_value>[MS|S]**

Sets or queries measurement time to Short (=0.035 s), Medium (=0.07 s) or Long (=0.900 s).

<numeric\_value> is,

*numeric* 0.0035, 0.07 or 0.900 (s)

The following suffixes can be used with <numeric\_value>.

S : s                      MS : ms

Query response is  $\langle \text{numeric\_value} \rangle$ ,  $\langle \text{NR2} \rangle$  format.

### **[[:SENSe]:FIMPedance:CONtact:VERify {ON|OFF|1|0}**

Sets or queries if the contact check function is enabled. The contact check function monitors if the DUT is properly connected to the test electrodes.

ON, 1                enables contact check.  
OFF, 0              disables contact check.

Query response is {1|0}.  
Default setting is OFF.

### **[[:SENSe]:FIMPedance:RANGe:AUTO { ON | OFF | 1 | 0 }**

Sets or queries if the Auto range mode is enabled. In this mode the 4338B automatically selects the optimum measurement range.

ON, 1                The Auto mode is ON  
OFF, 0              The Auto mode OFF and the measurement range is in the Hold mode.

Query response is {1|0}.

### **[[:SENSe]:FIMPedance:RANGe[:UPPer] $\langle \text{numeric\_value} \rangle$ [MOHM|OHM|KOHM]**

Sets or queries the measurement range. Available measurement ranges are 1 m $\Omega$ , 10 m $\Omega$ , 100 m $\Omega$ , 1  $\Omega$ , 10  $\Omega$ , 100  $\Omega$ , 1 k $\Omega$ , and 10 k $\Omega$ , which are limited by the test level setting. (See Figure 3-2)

$\langle \text{numeric\_value} \rangle$  is,

<i>numeric</i>	$1.0 \times 10^{-3}$ , $1.0 \times 10^{-2}$ , $1.0 \times 10^{-1}$ , 1.0, $1.0 \times 10$ , $1.0 \times 10^2$ , $1.0 \times 10^3$ , $1.0 \times 10^4$ ( $\Omega$ )
MAXimum	10 k $\Omega$
MINimum	1 m $\Omega$
UP	move to upper range
DOWN	move to lower range

Following suffixes can be used with  $\langle \text{numeric\_value} \rangle$ .

MOHM : m $\Omega$             OHM :  $\Omega$             KOHM :k $\Omega$

### **[[:SENSe]:FUNctioN $\langle \text{sensor\_function} \rangle$**

Sets the measurement function to impedance measurement. The 4338B measures the vector impedance of the DUT and then uses the vector impedance to calculate the other measurement parameters. You can select the measurement parameter using CALCulate{1|2}:FORMat command.

<i>sensor_function</i>	measurement function
"FIMPedance"	impedance

[[:SENSe]:FUNctioN is always set to "FIMPedance", which is only  $\langle \text{sensor\_function} \rangle$  of the 4338B.

Query response is "FIMP".

---

**SOURCE Subsystem**

COMMAND	PARAMETER
SOURCE	
:CURRENT	
[:LEVEL]	
[:IMMEDIATE]	
[:AMPLITUDE]	<numeric_value>[UA MA]
:AUTO	<Boolean>

**:SOURCE:CURRENT[:LEVEL][:IMMEDIATE][:AMPLITUDE]**

<numeric\_value>[UA|MA]

Entries or queries the test level. The available test signal levels are 1  $\mu$ Arms, 10  $\mu$ Arms, 100  $\mu$ Arms, 1 mArms, and 10 mArms, while each test signal level limits the measurement range as shown in Figure 3-2.

<numeric\_value> is,

<i>numeric</i>	1.0 $\times$ 10 <sup>-6</sup> , 1.0 $\times$ 10 <sup>-5</sup> , 1.0 $\times$ 10 <sup>-4</sup> , 1.0 $\times$ 10 <sup>-3</sup> and 1.0 $\times$ 10 <sup>-2</sup> ( Arms )
MAXimum	10 mArms
MINimum	1 $\mu$ Arms

The following suffixes can be used with <numeric\_value>.

UA :  $\mu$ A            MA : mA

Query response is <numeric\_value>.

---

**Note**

The peak voltage across the DUT must be always less than 20 mV. When the peak voltage across the DUT exceeds 20 mV, the source output level is reduced to 0 V, and the 4338B displays "OVV0L" (Over Voltage). For details, see "Dry Circuit Loop" in Chapter 7.

---

**:SOURCE:CURRENT[:LEVEL][:IMMEDIATE][:AMPLITUDE]:AUTO { ON | OFF | 1 | 0 }**

Sets or queries if the auto level function is enabled.

ON, 1	Auto level is ON
OFF, 0	Auto level is OFF

Query response is {1|0}.



---

## STATus Subsystem

The STATus subsystem commands controls the OPERation and QUEStionable registers in the status-reporting structures(See “Status Reporting Structure”).

COMMAND	PARAMETER
STATus	
:OPERation	
:CONDition?	
:ENABle	<numeric_value>
[:EVENT]?	
:PRESet	
:QUEStionable	
:CONDition?	
:ENABle	<numeric_value>
[:EVENT]?	

### :STATus:OPERation[:EVENT]?

Returns the contents of the event register of the standard operation status group. (Query only)

Query response is a decimal expression of the contents of the register, in <NR1> format.

---

**Note**            Reading the event register clears it, this is a destructive read.



### :STATus:OPERation:CONDition?

Returns the contents of the condition register of the standard operation status group. (Query only)

Query response is a decimal expression of the contents of the register, in <NR1> format.

---

**Note**            Reading the condition register is nondestructive, the contents of the register are still contained in the register after the register is read.



### :STATus:OPERation:ENABle <numeric\_value>

Sets the enable register of the standard operation status group.

<numeric\_value> is,

*numeric*            decimal expression of the contents of the register, in <NR1> format.

Query response is a decimal expression of the contents of the register, in <NR1> format.

**:STATus:PRESet**

Clears the OPERation and QUEStionable register groups. Both the event and enable registers are cleared. (no query)

**:STATus:QUEStionable[:EVENT]?**

Returns the contents of the event register of the standard questionable status group. (query only)

Query response is a decimal expression of the contents of the register, in <NR1> format.

The 4338B has no operation to report the event to the questionable status event register, all of whose bits are always 0.

**:STATus:QUEStionable:CONDition?**

Returns the contents of the condition register of the standard questionable status group. (Query only)

Query response is a decimal expression of the contents of the register, in <NR1> format.

The 4338B has no operation to report the event to the questionable status condition register, all of whose bits are always set to 0.

**:STATus:QUEStionable:ENABle <numeric\_value>**

Sets or queries the enable register of the standard questionable status group.

<numeric\_value> is,

*numeric*                    decimal expression of the contents of the register

Query response is a decimal expression of the contents of the register, in <NR1> format.

## SYSTem Subsystem

The SYSTem subsystem reports the firmware version and errors, sets the beeper, locks the front-panel keys, and defines the line frequency.

COMMAND	PARAMETER
SYSTem	
:BEEPer	
[:IMMediate]	
:STATe	<Boolean>
:ERRor?	
:KLOCK	<Boolean>
:LFRequency	<numeric_value>
:PRESet	
:VERSion?	

### :SYSTem:BEEPer[:IMMediate]

Emits a beep. (no query)

### :SYSTem:BEEPer:STATe { ON | OFF | 1 | 0 }

Sets or queries if the beeper is enabled.

ON, 1 enables the beeper, and set beeper mode as defined by  
CALCulate{1|2}:LIMit:BEEPer command.

OFF, 0 disables the all beeper, including the error beep.

Query response is {1|0}.

### :SYSTem:ERRor?

Returns the existing error numbers and messages in the 4338B's error queue. (Query only)

### :SYSTem:KLOCK { ON | OFF | 1 | 0 }

Sets or queries whether or not the front-panel keys of the 4338B are locked.

ON, 1 the front-panel keys are locked.

OFF, 0 the front-panel keys are unlocked.

Query response is {1|0}.

### :SYSTem:LFRequency <numeric\_value>

Sets or queries the 4338B's operating power line frequency. The available line frequency selections are 50 Hz and 60 Hz.

<numeric\_value> is,

*numeric* 50 or 60 (integer)

**:SYSTem:PRESet**

Resets the 4338B to its default states. (no query)

The reset states are as follows:

Auto measurement	: ON
Source delay	: 0 ms
Measurement parameter	: R (resistance)
Deviation measurement	: OFF
Measurement range	: Auto
Measurement time	: MEDium
Averaging	: 1
Trigger mode	: Internal
Trigger delay	: 0 ms
Comparator	: OFF
Display mode	: Measured data
Beep	: FAIL beep mode
Data transfer format	: ASCII

**:SYSTem:VERSion?**

Returns the value corresponding to SCPI version number for which the 4338B complies. (Query only)

Query response is *YYYY.V*, in <NR2> format.

Where,

<i>YYYY</i>	year-version
<i>V</i>	revision number for the year

## TRIGGER Subsystem

The TRIGGER subsystem controls measurement trigger functions.

COMMAND	PARAMETER
TRIGGER	
[:SEQUENCE1]	
:DELAY	<numeric_value>[MS S]
[:IMMEDIATE]	
:SOURCE	{BUS EXTERNAL INTERNAL MANUAL}
:SEQUENCE2	
:DELAY	<numeric_value>[MS S]

### **:TRIGGER[:SEQUENCE1]:DELAY** <numeric\_value>[MS|S]

Sets or queries the source delay time.

<numeric\_value> is,

<i>numeric</i>	0 to 9999 ms, 1 ms resolution. The default is 0 s.
MAXimum	9999 ms
MIMimum	0 ms

The following suffixes can be used with <numeric\_value>.

S : s            MS : ms

### **:TRIGGER[:SEQUENCE1][:IMMEDIATE]**

Causes the trigger system to execute a measurement, regardless of the trigger state. (No query)

### **:TRIGGER[:SEQUENCE1]:SOURCE** { BUS | EXTERNAL | INTERNAL | MANUAL }

Sets or queries the trigger mode.

BUS	GET command and *TRG command triggers a single short measurement.
EXTERNAL	TTL pulse input through the rear panel external trigger connector or through the handler interface triggers a measurement.
INTERNAL	makes free running continuous measurements.
MANUAL	The 4338B performs a measurement in response to the front-panel trigger key being pressed.

Query response is {BUS|EXTERNAL|INTERNAL|MANUAL}.

### **:TRIGGER:SEQUENCE2:DELAY** <numeric\_value>[MS|S]

Sets or queries the trigger delay time.

<numeric\_value> is,

<i>numeric</i>	0 to 9999 ms, 1 ms resolution. Default is 0 s.
MAXimum	9999 ms
MIMimum	0 ms

The following suffixes can be used with <numeric\_value>.

S : s            MS : ms

---

## Common Commands

**\*CLS**

The \*CLS (clear status) command clears the status byte register, the operation status event register, the questionable status register, and the standard event status register.

**\*ESE** <numeric\_value>

Sets the bits of Standard Event Status Enable Register.

**\*ESE?**

The \*ESE? (Event Status Enable) query reads the bits in the standard event status enable register.

Query response is the decimal expression of the contents of the register, in <NR1> format.

**\*ESR?**

The \*ESR? (standard event status register) query returns the contents of the standard event status register.

Query response is the decimal expression of the contents of the register, in <NR1> format.

**\*IDN?**

The \*IDN? (identification) query returns an identification string which consist of 4 fields separated by commas.

Query response is <Field 1>,<Field 2>,<Field 3>,<Field 4>.

Where,

<i>Field 1:</i>	manufacturer (always HEWLETT-PACKARD)
<i>Field 2:</i>	model number (always 4338A)
<i>Field 3:</i>	serial number in HP format (like 2419J00100)
<i>Field 4:</i>	firmware version number (like 01.00)

**\*LRN?**

The \*LRN? (learn Device Setup) query returns a sequence of commands that places the 4338B in the current state. The returned sequence of commands can be sent back to the 4338B to place it in this state.

**\*OPC**

The \*OPC (OPERation Complete) command tells the 4338B to set bit 0 (OPC bit) in the standard event status register when it completes all pending operations.

**\*OPC?**

The \*OPC? (Operation Complete) query places an ASCII character 1 into the 4338B's Output Queue when all pending operations have been completed.

**\*OPT?**

The \*OPT? (OPTION identification) query tells the 4338B to identify the options installed in the system interface.

**\*RCL** *<numeric\_value>*

The \*RCL (recall) command recalls the instrument state which was stored in the specified register number. The 4338B has 10 available storage registers (0 through 9).

*<numeric\_value>* is,

*numeric*                    0 to 9, <NR1> format

**\*RST**

The \*RST (reset) command returns the 4338B to the default state (see :SYSTem:PRESet command) and sets the following commands:

```
INITiate:CONTinuous OFF
[SENSe:]CORRection[:STATe] OFF
SYSTem:KLOCK OFF
```

**\*SAV** *<numeric\_value>*

The \*SAV (save) command saves the instrument state in the specified register. The 4338B has 10 available storage registers (0 through 9).

*<numeric\_value>* is,

*numeric*                    0 to 9, <NR1> format

**\*SRE** *<numeric\_value>*

The \*SRE (service request enable) command sets the bits of the service request enable register.

*<numeric\_value>* is,

*numeric*                    decimal expression of the contents of the service request enable register (Bit 6 must be always 0), in <NR1> format

**\*SRE?**

The \*SRE? (service request enable) query returns the contents of the service request enable register.

Query response is the decimal expression of the contents of the register (Bit 6 is always 0), in <NR1> format.

**4338B****\*WAI****\*STB?**

The \*STB? (status byte) query reads the status byte by reading the master summary status bit. Query response is the decimal expression of the contents of the status byte register, in <NR1> format.

**\*TRG**

The \*TRG (trigger) command triggers the 4338B when the trigger mode is set to the bus trigger mode.

**\*TST?**

The \*TST? (self-test) query executes an internal self-test and returns the test result as the sum of all existing errors codes. If there are no error the 4338B returns 0.

Test Item	Error Code
1. RAM read/write	1
2. EPROM	2
3. Calibration data (EEPROM)	4
4. User's data (EEPROM)	8
5. AD converter	16
6. Backup RAM	32

Query response is 0 to 63, in <NR1> format.

**\*WAI**

The \*WAI (the wait to continue) command makes the 4338B wait until all previously sent commands are completed.



## Status Reporting Structure

This section provides information about the status reporting structure for Service Request functions which correspond to SCPI.

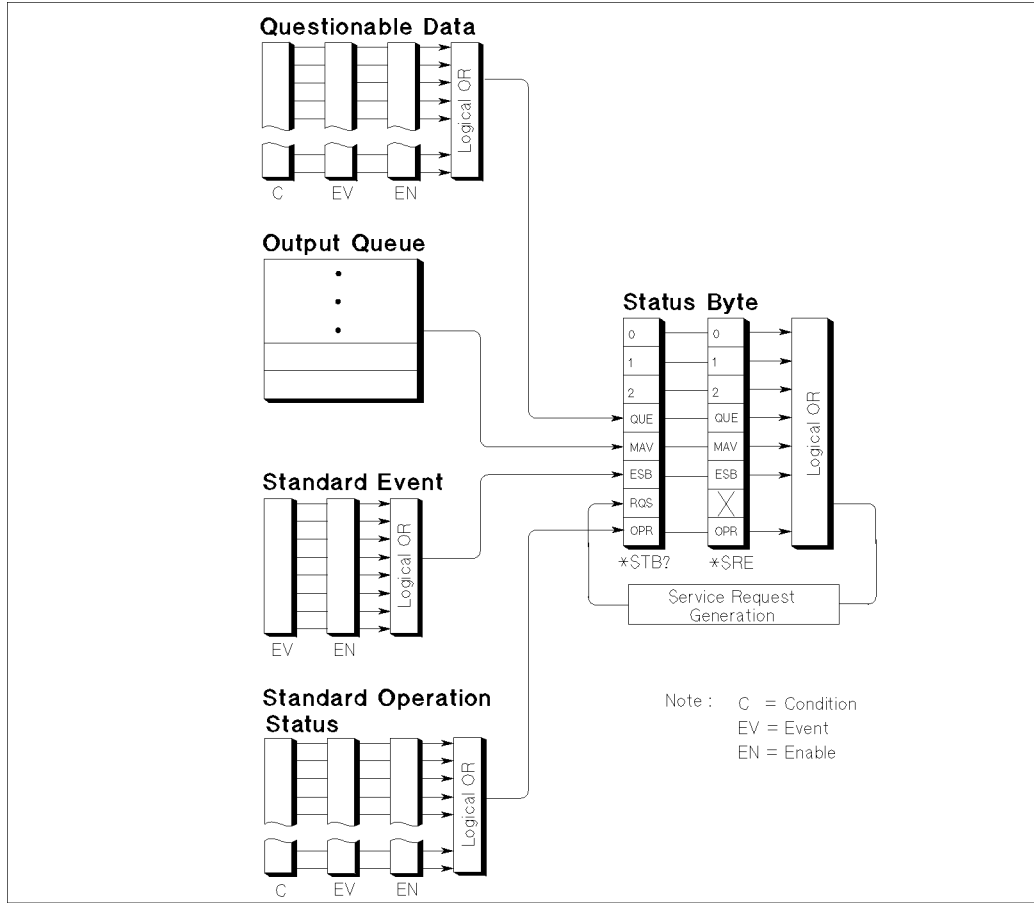

Figure 5-2. Status Reporting Structure

### Service Request (SRQ)

The 4338B can send an SRQ (Service Request) control signal when it requires the controller to perform a task. When the 4338B generates an SRQ, it also sets Bit 6 of the status byte, RQS (Request Service) bit. Service Request Enable Register allows an application programmer to select which summary messages in the status byte register may cause service requests. (Illustrated in Figure 5-3.)

### Status Byte Register

The status byte register is composed of eight bits that summarize the overlaying status data structure.

The status byte can be read using either \*STB? or SPOLL, which returns the decimal expression of the contents of the register (equal to the sum of the total bit weights of all bits set to “1”). For more information, see “To Report the Instrument’s Status” in Chapter 4.

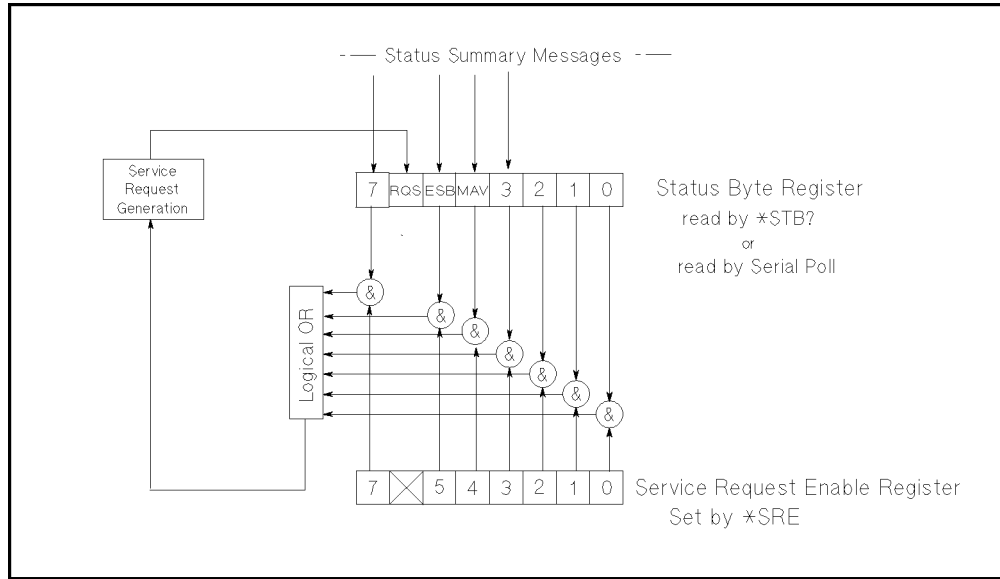

Figure 5-3. Status byte Register

Bits are set to “1” and reset to “0”.

Table 5-3. Status Byte Assignments

Bit No.	Bit Weight	Description
7	128	Operation Status Register Summary Bit
6	64	Request Service Bit—This bit is set when the any enabled bit of the status byte has been set, which indicates 4338B has at least one reason for requesting service. SPOLL resets this bit.
5	32	Standard Event Status Register Summary Bit
4	16	MAV (Message Available) Bit—This bit is set whenever the 4338B has data available in Output Queue, and is reset when the available data is read.
3	8	Questionable Status Register Summary Bit
2-0		always 0 (zero)

### Standard Event Status Register

The Standard Event Status Register is frequently used and is one of the simplest. You can program it using GPIB common commands, \*ESE and \*ESR?. Refer to the \*ESE and \*ESR? commands in “GPIB Commands”.

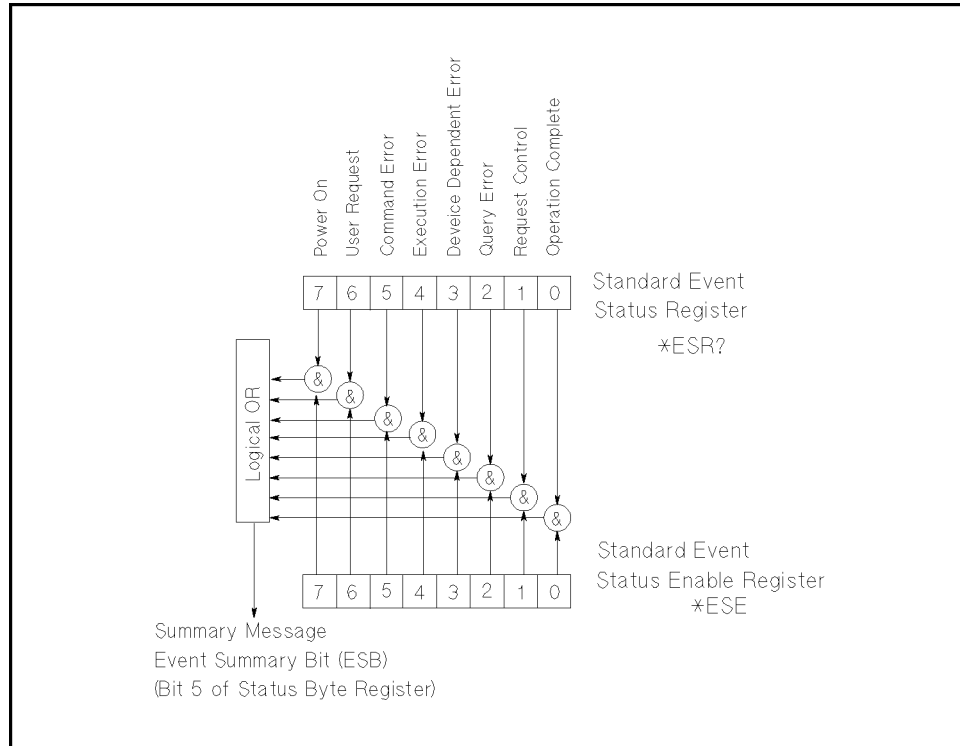

Figure 5-4. Standard Event Status Register

Table 5-4. Standard Event Status Register Assignments

Bit No.	Bit Weight	Description
7	128	Power-On Bit—This bit is set when the 4338B has been turned OFF and then ON again since the last time this register was read.
6		always 0 (zero)
5	32	Command Error Bit—This bit is set if the following the command errors occur. <ul style="list-style-type: none"> <li>•An IEEE 488.2 syntax error occurred.</li> <li>•The 4338B received a Group Execute Trigger (GET) inside a program message.</li> </ul>
4	16	Execution Error Bit—This bit is set when a parameter of a GPIB command was outside of its legal input range or is otherwise inconsistent with the 4338B’s capabilities.
3	8	Device-Dependent Error Bit—This bit is set when so many errors have been occurred that the error queue is full.
2	4	Query Error Bit—This bit is set to “1” when reading data from the output buffer and no data was present, or when the data was lost.
1		always 0 (zero)
0	1	Operation Complete Bit—This bit is set when the 4338B has completed all selected pending operations before sending the *0PC command.

### Standard Operation Status Group

The 4338B provides two standard operation status groups—operation status register group and questionable status register group which can be accessed using the STATus subsystem commands. (Refer to STATus subsystem in “GPIB Commands”.) If you are a beginner, you will rarely need to use this group. The individual bit assignments of these registers are given “Operation Status Register” and “Questionable Status Register” later in this section.

Each group includes a condition register, an event register, and an enable register.(Illustrated in Figure 5-5.)

The condition register reflects the internal states of 4338B. So each time the 4338B’s condition is changed, its condition bit is changed from “0” to “1”, or from “1” to “0”.

The event register’s bits correspond to the bits in the condition register. The transition filter reports to the event register that an event (a bit changed from “1” to “0”) has taken place in the condition register.

The enable register enables the corresponding bit in the event register to set the status summary bit, bit 7, or bit 3 of the status byte.

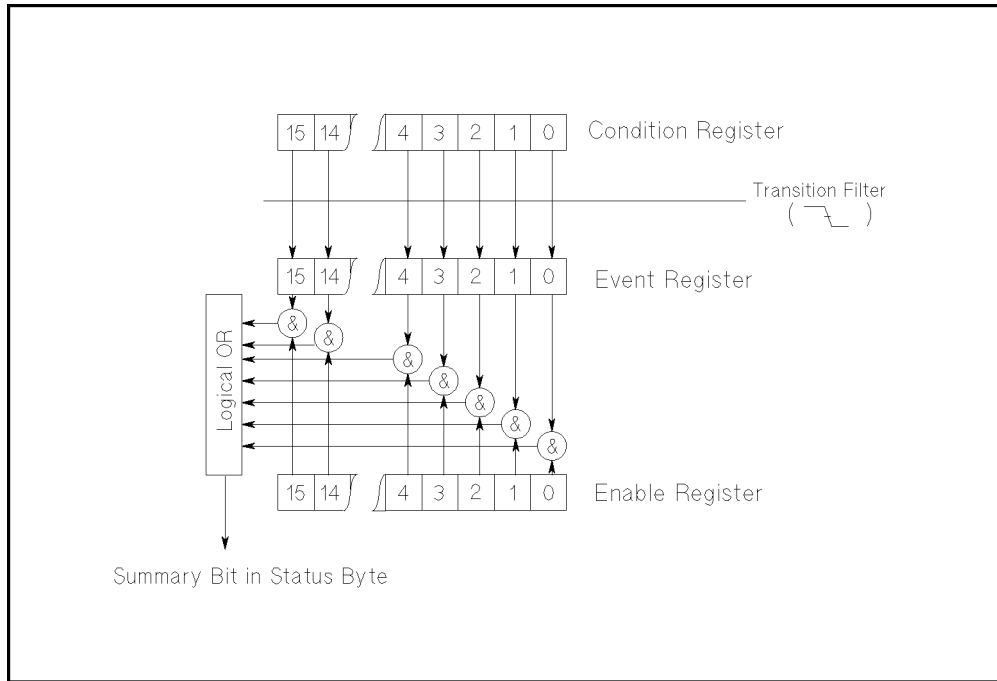

Figure 5-5. Standard Operation Status Group Structure

### Operation Status Register

The Operational Status Register group provides information about the state of the 4338B measurement system.

**Table 5-5. Operation Status Condition Register Assignments**

Bit No.	Bit Weight	Description
10-15		always 0
9	512	BUF2 is full.
8	256	BUF1 is full.
7	128	Correcting—The 4338B is currently performing a correction procedure.
6		Always 0
5	32	Waiting for Trigger—The 4338B is in a “waiting for trigger” state of the trigger model.
4	16	Measuring—The 4338B is actively measuring.
3		Always 0
2	4	Ranging—The 4338B is currently changing its range.
1	2	Settling—The 4338B is waiting for signals it controls to stabilize enough to begin measurement.
0		Always 0

**Table 5-6. Operation Status Event Register Assignments**

Bit No.	Bit Weight	Description
10-15		Always 0 (zero)
9	512	This bit is set when the BUF2 has become full.
8	256	This bit is set when the BUF1 has become full.
7	128	This bit is set when the correction data measurement has completed.
6		Always 0 (zero)
5	32	This bit is set when the 4338B has become able to accept a trigger.
4	16	This bit is set when the measurement has completed.
3		Always 0 (zero)
2	4	This bit is set when the ranging has completed.
1	2	This bit is set when the settling has completed.
0		Always 0 (zero)

### Questionable Status Register

The Questionable Status Register group provides information about the quality of the 4338B’s output and measurement data.

The 4338B has no operation to report an event to the questionable status register, all of whose bits are always set to 0.

**Table 5-7. Questionable Status Register Assignments**

Bit No.	Bit Weight	Description
15-0		Always 0

## Trigger System

This section provides information about the 4338B's trigger system. SCPI defines the common trigger model for several types of instruments. This trigger system allows you to have detailed control of the measurement process.

The description of the following information requires more technical expertise than most other topics covered in this chapter. But you can avoid the need to learn the information in this section by using the `INITiate` commands to make your measurements.

### 4338B Trigger System Configuration

The trigger system synchronizes the 4338B measurement with specified events. The events include GPIB trigger commands or a trigger pulse input through the rear panel External Trigger connector. The Trigger system also allows specifying the number of times to repeat a measurement and the delay time between measurements.

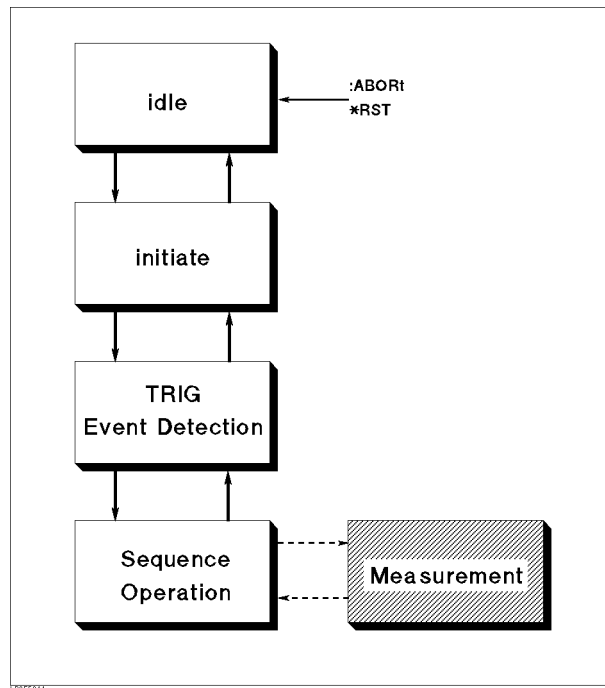

Figure 5-6. Trigger System Configuration

Figure 5-6 shows the logical configuration of the 4338B's trigger system. Each undashed block is called a **trigger state**. The 4338B moves between adjacent trigger states depending on its condition. The power ON state is called the **idle** state. You can force the 4338B to the idle state using the `:ABORt` or `*RST` commands. The **initiate** and **TRIGger Event Detection** state causes the 4338B program to branch when specified conditions are met. The **Sequence Operation** state signals the instrument hardware to take a measurement and then listens for confirmation that the measurement has been taken.

#### Idle State

The trigger system remains in the idle state until it is initiated by `INITiate:IMMediate` or `INITiate:CONTinuous ON`. Once one of these conditions is satisfied, the trigger system exits downward to the **initiate state**. Note that `*RST` sets `INITiate:CONTinuous OFF`.

## Initiate State

If the trigger system is on a downward path, it travels directly through the initiate state without restrictions. If the trigger system is on an upward path, and `INITiate:CONTinuous` is ON, then it exits downward to an event detection state. If the trigger system is on an upward path and `INITiate:CONTinuous` is OFF, then it exits upward to the idle state.

## Event Detection State

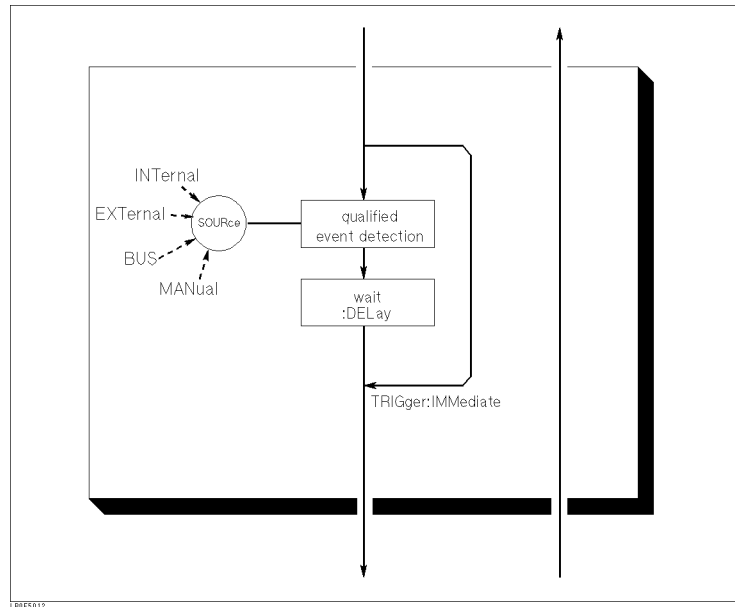

**Figure 5-7. Inside an Event Detection State**

**SOURCE** The `:TRIGger:SOURce` command specifies which particular input can generate the event required to continue the downward trigger path. If the source chosen is a non-analog signal such as `BUS`, then no further qualifications are required to generate an event. However, if an `INTernal` or `EXTernal` analog signal is chosen, additional qualifications may apply.

**DELay** The `:TRIGger:DELay` command allows you to specify a time delay after the trigger signal is detected to the start of the measurement. For example, you may want to delay acquiring data until 5 milliseconds after the positive edge to allow the measurement signal to settle. For example using a delay time allows relay contacts to stop bouncing before making a measurement. Sending `*RST` sets `DELay` to zero.

**IMMediate** The `:TRIGger:IMMediate` command bypasses event detection, `DELay` qualifications one time. The upward path through the event detection state contains only one condition. If the condition is satisfied, the trigger system exits upward.

## Sequence Operation State

The downward entrance to the sequence operation state forces the 4338B to start a measurement. An upward exit is not allowed until the measurement is complete.

## Data Transfer Format

### ASCII Format

Numeric data is transferred as ASCII byte in <NR1>(integer), <NR2>(fixed point), or <NR3>(floating point) format, as appropriate. The numbers are separated by commas as specified in the IEEE 488.2 standard.

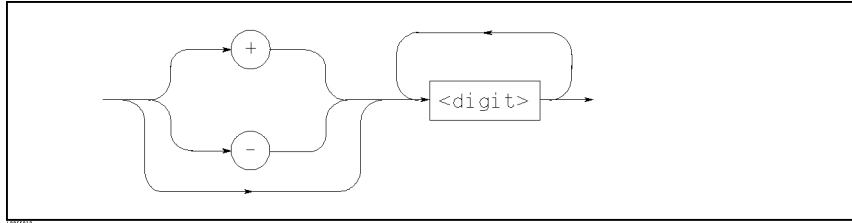

Figure 5-8. NR1 Format

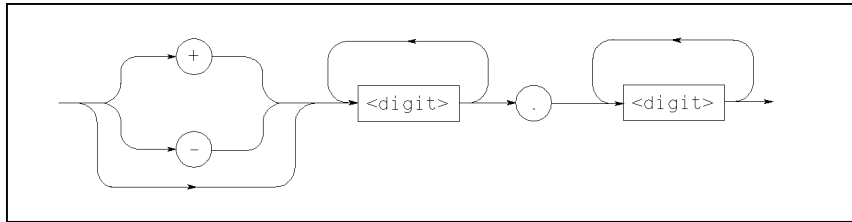

Figure 5-9. NR2 Format

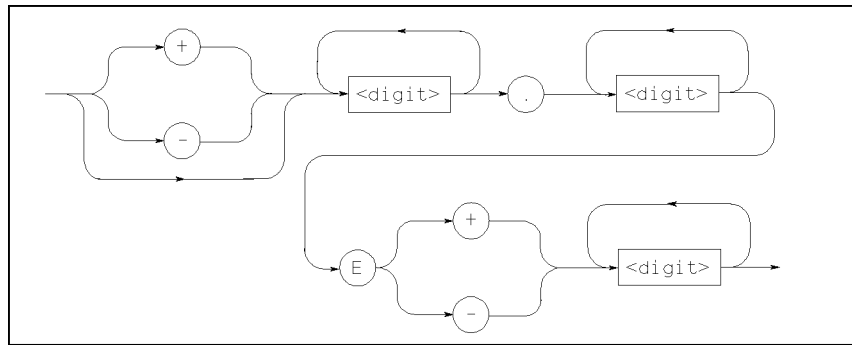

Figure 5-10. NR3 Format

For example, expression of "1000" are,

1000	<NR1> format
1000.0	<NR2> format
1.0E3	<NR3> format



**REAL Format**

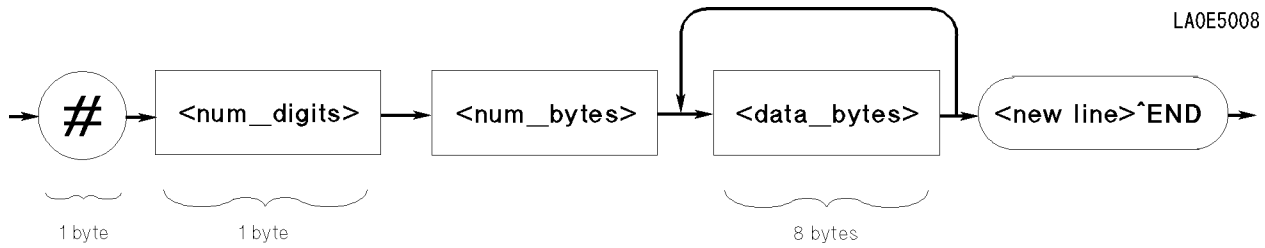

**Figure 5-11. Real Data Format**

This data field is initiated by a unique code, the number sign (#). The second byte, “<num\_digit>” designates the number of the bytes for the “<num\_bytes>”. “<num\_bytes>” designates “<data\_bytes>” length. “<new line>^END” is the response message terminator.

“<data\_bytes>” contains the data in the IEEE 754 floating point numbers of 64-bits. This is the same data format used by the HP Technical computers, such as the HP 9000 series 200/300 computers.

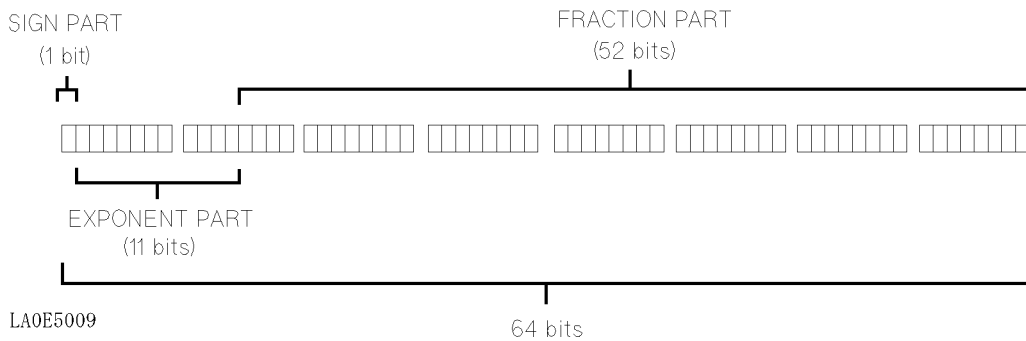

The real number RN represented in floating point format are provided by following formula:

- When  $0 < e < 1111111111$  (2047)  
 $RN = (-1)^S \times 2^{(EXP-1023)} \times (1 + f/2^{52})$
- When  $e = 0$   
 $RN = (-1)^S \times 2^{-1022} \times (f/2^{52})$
- When  $e = 0, f = 0$   
 $RN = 0$

Where,

- s value of the sign part (binary)
- e value of the exponential part (binary)
- EXP decimal expression of the exponential part
- f decimal expression of the fractional part

# Application Measurement

---

## Introduction

This chapter describes typical measurement applications:

- Measuring Contact Resistance of Relays or Switches
- Measuring Internal Resistance of Batteries

## Measuring Contact Resistance of Relays or Switches

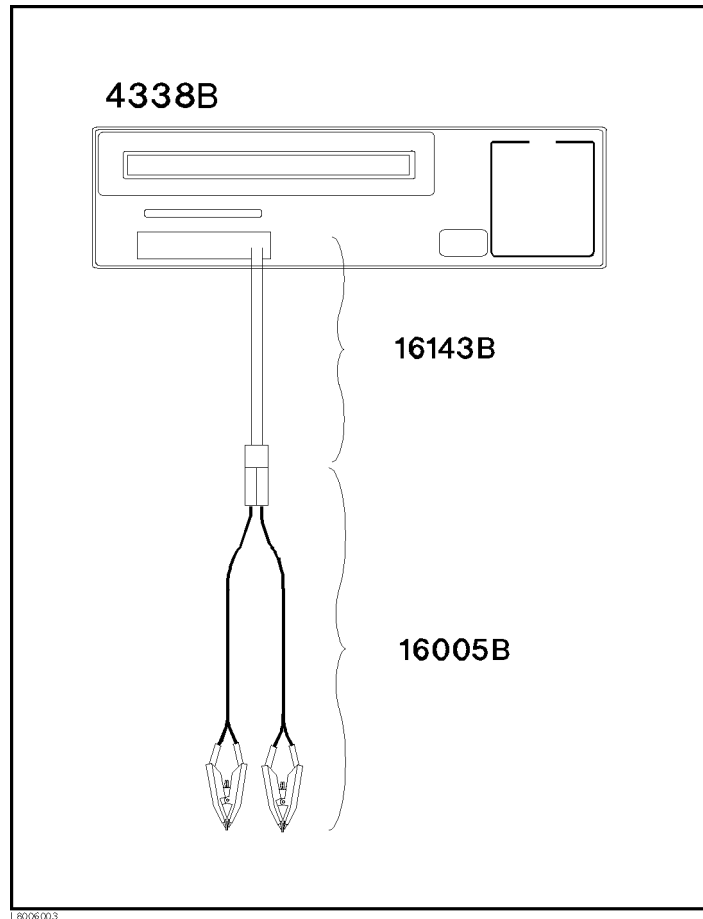

This example shows how to measure contact resistance of relays or switches.

1. Connect the 16143B mating adapter to the 4338B, then connect the 16005B Kelvin clip leads to the 16143B.



2. Select the R only measurement mode.

Press  to display the measurement parameter menu.

Press  or , until R is blinking, and press .

3. Activate the Auto Measurement mode.

Press  when the auto measurement indicator is OFF.



The Auto Measurement function allows the 4338B to measure a DUT automatically using the optimum measurement range and the test signal level.

4. Perform the SHORT compensation.

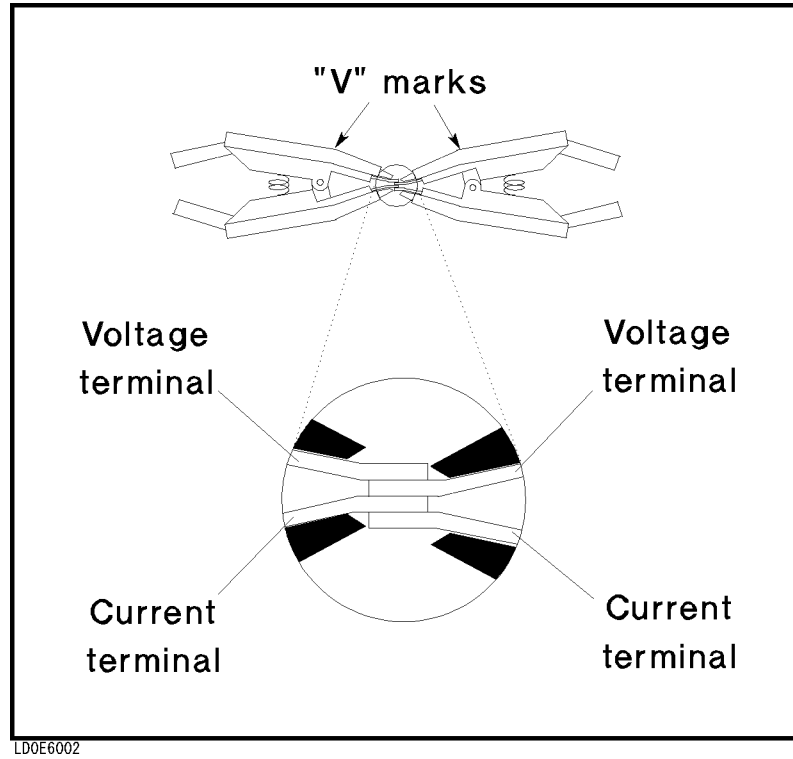
- a. Connect the 16005B Kelvin clip leads to each other.



b. Press  .

c. Press  or  until ShortMeas is blinking, and press .

5. Connect DUT.

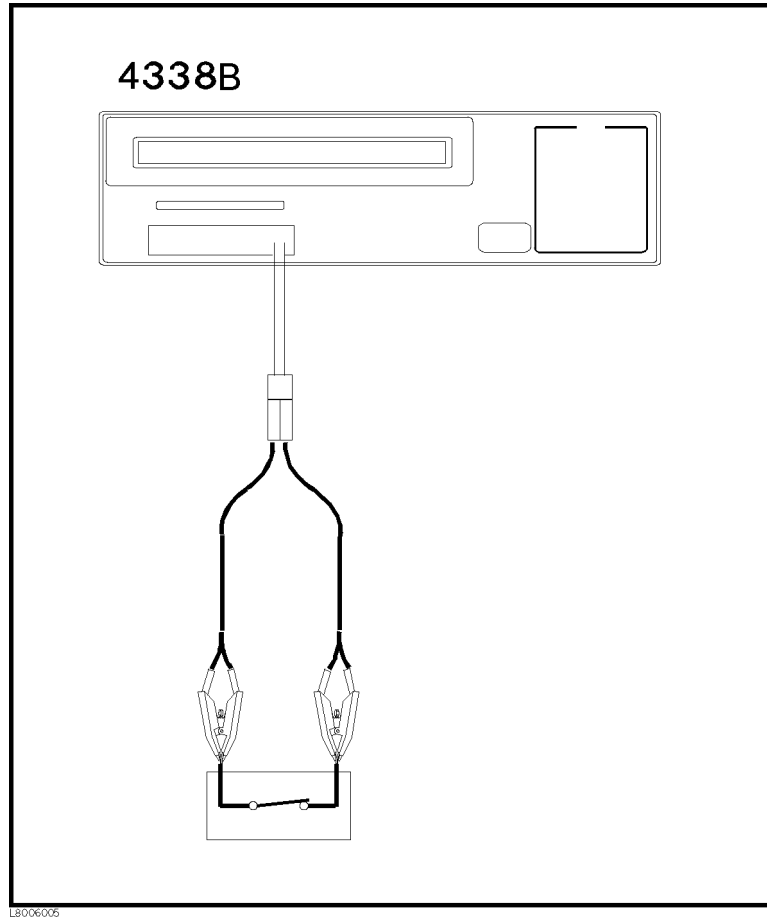
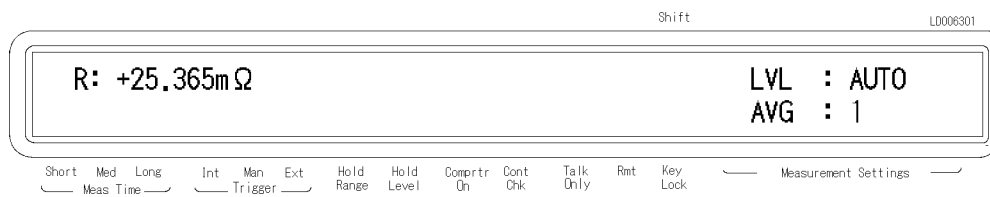

Figure 6-1. Measuring Contact Resistance

The following figure shows the typical measurement result display.



## Measuring Internal Resistance of Batteries

This example shows how to measure internal resistance of batteries using a handler.

1. The following figure is the typical measurement system using a handler. Refer to “Extending Test Leads” in Chapter 7 for the information on how to extend the test leads.

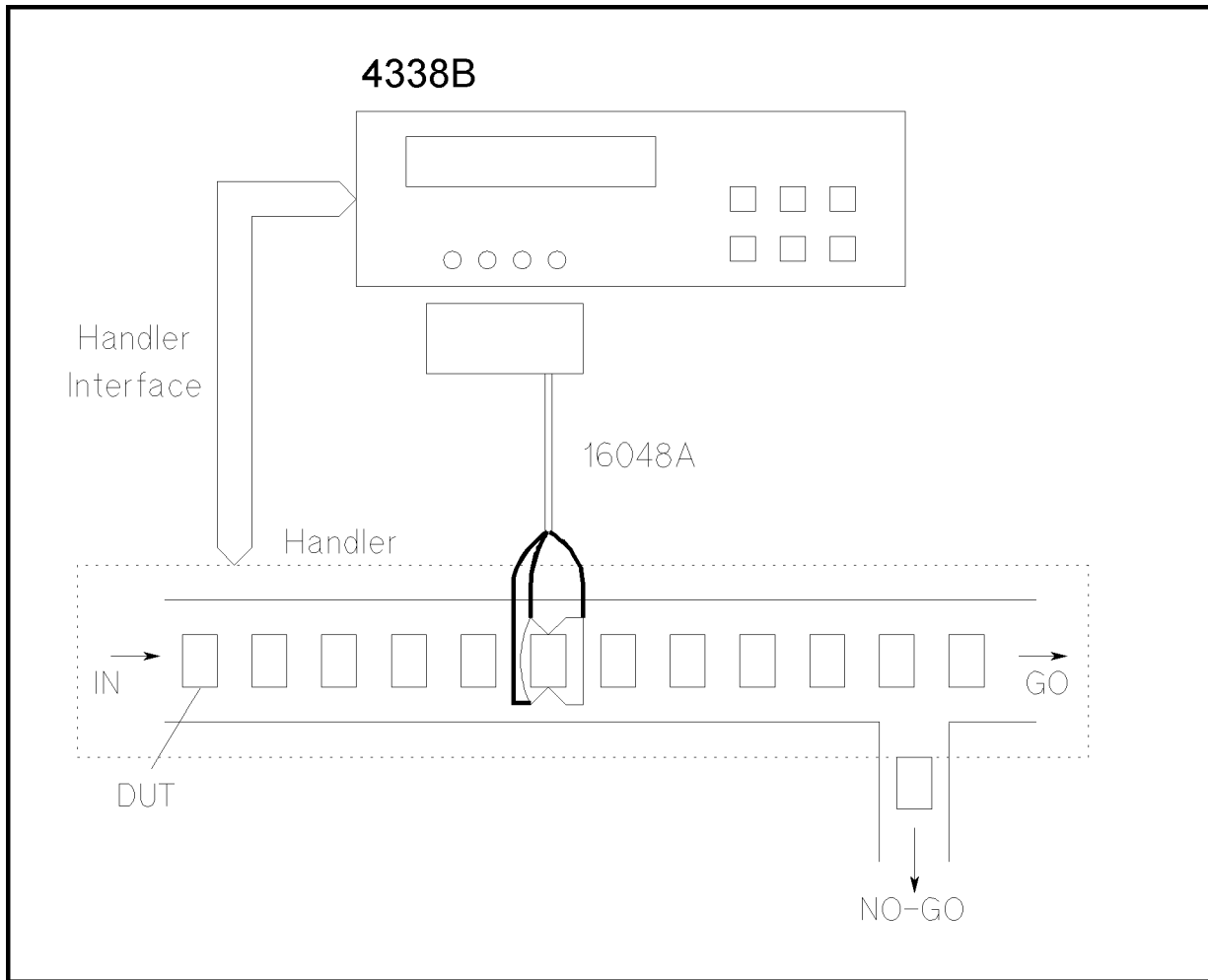

LS006004

**Figure 6-2. Measuring Internal Resistance of Batteries**

2. Run the following sample program.

```

10  OPTION BASE 1
11  DIM St(200),Dat(200),Comp(200)
12  Hp_ib=7
13  ASSIGN @Hp4338 TO 717
14  ASSIGN @Binary TO 717;FORMAT OFF
15  !
16  OUTPUT @Hp4338;"*RST"
17  OUTPUT @Hp4338;"*CLS"
18  !
19  OUTPUT @Hp4338;":CALC1:FORM REAL"
20  OUTPUT @Hp4338;":CALC2:FORM NONE"
21  OUTPUT @Hp4338;":SENS:FIMP:APER 0.03"
22  OUTPUT @Hp4338;":SENS:FIMP:RANG:AUTO OFF"
23  OUTPUT @Hp4338;":SENS:FIMP:RANG 0.1"
24  OUTPUT @Hp4338;":SOUR:CURR 0.001"
25  !
26  DISP "Short the test leads, then press 'Continue'."
27  PAUSE
28  OUTPUT @Hp4338;":SENS:CORR:COLL STAN2"
29  OUTPUT @Hp4338;"*0PC?"
30  ENTER @Hp4338;A
31  DISP "Connect the DUT, then press 'Continue'."
32  PAUSE
33  DISP
34  !
35  OUTPUT @Hp4338;":CALC1:LIM:LOW MIN; UPP 0.01"
36  OUTPUT @Hp4338;":CALC1:LIM:STAT ON"
37  OUTPUT @Hp4338;":DISP OFF"
38  OUTPUT @Hp4338;":TRIG:SOUR EXT"
39  OUTPUT @Hp4338;":FORM REAL"
40  !
41  OUTPUT @Hp4338;":DATA:POIN BUF1,200"
42  OUTPUT @Hp4338;":DATA:FEED BUF1,'CALC1'"
43  OUTPUT @Hp4338;":DATA:FEED:CONT BUF1,ALW"
44  !
45  OUTPUT @Hp4338;":STAT:OPER:ENAB ";DVAL("0000000100000000",2)
46  OUTPUT @Hp4338;"*SRE ";DVAL("11000000",2)
47  OUTPUT @Hp4338;":INIT:CONT ON"
48  !
49  ! Triggering
50  !
51  ON INTR Hp_ib GOTO Buffer_full
52  ENABLE INTR 7;2
53  LOOP
54  END LOOP
55  !
56  Buffer_full:OFF INTR
57  DISP "Buffer full."
58  OUTPUT @Hp4338;":DATA? BUF1"
59  ENTER @Binary USING "#,6A";A$
60  FOR I=1 TO 200
61  ENTER @Binary;St(I),Dat(I),Comp(I)

```

```

530  NEXT I
540  ENTER @Binary USING "#,1A";A$
550  !
560  FOR I=1 TO 200
570    PRINT "Status:";St(I),"R:";Dat(I);"[OHM]","Comp:";Comp(I)
580  NEXT I
590  END

```

**Figure 6-3. Application Sample Program**

Lines 70 and 80	Resets the 4338B and clears the status byte register.
Lines 100 and 110	Sets the measurement parameters to the R only mode.
Line 120	Sets the measurement time mode to SHORT.
Line 130 and 140	Sets the measurement range to 100 mΩ range.
Line 150	Sets the test signal level to the 1 mA.
Lines 170 to 240	Performs the SHORT correction.
Lines 260 and 270	Set the comparator lower limit to OFF and the upper limit to 10 mΩ, and enables the comparator function.
Line 280	Clears the LCD display.
Line 290	Sets the trigger source to the External.
Line 300	Sets the data transfer format to the 64-bit real transfer format.
Lines 320 to 340	Set the size of the data buffer BUF1 to 200, set to feed the R measurement data which was specified by :CALC1:FORM command, and feed data into the data buffer whenever the new data available.
Lines 360 and 370	Enables the BUF1 full bit of the operation status register, and the operation status register summary bit of the status byte register.
Line 380	Sets the trigger system as being continuously initiated.
Line 400	Triggers the measurement from the external trigger source.
Lines 420 to 450	Wait until the data buffer is full.
Line 490	Returns the data held in the data buffer.
Lines 500 to 540	Retrieve the 64-bit real transfer format data. Line 500 gets the header, lines 510 to 530 gets the measurement data, and line 540 gets the terminator.
Line 560 to 580	Print the measurement data.

---

**Caution**  Do not connect batteries whose voltage is more than ±42 V, or the 4338B will be damaged.







## Measurement Basics

### Introduction

This chapter provides information that will help you work more effectively.

### SHORT Correction

The SHORT correction function reduces the measurement error due to the residual impedance existing between the 4338B's UNKNOWN terminals and the DUT.

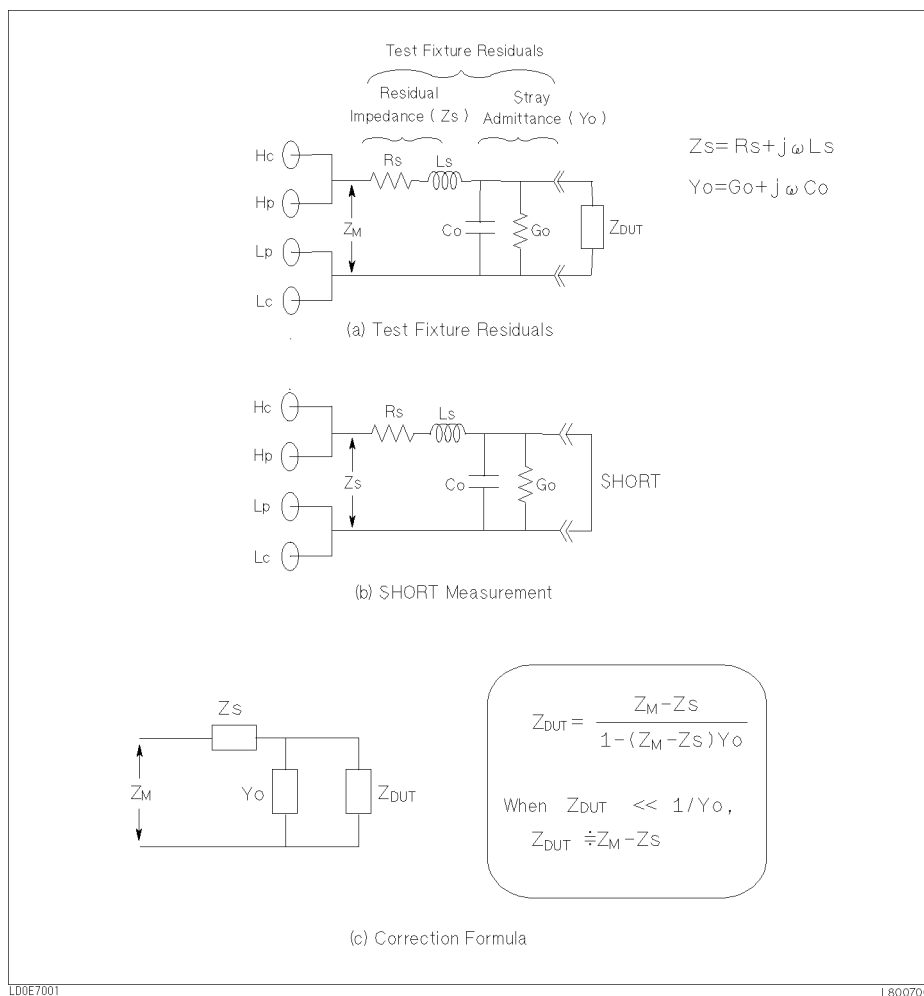

Figure 7-1. SHORT Correction

The measured impedance,  $Z_M$ , contains the measurement errors. Figure 7-1 (a) shows the existence of residual impedance between the UNKNOWN terminals and the DUT, which is due to the test fixture. If the DUT's impedance,  $Z_{DUT}$ , is low, the test fixture's residual impedance has more effect on a measurement than does the fixture's stray admittance. The 4338B has a SHORT correction function to cancel the residual impedance of the test fixture so low impedance devices can be accurately measured.

Figure 7-1 (b) describes the SHORT measurement technique which measures the residual impedance of the test fixture,  $Z_s$ . A SHORT measurement is performed by connecting the test electrodes directly together or connecting a shorting device to the electrodes. The residual impedance of the shorting device must be significantly lower than the DUT's impedance, otherwise it will directly affect the measurement results.

After the SHORT measurement is performed, the DUT's impedance,  $Z_{DUT}$ , is calculated using the equation given in Figure 7-1 (c).

---

## Measurement Range

For any measurement range, the maximum accuracy is obtained when the measured impedance is close to the full-scale value of the measurement range being used. Conversely, if the measured impedance is much lower than the full-scale value of measurement range being used, the measurement accuracy will be reduced. This sometimes cause a discontinuity occurs in the measurement values at the measurement range boundaries. If measurement range is set to Auto range, the impedance curve will skip when impedance range change occurs. To prevent this from occurring, the impedance range should be set to the Hold range mode.

---

## Dry Circuit Loop

When the voltage applied between the contacts is high, the oxidation film which is formed between the contact is destroyed, and the resistance value measured may be smaller than under actual use. Moreover, once the oxidation film is destroyed, the contact will never recover the its former condition, even if the voltage across the contact is cut off.

According to the recommended standards of the International Electrotechnical Commission (IEC), measurement of contact resistance using ac test signal should be conducted using instruments whose test signal peak voltage values are 20 mV or less.

The 4338B's test voltage level goes to 0 V if the peak voltage value across the DUT exceeds 20 mV. The 4338B's dry circuit loop prevents the test signal voltage applied across the DUT from exceeding 20 mV. Thus, even when an unknown DUT is measured without special preparation, the contact resistance is still accurately measured without disturbing the state of the contacts.

## Extending Test Leads

When you want to use the 4338B with the handler or to make a test fixture, use the connection methods shown in Figure 7-2. The names in the parenthesis are the terminals on the 4338B's front panel. The  $L_{CUR}$  terminal is not used for measurement.

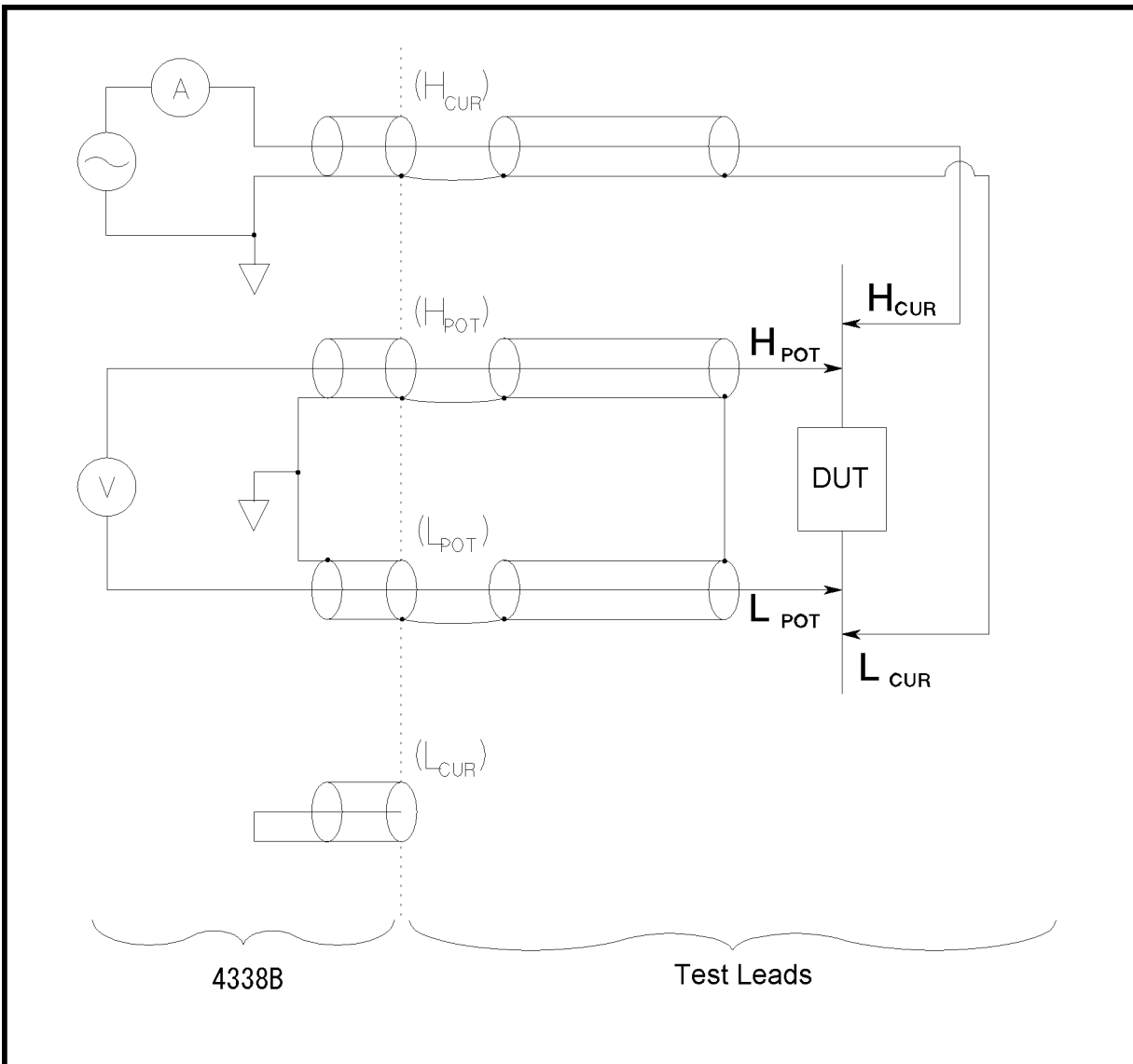

LD0E7003

Figure 7-2. Test Lead Extension



# General Information

---

## Introduction

This chapter provides the following general information for the 4338B:

- Specifications
- Supplemental Performance Characteristics

## Specifications

### Measurement Parameter

R (AC resistance), X (Reactance), L (Inductance), |Z| (Impedance),  $\theta$  (Phase)

### Measurement Conditions

- Test Signal Characteristics
  - Test Frequency
    - 1 kHz  $\pm$ 0.1%
  - Test Signal Level
    - 1  $\mu$ , 10  $\mu$ , 100  $\mu$ , 1 m, 10 mA<sub>rms</sub>
  - Maximum Voltage Across Sample
    - 20 mV peak
- Measurement Time Mode
  - Short, Medium, and Long
- Ranging
  - Auto and Hold (manual)
- Averaging
  - 1 to 256
- Trigger Mode
  - Internal, Manual, External, and Bus
- Trigger Delay Time
  - 0 to 9.999 seconds in 0.001 seconds steps
- Source Delay Time
  - 0 to 9.999 seconds in 0.001 seconds steps
- Test Cable Length
  - 2 meters maximum

### Measurement Range

Parameter	Measurement Range	Contact Check
R	10 $\mu$ to 100 k $\Omega$	Off
	10 $\mu$ to 10 k $\Omega$	On

**Measurement Accuracy**

The following conditions must be met:

1. Warm up time:  $\geq 15$  min
2. Short correction has been performed

Accuracy applies when  $X/R \leq 2$ .

Multiply the accuracy by the following temperature induced error factors.

$$18\text{ }^{\circ}\text{C} \leq T \leq 28\text{ }^{\circ}\text{C} : \times 1$$

$$8\text{ }^{\circ}\text{C} \leq T < 18\text{ }^{\circ}\text{C}, \text{ or } 28\text{ }^{\circ}\text{C} < T \leq 38\text{ }^{\circ}\text{C} : \times 2$$

$$0\text{ }^{\circ}\text{C} \leq T < 8\text{ }^{\circ}\text{C}, \text{ or } 38\text{ }^{\circ}\text{C} < T \leq 45\text{ }^{\circ}\text{C} : \times 4$$

Where, T is the temperature.



Table 8-1. Measurement Accuracy

Rm <sup>1</sup> [Ω]	Measurement Accuracy <sup>2</sup> (± % of reading)					
	Measurement Signal Current [A]					
	1 μ	10 μ	100 μ	1 m	10 m	
100 k	$0.85 + \frac{0.001}{R_m} + \frac{R_m}{1869}$ $0.4 + \frac{0.001}{R_m} + \frac{R_m}{1961}$ $0.4 + \frac{0.001}{R_m} + \frac{R_m}{1990}$					
10 k						$0.85 + \frac{3500.001}{R_m} + \frac{R_m}{2000}$ $0.4 + \frac{1000.001}{R_m} + \frac{R_m}{2000}$ $0.4 + \frac{250.001}{R_m} + \frac{R_m}{2000}$
1 k						
100	$0.85 + \frac{100.001}{R_m} + \frac{R_m}{2000}$ $0.4 + \frac{15.001}{R_m} + \frac{R_m}{2000}$ $0.4 + \frac{4.001}{R_m} + \frac{R_m}{2000}$	$0.85 + \frac{17.001}{R_m} + \frac{R_m}{2000}$ $0.4 + \frac{5.001}{R_m} + \frac{R_m}{2000}$ $0.4 + \frac{1.301}{R_m} + \frac{R_m}{2000}$	$0.85 + \frac{35.001}{R_m} + \frac{R_m}{2000}$ $0.4 + \frac{10.001}{R_m} + \frac{R_m}{2000}$ $0.4 + \frac{2.501}{R_m} + \frac{R_m}{2000}$			
10	$0.85 + \frac{50.001}{R_m}$ $0.4 + \frac{6.001}{R_m}$ $0.4 + \frac{1.501}{R_m}$	$0.85 + \frac{10.001}{R_m}$ $0.4 + \frac{1.501}{R_m}$ $0.4 + \frac{0.401}{R_m}$	$0.85 + \frac{1.701}{R_m}$ $0.4 + \frac{0.501}{R_m}$ $0.4 + \frac{0.131}{R_m}$			$0.85 + \frac{3.501}{R_m}$ $0.4 + \frac{1.001}{R_m}$ $0.4 + \frac{0.251}{R_m}$
1		$0.85 + \frac{5.001}{R_m}$ $0.4 + \frac{0.601}{R_m}$ $0.4 + \frac{0.151}{R_m}$	$0.85 + \frac{1.001}{R_m}$ $0.4 + \frac{0.151}{R_m}$ $0.4 + \frac{0.041}{R_m}$			$0.85 + \frac{0.171}{R_m}$ $0.4 + \frac{0.051}{R_m}$ $0.4 + \frac{0.014}{R_m}$
100 m			$0.85 + \frac{0.501}{R_m}$ $0.4 + \frac{0.061}{R_m}$ $0.4 + \frac{0.016}{R_m}$	$0.85 + \frac{0.101}{R_m}$ $0.4 + \frac{0.016}{R_m}$ $0.4 + \frac{0.005}{R_m}$	$0.85 + \frac{0.018}{R_m}$ $0.4 + \frac{0.006}{R_m}$ $0.4 + \frac{0.0023}{R_m}$	
10 m	$0.85 + \frac{0.051}{R_m}$ $0.4 + \frac{0.005}{R_m}$ $0.4 + \frac{0.0025}{R_m}$	$0.85 + \frac{0.011}{R_m}$ $0.4 + \frac{0.0025}{R_m}$ $0.4 + \frac{0.0014}{R_m}$				
1 m			$1.2 + \frac{0.051}{R_m}$ $1.2 + \frac{0.005}{R_m}$ $1.2 + \frac{0.0025}{R_m}$	$1.2 + \frac{0.006}{R_m}$ $1.2 + \frac{0.0014}{R_m}$ $1.2 + \frac{0.00115}{R_m}$		
100 μ						
10 μ						

1 Rm: Resistance Value [Ω]  
 2 Accuracy in the table represent:  
 Short mode  
 Medium mode  
 Long mode

## Measurement Support Functions

- **Correction Function (Zero Short)**

Eliminates measurement errors due to parasitic impedance in the test fixtures.
- **Display**

A 40-digit × 2-line LCD display.

Capable of displaying: Measured values (5 digits maximum), comparator/contact check decisions, comparator limits, control settings, self test messages, and annunciators. The displaying can be disabled.
- **Mathematical Functions**

The deviation and the percent deviation of measurement values from a programmable reference value.
- **Comparator Function**

HIGH/IN/LOW for each of the primary measurement parameter and the secondary measurement parameter.
- **Contact Check Function**

Detects contact failure between the test fixture and device to assume test integrity.
- **Superimposed DC**

Up to  $\pm 42$  V can be present on the measurement terminals.
- **Save/Recall**

Ten instrument setups can be saved and recalled from the internal non-volatile memory.
- **Continuous Memory Capability**

If the instrument is turned OFF, or if a power failure occurs, the instrument settings are automatically saved.
- **Key Lock**

Disables key input from the front panel.
- **GPIB Interface**

All control settings, measurement values, self-test results, and comparator information.

Complies with IEEE-488.1, 2. The programming language is SCPI. Talk-only mode available. Data buffer can store a maximum of 200 measurements.
- **Handler Interface**

All outputs signals are negative logic, optically isolated open collector outputs

  - Output Signals Include: HIGH/IN/LOW, no-contact, overload, index, end-of-measurement, and alarm
  - Input Signals Include: Keylock and external trigger

**General**

## ■ Power Requirements

100/120/220/240 V  $\pm$ 10%, 47 to 66 Hz  
45 VA max

## ■ Operating Temperature, Humidity and Altitude

0 to 45 °C,  $\leq$  95% RH @ 40 °C, 0 to 2000 meters

## ■ Storage Temperature, Humidity and Altitude

-40 to 70 °C,  $\leq$  90% RH @ 65 °C, 0 to 4572 meters

## ■ EMC

Complies with CISPR 11 (1990) / EN 55011 (1991) : Group 1, Class A.

Complies with EN 61000-3-3 (1995) / IEC 1000-3-3 (1994)

Complies with EN 50082-1 (1992) / IEC 801-2 (1991) : 4 kV CD, 8 kV AD.

Complies with EN 50082-1 (1992) / IEC 801-3 (1984) : 3 V/m.

Complies with EN 50082-1 (1992) / IEC 801-4 (1988) : 0.5 kV Signal Lines, 1 kV Power Lines.

This ISM device complies with Canadian ICES-001.

Cet appareil ISM est conforme à la norme NMB-001 du Canada.

## ■ Dimensions

approximately 320 (W) by 100 (H) by 300 (D) mm

## ■ Weight

approximately 4.5 kg

## Supplemental Performance Characteristics

The supplemental performance characteristics are listed below. These characteristics are not specifications but are typical characteristics included as supplemental information for the operator.

- Test Signal Level Accuracy  
 $\pm(10\% + 0.2 \mu\text{A})$
- Measurement Range

### Measurement Range when Contact Check is OFF

Parameter	Measurement Range
X,  Z	10 $\mu$ to 100 k $\Omega$
L	10 $\mu$ to 10 H
$\theta$ ( $\angle$ )	-180 to +180°

### Measurement Range when Contact Check is ON

Parameter	Measurement Range
X,  Z	10 $\mu$ to 10 k $\Omega$
L	10 $\mu$ to 1 H
$\theta$ ( $\angle$ )	-180 to +180°

- Continuous Memory Duration  
 72 hours (@ 23 $\pm$ 5 °C)
- Measurement Time

The following table shows typical measurement times.

Mode	Analog Measurement	Digital Computation	Total <sup>1</sup>
Short	27	7	34
Medium	63	7	70
Long	890	10	900

<sup>1</sup> Time interval from a trigger command to EOM (end of measurement) signal output at the handler interface port.  
 (@ ranging: hold, display mode: off)

At the lowest measurement range for each test current setting, each measurement time increases by sixteen times as shown below.

<b>Mode</b>	<b>Analog Measurement</b>	<b>Digital Computation</b>	<b>Total<sup>1</sup></b>
Short	432 ms	112 ms	544 ms
Medium	1008 ms	112 ms	1120 ms
Long	14240 ms	160 ms	14400 ms

<sup>1</sup> Time interval from a trigger command to EOM (end of measurement) signal output at the handler interface port.  
(@ ranging: hold, display mode: off)

## Maintenance

---

### Introduction

This chapter provides information on how to maintain the 4338B. 4338B maintenance consists of performance tests and functional tests.

---

### Test Equipment

Table 9-1 lists the recommended equipment for performing 4338B maintenance.

**Table 9-1. Required Equipment**

Equipment	Requirements	Recommended Model	Qty.	Use <sup>1</sup>
Frequency Counter	Frequency: 1 kHz Accuracy: $\leq 0.025\%$	5334B	1	P
RMS Voltmeter	Frequency: 1 kHz Voltage Range: 5 mV to 110 mV Accuracy: $\leq 2.5\%$	3458A	1	F
1 m $\Omega$ Standard Resistor	No Substitute	42031A <sup>2</sup>	1	P
10 m $\Omega$ Standard Resistor	No Substitute	42032A <sup>2</sup>	1	P
100 m $\Omega$ Standard Resistor	No Substitute	42033A <sup>2</sup>	1	P
1 $\Omega$ Standard Resistor	No Substitute	42034A <sup>2</sup>	1	P
10 $\Omega$ Standard Resistor	No Substitute	42035A <sup>2</sup>	1	P
100 $\Omega$ Standard Resistor	No Substitute	42036A <sup>2</sup>	1	P
1 k $\Omega$ Standard Resistor	No Substitute	16074A 42037A <sup>2</sup>	1	P
10 k $\Omega$ Standard Resistor	No Substitute	16074A 42038A <sup>2</sup>	1	P
SHORT Termination	No Substitute	16074A 42091A	1	P
Adapter	Dual Banana-BNC(f)	16074A PN 1251-2277	1	F
Cable	30 cm BNC(m)-BNC(m)	PN 8120-1838	1	P, F
	61 cm BNC(m)-BNC(m)	PN 8120-1839	1	P, F
Handler Interface Tester	No Substitute	PN 04339-65007	1	F

<sup>1</sup> P: Performance Tests, F: Functional Tests

<sup>2</sup> Part of 42030A Standard Resistor Set

---

## Performance Tests

### Introduction

This section provides the test procedures used to verify that the 4338B's specifications listed in Chapter 8 are met. All tests can be performed without access to the interior of the instrument. The performance tests can also be used to perform incoming inspection, and to verify that the 4338B meets its performance specifications after troubleshooting or adjustment. If the performance tests indicate that the 4338B is NOT operating within the specified limits, check your test setup, then proceed with troubleshooting if necessary.

---

**Note**

Allow the 4338B to warm up for at least 15 minutes before you execute any of the performance tests.

---

**Note**

Perform all performance tests in ambient conditions of  $23^{\circ}\text{C} \pm 5^{\circ}\text{C}$ ,  $\leq 70\%$  RH.

---

### Test Equipment

Table 9-1 lists the test equipment required to perform the tests described in this section. Use only calibrated test instruments when performance testing the 4338B. Equipment which equals or surpasses the key required specifications of the recommended equipment may be used as a substitute.

### Calculation Sheet

The calculation sheet is used as an aid for recording raw measurement data, and for calculating the performance test results.

The performance test procedure gives the test sequence for performing a test, the complete set of measurement data are recorded on the calculation sheet, the results are calculated using the equations given on the calculation sheet, and the results are transcribed to the performance test record.

The procedure for using the calculation sheet is:

1. Photo copy the calculation sheet.
2. Follow the performance test procedure and record the measurement value(s), the 4338B's reading, etc., into the specified column on the calculation sheet.
3. Calculate the test result using the appropriate equation given on the calculation sheet, and record the test result into the Test Result column of the performance test record.

**Performance Test Record**

Record the performance test results in the test record at the end of this chapter (Photocopy the test record and use the photocopy). The test record lists all test specifications, their acceptable limits, and measurement uncertainties for the recommended test equipment. Test results recorded during incoming inspection can be used for comparison purposes during periodic maintenance, troubleshooting, and after repair or adjustment.

**Calibration Cycle**

The 4338B requires periodic performance tests. The frequency of performance testing depends on the operating and environmental conditions under which the 4338B is used. Verify the 4338B's performance at least once a year, using the performance tests described in this section.



### Test Signal Frequency Accuracy Test

The 4338B's test signal frequency is measured with a frequency counter.





#### Specification

Test Signal Frequency: 1 kHz ± 0.1 %

#### Test Equipment

Description	Recommended Model
Universal Counter	5334B
30 cm BNC(m)-BNC(m) Cable	PN 8120-1838
61 cm BNC(m)-BNC(m) Cable	PN 8120-1839

#### Procedure

1. Reset the 4338B using the following procedure.
  - a. Press   to display the system reset menu.
  - b. Press  or  until Yes blinks, and press .
2. Set up the equipment as shown in Figure 9-1.

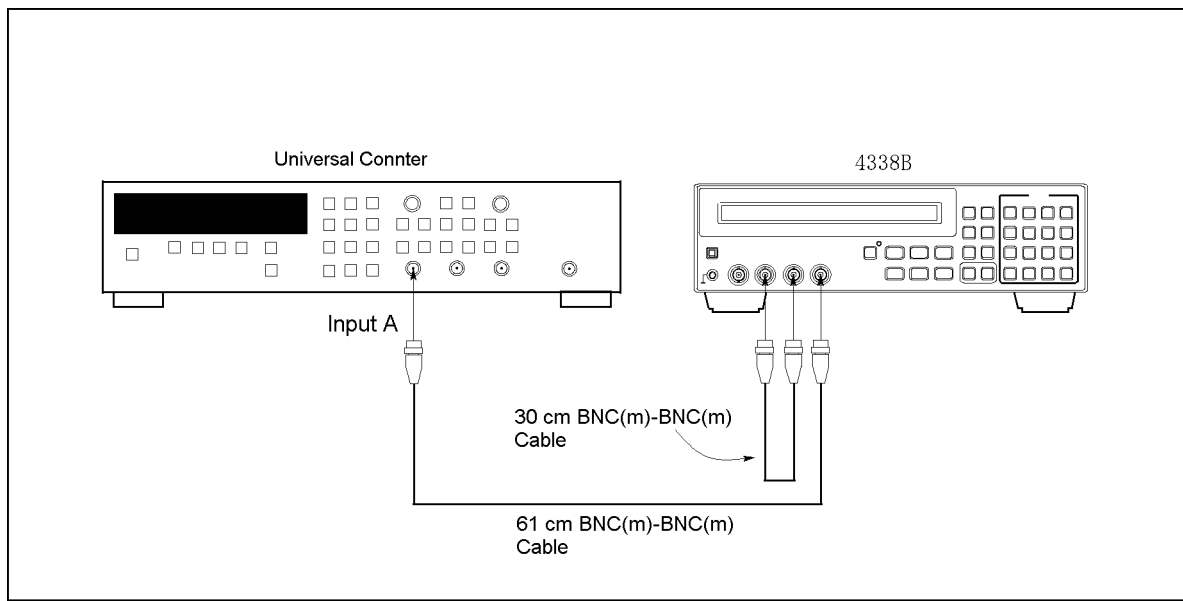















Figure 9-1. Test Signal Frequency Accuracy Test Setup

3. Set the test signal level to 10 mA using the following procedure.
  - a. Press  to display the test signal level setting menu.
  - b. Press  or  until 10 mA blinks, and press .

4. Set the trigger delay time to 9 seconds using the following procedure.
  - a. Press   to display the trigger/source delay setting menu.
  - b. Press  or  until TrigDelay blinks, and press .
  - c. Press , and press .
  - d. Press  or  until Exit blinks, and press .
5. Record the universal counter reading on the calculation sheet on the Counter Reading line.

---

**Note**

The counter may display strange frequency readings for a moment in this test, this is because the 4338B turns the test signal off after each measurement. The delay time, in which the 4338B outputs the test signal continuously, is used to ease the test signal frequency measurement.

---

6. Calculate the test result according to the calculation sheet, and record the result into the performance test record.

## Resistance Measurement Accuracy Test

Calibrated Standard Resistors are measured with the 4338B, and the measured values are compared with the standards' calibration values to determine the measurement accuracy of the 4338B.

### Specification

Basic Measurement Accuracy:  $\pm 0.4\%$  (See Chapter 8 General Information for details.)





### Test Equipment

Description	Recommended Model
1 m $\Omega$ Standard Resistor	42031A <sup>1</sup>
10 m $\Omega$ Standard Resistor	42032A <sup>1</sup>
100 m $\Omega$ Standard Resistor	42033A <sup>1</sup>
1 $\Omega$ Standard Resistor	42034A <sup>1</sup>
10 $\Omega$ Standard Resistor	42035A <sup>1</sup>
100 $\Omega$ Standard Resistor	42036A <sup>1,2</sup>
1 k $\Omega$ Standard Resistor	42037A <sup>1,2</sup>
10 k $\Omega$ Standard Resistor	42038A <sup>1,2</sup>
SHORT Termination	42091A <sup>2</sup>

<sup>1</sup> Part of 42030A Standard Resistor Set

<sup>2</sup> 16074A can be used as a substitute

### Procedure

- Record the 42030A Standard Resistor Set's calibration values on the calculation sheet.
- Reset the 4338B using the following procedure.
  - Press   to display the system reset menu.
  - Press  or  until Yes blinks, and press .
- Connect the SHORT termination to the 4338B's UNKNOWN terminals.

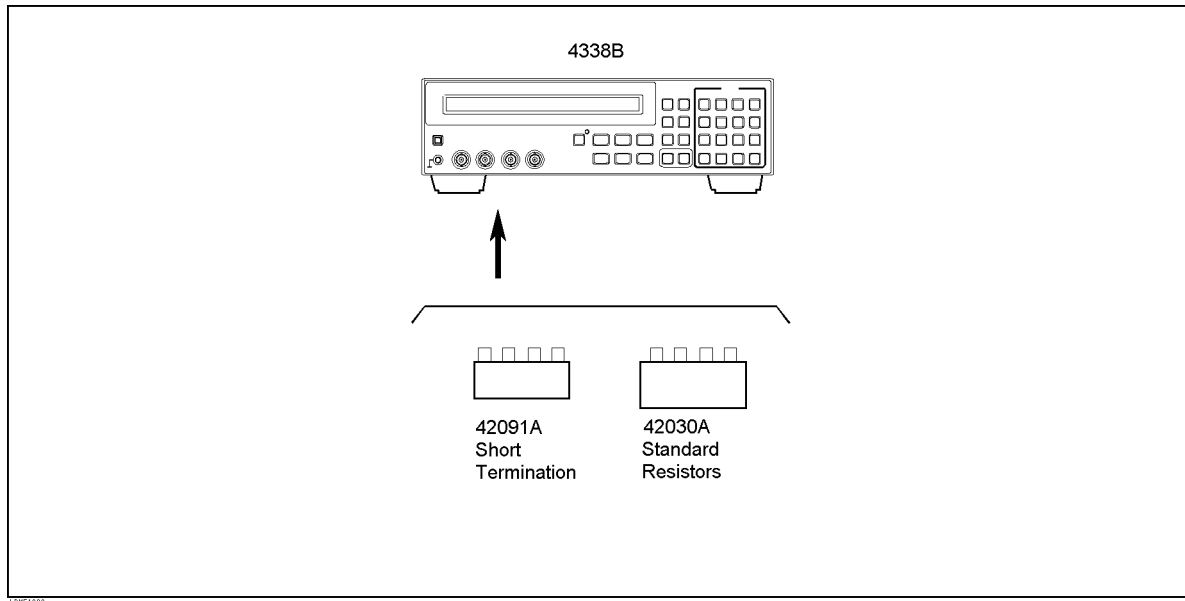

**Figure 9-2. Resistance Measurement Accuracy Test Setup**

4. Perform the SHORT correction using the following procedure.
  - a. Press to display the SHORT correction menu.
  - b. Press or until **ShortMeas** blinks, and press .
  - c. Press or until **Exit** blinks, and press .
5. Press to set the trigger mode to Manual. The **Trigger** annunciator(▼) indicates “Man”.
6. Press to set the measurement time to Long. The **Meas Time** annunciator(▼) indicates “Long”.
7. Connect the 1 mΩ Standard Resistor to the 4338B’s UNKNOWN terminals.
8. Set the test signal level to 10 mA using the following procedure.
  - a. Press to display the test signal level setting menu.
  - b. Press or until 10 mA blinks, and press .
9. Press to measure.
10. Record the 4338B reading of R on the calculation sheet.
11. Calculate the test result according to the calculation sheet, and record the result into the performance test record.
12. Perform this test for all standards and level settings listed in Table 9-2. The test signal level must be changed after the standard resistor is connected.

Table 9-2. Resistance Measurement Accuracy Test Settings

Standard	Test Signal Level
1 m $\Omega$	10 mA
10 m $\Omega$	10 mA
100 m $\Omega$	1 mA
1 $\Omega$	10 mA
10 $\Omega$	10 $\mu$ A
100 $\Omega$	1 $\mu$ A
1 k $\Omega$	10 $\mu$ A
10 k $\Omega$	1 $\mu$ A

Calculation Sheet

Test Signal Frequency Accuracy Test

<b>Counter Reading</b> <b>[a]</b>	<b>Test Result</b> <b>Equation</b>
_____ kHz	$a - 1.00000 \text{ kHz}$

Resistance Measurement Accuracy Test

Standard	Test Signal	Standard Calibration	4338B Reading	Test Result
	Current	Value [a]	[b]	Equation
1 mΩ	10 mA	_____ mΩ	_____ mΩ	$b - a$
10 mΩ	10 mA	_____ mΩ	_____ mΩ	$b - a$
100 mΩ	1 mA	_____ mΩ	_____ mΩ	$b - a$
1 Ω	10 mA	_____ Ω	_____ Ω	$b - a$
10 Ω	10 μA	_____ Ω	_____ Ω	$b - a$
100 Ω	1 μA	_____ Ω	_____ Ω	$b - a$
1 kΩ	10 μA	_____ kΩ	_____ kΩ	$b - a$
10 kΩ	1 μA	_____ kΩ	_____ kΩ	$b - a$

**Performance Test Record**

Agilent 4338B Milliohmmeter

Serial No.: \_\_\_\_\_

Date: \_\_\_\_\_

Temperature: \_\_\_\_\_

Tested by: \_\_\_\_\_

Humidity: \_\_\_\_\_

**Test Signal Frequency Accuracy Test**

Test Signal Frequency	Test Limits	Test Result <sup>1</sup>	Measurement Uncertainty
1 kHz	±0.0010 kHz	_____ kHz	± 0.0000088 kHz

<sup>1</sup> Test Result = Measured Value – Typical Value of 1 kHz

**Resistance Measurement Accuracy Test**

Standard	Test Signal Current	Test Limits	Test Result <sup>1</sup>	Measurement Uncertainty
1 mΩ	10 mA	±0.024 mΩ	_____ mΩ	±0.001 mΩ
10 mΩ	10 mA	±0.054 mΩ	_____ mΩ	±0.010 mΩ
100 mΩ	1 mA	±0.45 mΩ	_____ mΩ	±0.10 mΩ
1 Ω	10 mA	±0.0043 Ω	_____ Ω	±0.0010 Ω
10 Ω	10 μA	±0.044 Ω	_____ Ω	±0.003 Ω
100 Ω	1 μA	±0.49 Ω	_____ Ω	±0.021 Ω
1 kΩ	10 μA	±0.0093 kΩ	_____ kΩ	±0.00021 kΩ
10 kΩ	1 μA	±0.54 kΩ	_____ kΩ	±0.0021 kΩ

<sup>1</sup> Test Result = Measured Value – Standard's Calibration Value

## Functional Test

### Introduction

This section provides the test procedures used to verify that the 4338B performs its designed functions. The functional tests can be used for post repair function verification. The test signal level functional test is recommended to be performed during the 4338B performance testing. Record the test signal level functional test result in the test record at the end of this section.

### Test Equipment

Table 9-1 lists the test equipment required to perform the tests described in this section. Equipment which equals or surpasses the key required specifications of the recommended equipment may be used.







### Test Signal Level Functional Test

The 4338B's signal source output voltage is measured with an AC voltmeter.

#### Test Equipment

Description	Recommended Model
Multimeter	3458A
30 cm BNC(m)-BNC(m) Cable	PN 8120-1838
61 cm BNC(m)-BNC(m) Cable	PN 8120-1839
Dual Banana-BNC(f) Adapter	PN 1251-2277

#### Procedure

1. Reset the 4338B with the following procedure.
  - a. Press   to display the system reset menu.
  - b. Press  or  until Yes blinks, and press .
2. Set up the equipment as shown in Figure 9-3.

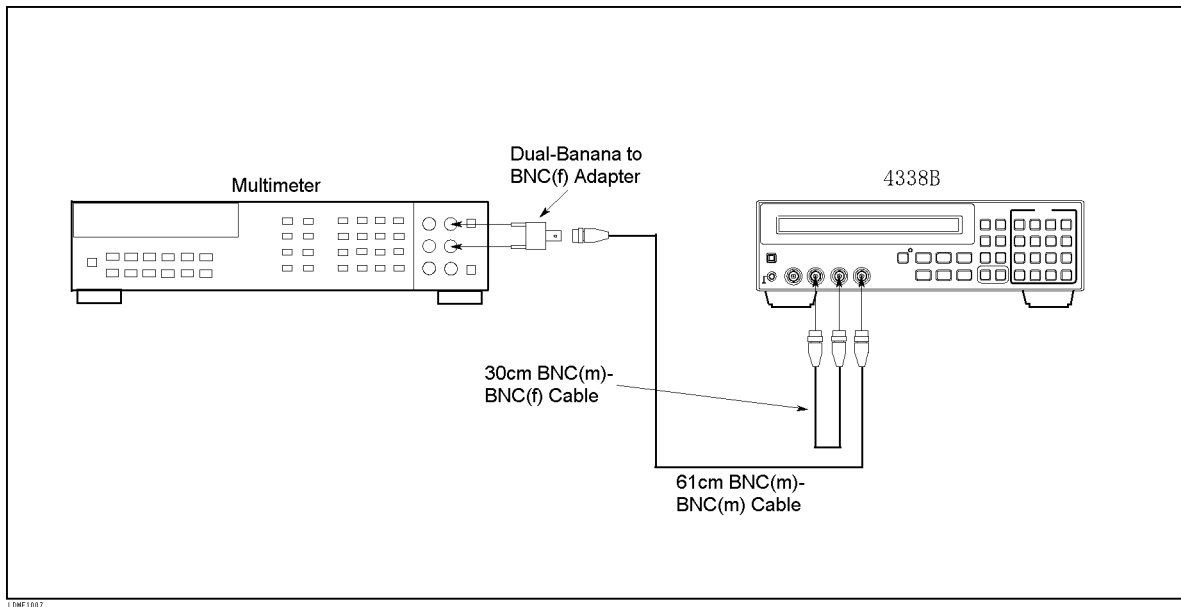



























Figure 9-3. Test Signal Level Functional Test Setup

3. Set the 3458A Multimeter to Synchronously Sub-sample AC voltage measurement mode using the following procedure:
  - a. Press  to set the measurement mode to AC voltage.
  - b. Press      to display *SETACV*.
  - c. Press     to display *SYNC*, then press .
4. Set the test signal level to 1 mA using the following procedure.
  - a. Press  to display the test signal level setting menu.

- b. Press  or  until 1 mA blinks, and press .
- 5. Set the trigger delay time to 9 seconds using the following procedure.
  - a. Press   to display the trigger/source delay setting menu.
  - b. Press  or  until TrigDelay blinks, and press .
  - c. Press , and press .
  - d. Press  or  until Exit blinks, and press .
- 6. Confirm that the multimeter reading is within the test limits listed in Table 9-3.

**Note**



The multimeter may display strange voltage readings for a moment in this test, this is because the 4338B turns the test signal off after each measurement. The delay time, in which the 4338B outputs the test signal continuously, is used to ease the test signal level measurement.

- 7. Perform this test for all settings listed in Table 9-3

**Table 9-3.**

Test Signal Level	Minimum Limit	Maximum Limit
1 mA	9.9 mV	12.1 mV
10 mA	99 mV	121 mV

### Handler Interface Functional Test

The 4338B's handler interface function is tested using the built-in selftest and the handler interface tester.

#### Test Equipment

Description	Recommended Model
Handler Interface Tester	04339-65007

#### Procedure

##### Initial Setup.

1. Turn the 4338B OFF.
2. Set the LED\_PW switch on the Handler Interface Tester to *OFF*, and set the IN1, IN2, IN3, and IN4 switches to *0*.
3. Set up the equipment as shown in Figure 9-4

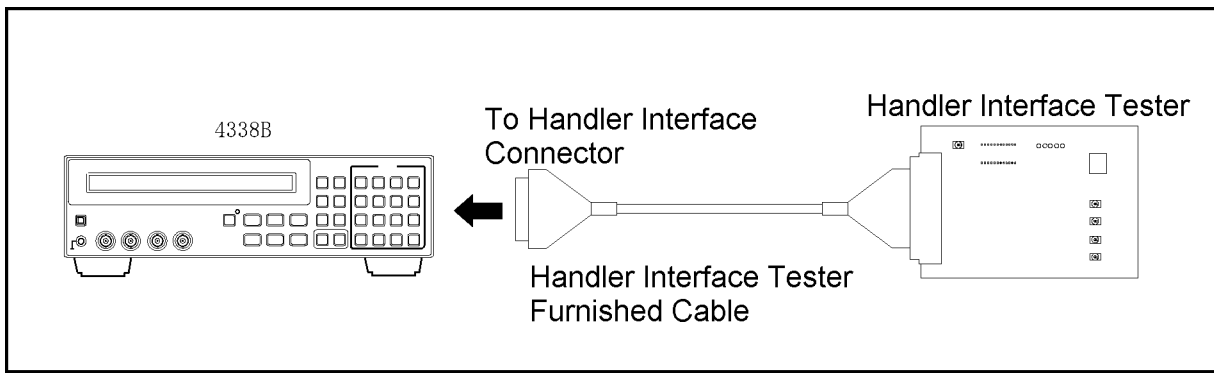







Figure 9-4. Handler Interface Functional Test Setup

4. Turn the 4338B ON.
5. Reset the 4338B using the following procedure.
  - a. Press   to display the system reset menu.
  - b. Press  or  until Yes blinks, and press .

##### Key Lock Function Test.









6. Set the *IN4* switch on the Handler Interface Tester to *1*.
7. Confirm that the all keys on the 4338B's front panel are locked out.
8. Set the *IN4* switch on the Handler Interface Tester to *0*.

##### External Trigger Function Test.

9. Press  to set the trigger mode to External.
10. Press the *IN5* switch on the Handler Interface Tester, and confirm that the 4338B is triggered.

**Handler Interface Output Test.**

11. Start the handler interface output test with the following procedure.

- a. Press   to display the configuration setting menu.
- b. Press  or  until Svc blinks, and press .
- c. Press  or  until HNDL blinks, and press .

12. Set the *LED\_PW* switch on the Handler Interface Tester to *ON*.

**Caution**



Do not set the *LED\_PW* switch to *ON*, except when doing the handler interface output test. The LEDs may cause the 4338B to shut-down during normal operation.

13. Confirm that the LEDs on the Handler Interface Tester light in the order shown in Figure 9-5, in accordance with the 4338B display.

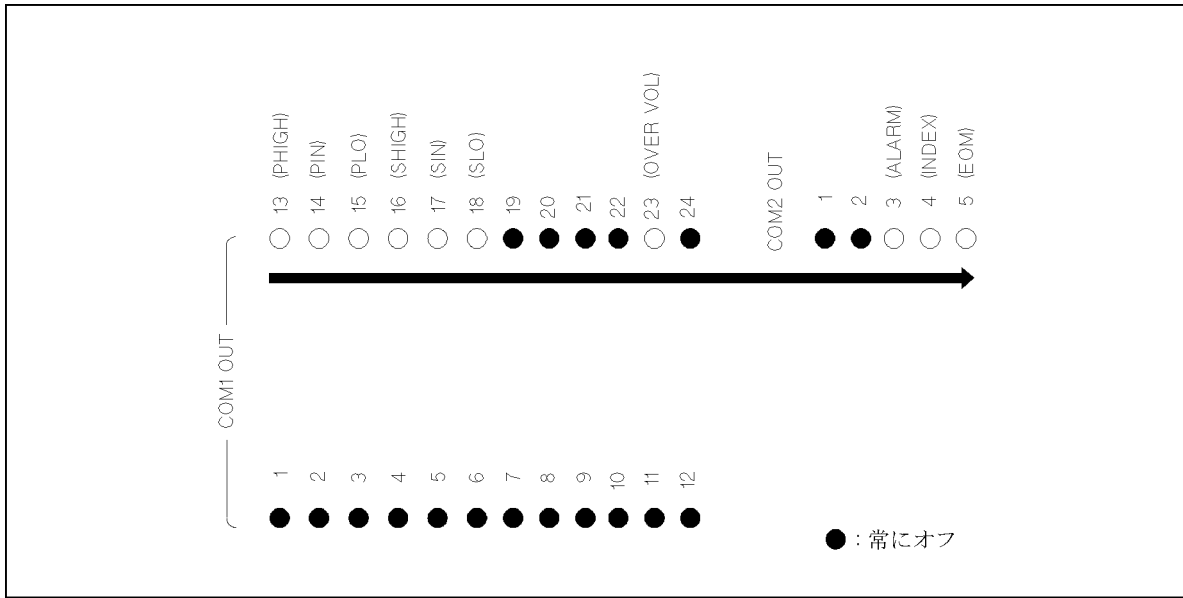

**Figure 9-5. Handler interface Output Order**

14. Set the *LED\_PW* switch on the Handler Interface Tester to OFF.

15. Press  twice to exit from the test mode.

### Functional Test Record

Agilent 4338B Milliohmmeter

#### Test Signal Level Functional Test

Serial No.: \_\_\_\_\_

Date: \_\_\_\_\_

Temperature: \_\_\_\_\_

Tested by: \_\_\_\_\_

Humidity: \_\_\_\_\_

**Pass**

**Fail**

[ ]

[ ]

## Manual Changes

---

### Introduction

This appendix contains the information required to adapt this manual to earlier versions or configurations of the 4338B than the current printing date of this manual. The information in this manual applies directly to the 4338B serial number prefix listed on the title page of this manual.

### Manual Changes

To adapt this manual to your 4338B, see Table A-1 and Table A-2, and make all the manual changes listed opposite your instrument's serial number and firmware version.

Instruments manufactured after the printing of this manual may be different from those documented in this manual. Later instrument versions will be documented in a manual changes supplement that will accompany the manual shipped with that instrument. If your instrument's serial number or ROM version is not listed on the title page of this manual, in Table A-1, or Table A-2, make changes according to the *yellow MANUAL CHANGES* supplement.

In additions to information on changes, the supplement may contain information for correcting errors (Errata) in the manual. To keep this manual as current and accurate as possible, Agilent Technologies recommends that you periodically request the latest *MANUAL CHANGES* supplement.

For information concerning serial number prefixes not listed on the title page or in the *MANUAL CHANGE* supplement, contact the nearest Agilent Technologies office.

To confirm the firmware version, turn ON the power for the 4338B or execute \*IDN? on the external controller.

**Table A-1. Manual Changes by Serial Number**

Serial Prefix or Number	Make Manual Changes

**Table A-2. Manual Changes by ROM Version**

Version	Make Manual Changes
1.00	Change 1

**Change 1**

When the “OVLD”, “OVVOL” or “N.C.” is displayed during the SHORT correction, the 4338B will display, “WARNING: Out Of Limit”. The SHORT correction data will still be used.

## Serial Number

Agilent Technologies uses a two-part, ten-character serial number that is stamped on the serial number plate (see Figure A-1) attached to the rear panel. The first five characters are the serial prefix and the last five digits are the suffix.



**Figure A-1. Serial Number Plate**





# Handler Interface Installation

---

## Introduction

This appendix provides a description of the electrical characteristics of the interface signals.

---

## Electrical Characteristics

### Output Signals

Each DC output is isolated using open collector output opto-isolators. The output voltage of each line is set by pull-up resistors on the main board. The pull-up resistors are connected to an externally applied dc voltage.

The electrical circuits of the dc isolated outputs are divided into two types (See Table B-1).

A simplified diagram of the output signals is shown in Figure B-1 for comparison signals and Figure B-2 for control signals.

**Table B-1. Handler Output Electrical Characteristics**

Output Signals	Voltage Output Rating		Maximum Current	External Voltage/ Circuit Common
	Low	High		
<b>Comparison Signals</b> /PHI, /PIN, /PLO /SHI, /SIN, /SLO /OVVOL (or N.C)	≤ 0.5 V	5 to 24 V	6 mA	EXT DCV1 COM1
<b>Control Signals</b> /ALARM /INDEX /EOM	≤ 0.5 V	5 to 15 V	5 mA	EXT DCV2 COM2

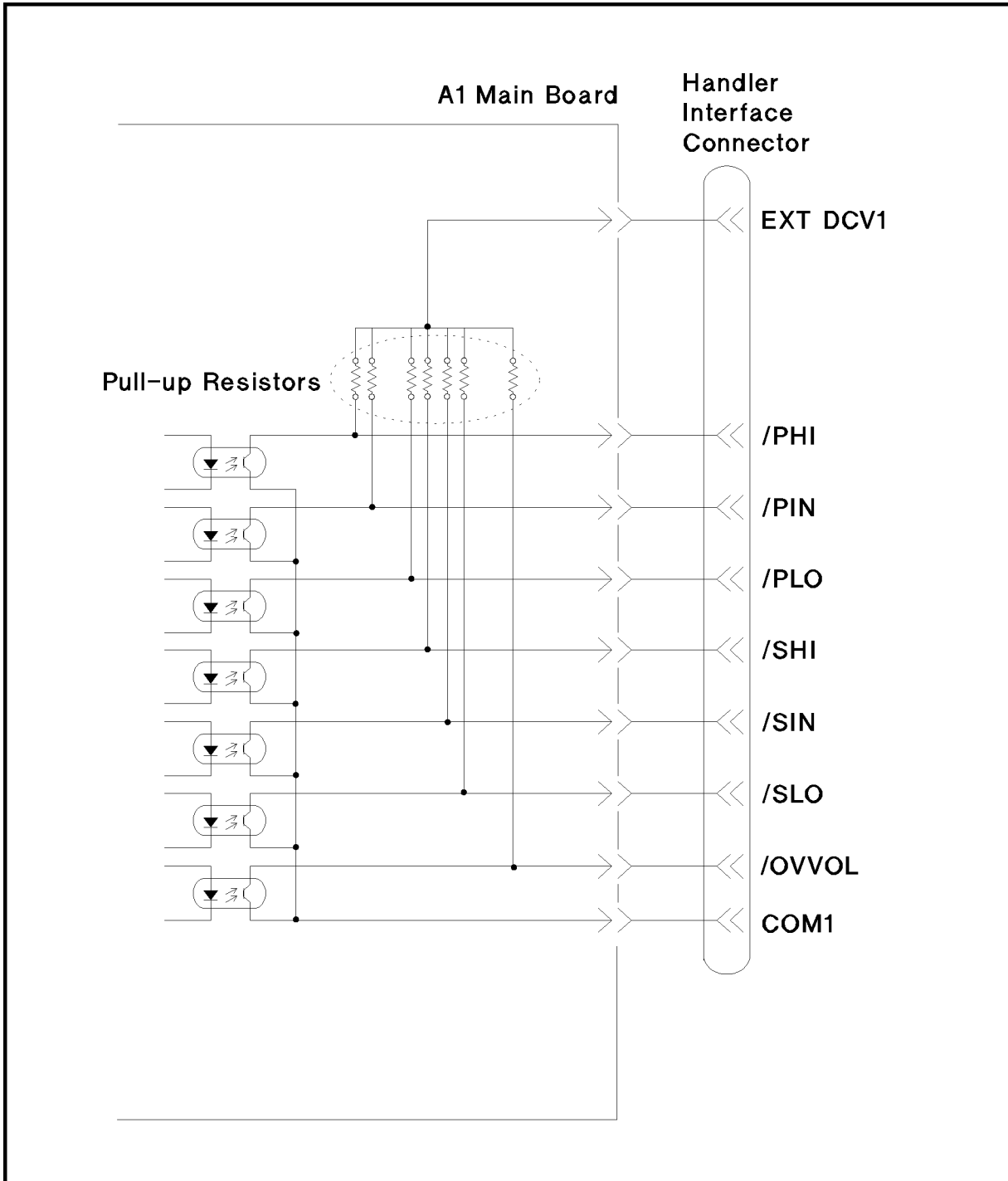

LD0EB001

Figure B-1. Handler Interface Comparison Output Signals Diagram

B-2 Handler Interface Installation

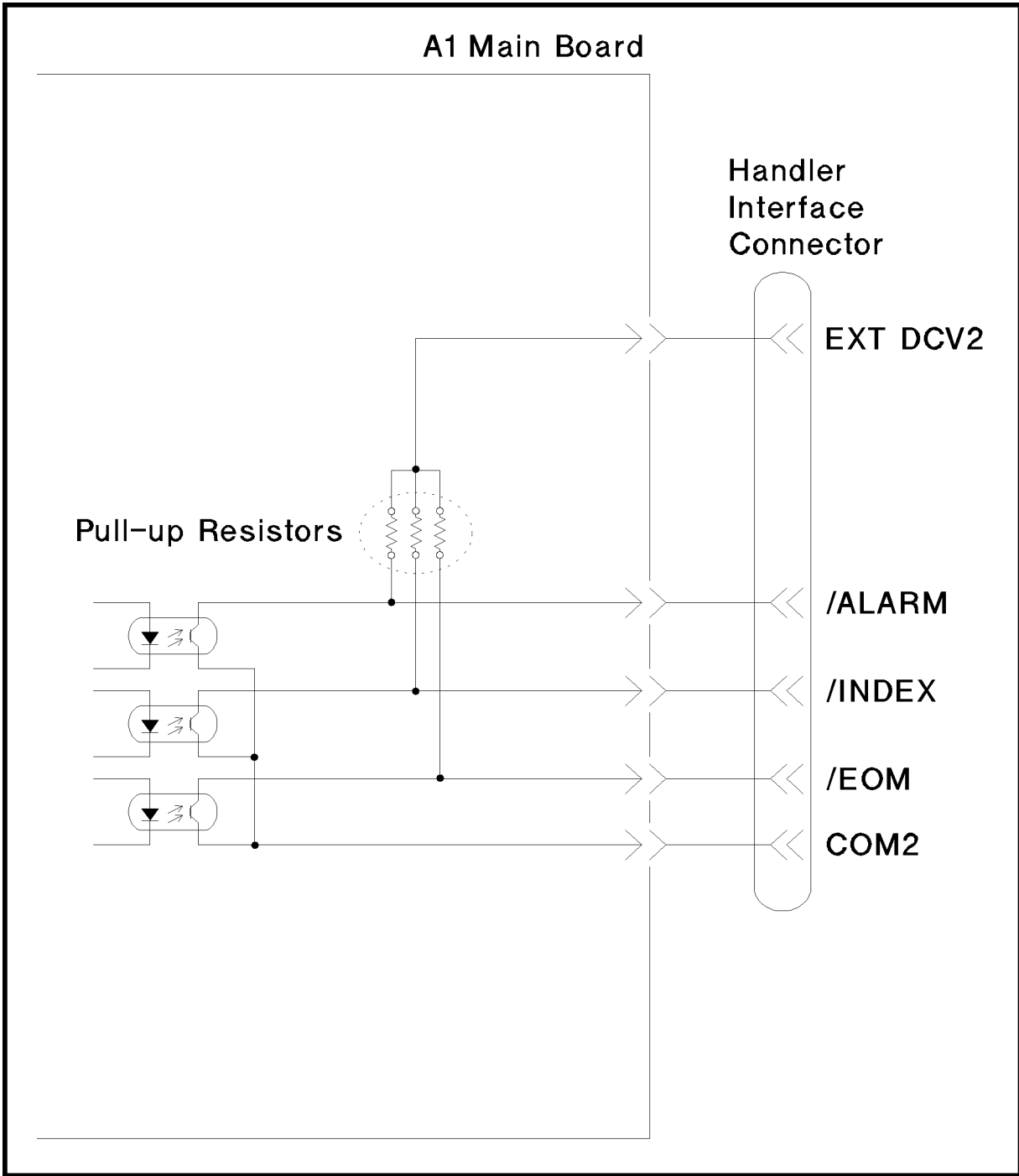

L600B003

Figure B-2. Handler Interface Control Output Signals Diagram

**Input Signals**

The dc isolated input signals are connected to the cathodes of the LEDs in the opto-isolators. The anodes of the LEDs are powered by an external voltage source (EXT DCV2).

The OFF state voltage (high level) of the dc isolated input signals depends on the pull-up voltage selected by a switch on the main board.

The electrical characteristics of the signals are listed in Table B-2. A diagram for the input signals is shown in Figure B-3.

**Table B-2. Handler Input Electrical Characteristics**

Signal	Input Voltage		Input Current (Low) Pull-up Voltage			Circuit Common
	Low	High	5 V	12 V	15 V	
/EXT TRIG	≤ 1 V	5 to 15 V	8.7 mA	10.5 mA	13.5 mA	COM2
/KEY LOCK	≤ 1 V	5 to 15 V	7.7 mA	10.8 mA	13.6 mA	COM2

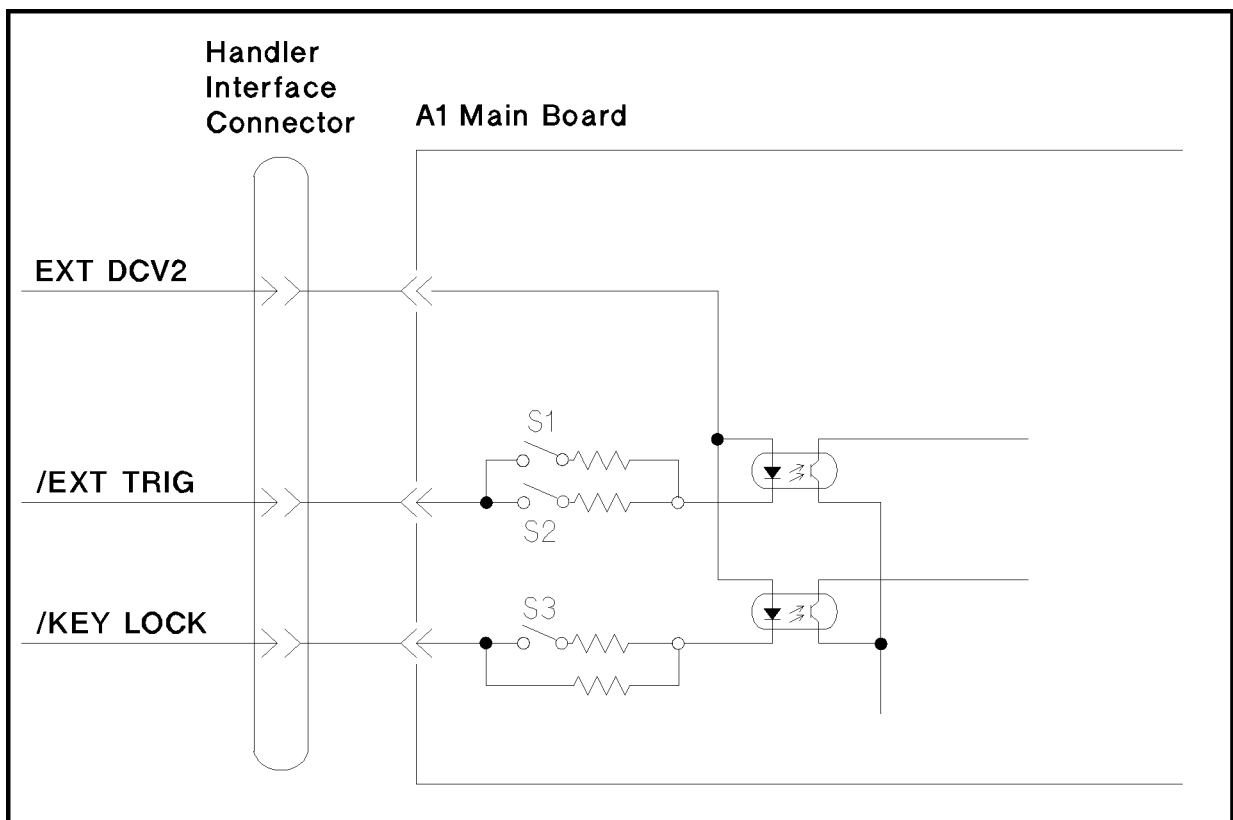

**Figure B-3. Handler Interface Input Signal Diagram**

---

## Setting Up the Handler Interface Board

Before using the handler interface, connect the pull-up resistors to enable the output signals and set the dip switch to select the voltage level for the input signals.

---

**Caution**      SUSCEPTIBLE TO DAMAGE FROM ESD.



Perform the following procedures only at a static-safe workstation and wear a grounding strap.

---

---

## Tools and Fasteners

The 4338B mechanical components are secured using metric threaded fasteners. Many fasteners in the 4338B may appear to be Phillips type, but they are Pozidrive type fasteners. To avoid damaging them, use only Pozidrive screwdrivers to remove or tighten Pozidrive type fasteners.

### Procedure

1. Disconnect the power cable from the 4338B and allow enough time (10 minutes) for the internal capacitors to discharge.

---

**Warning**      **Dangerous energy and voltage levels exist within the 4338B when it is in operation and just after it is powered down. Allow 10 minutes for the 4338B's internal capacitors to discharge before starting to work on it.**



2. Remove the two screws which fasten the cover to the chassis rear panel.
3. Slide the cover toward the rear while holding the front panel bezel.

The following figure shows the location of the A1 main board and the A2 CPU board.

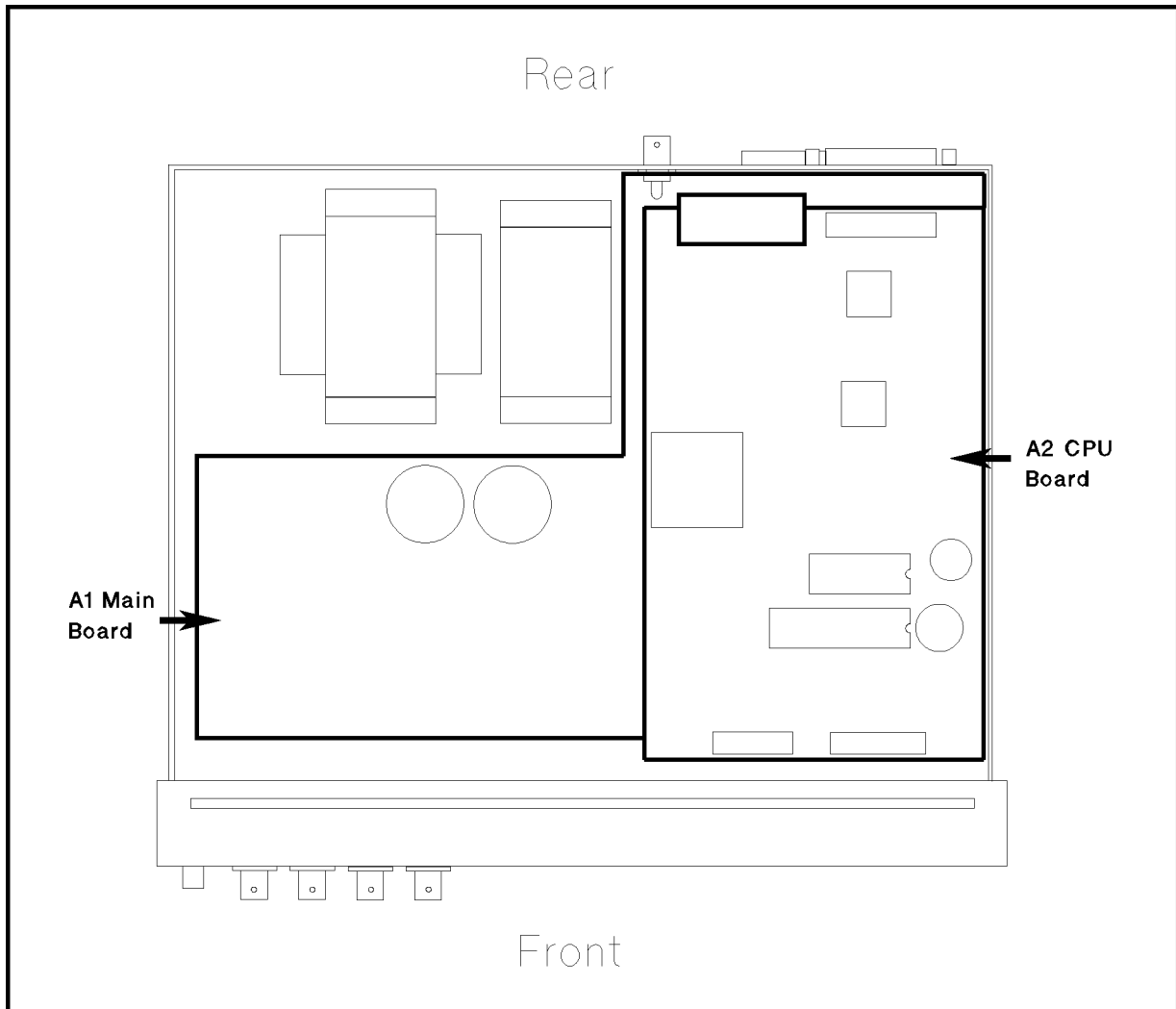

L700B005

4. Remove the A2 CPU board assembly.
  - a. Disconnect two flat cables which connect the A2 board to the keyboard assembly and the LCD assembly.
  - b. Remove the four screws that secure the A2 board to the stud.
  - c. Slide the A2 board toward front to disconnect the flat cable which connect the A2 assembly to the A1 main board on the bottom.
  - d. Remove the A2 board from the chassis.
5. Remove the A1 main board assembly.
  - a. Disconnect the following cable assemblies from the A1 board.
    - i. Four cables which are connected to the UNKNOWN connectors on the Front Panel.
    - ii. The cable assembly from the transformer.
    - iii. Two cable assemblies from the dc-dc converter.

- b. Remove the four studs, that secure the A1 board to the chassis, by rotating them using a flat blade screwdriver.
- c. Remove the screws that secure the A1 board to the chassis.
- d. Remove the A1 board from the chassis.

Figure B-4 shows the location of the socket for the pull-up resistors (J5) and the switch for EXT DCV2 voltage setting (SW1). Table B-3 lists the location of the pull-up resistors.

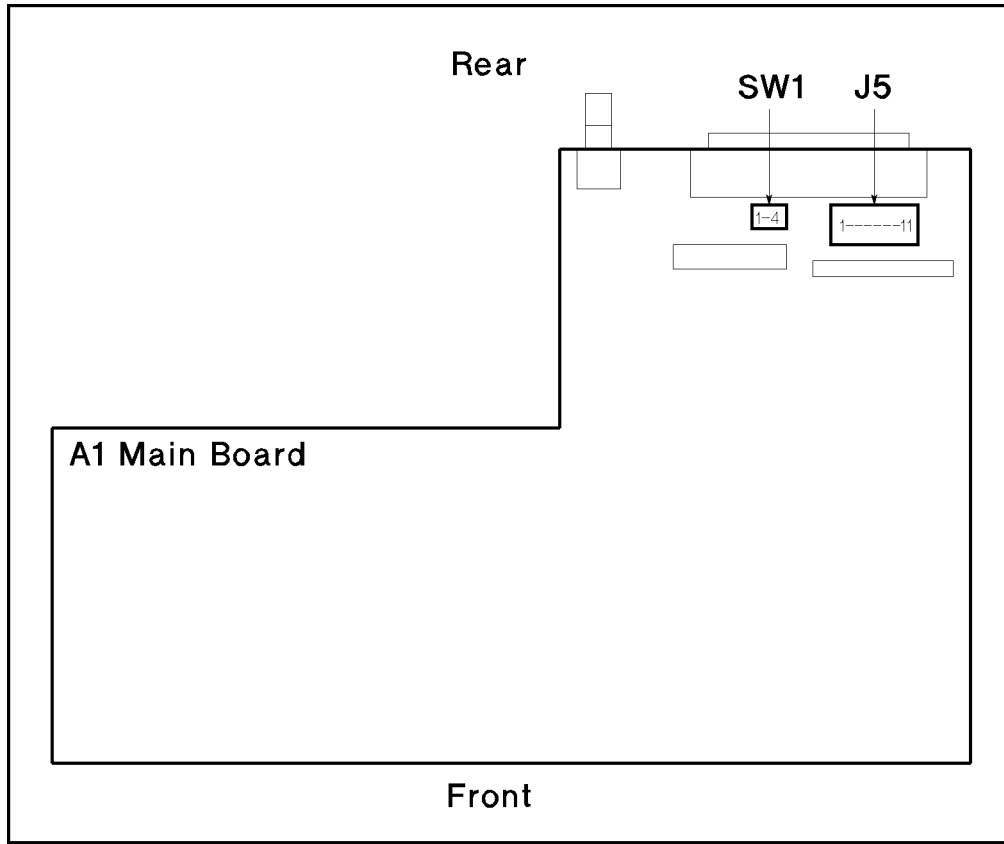

Figure B-4. A1 Main Board Location



**Table B-3. Pull-up Resistor Locations**

Socket No.	Signal Name	Signal Type
J5-1	/EOM	Control Signal (5 to 15 V)
J5-2	/INDEX	
J5-3	/PIN	Comparison Signal (5 to 24 V)
J5-4	/PHI	
J5-5	/PLO	
J5-6	/SIN	
J5-7	/SHI	
J5-8	/SLO	
J5-9	/OVVOL	
J5-10	/ALARM	Control Signal (5 to 15 V)
J5-11	Not used	

6. Mount the pull-up resistors for the comparison output signals. (Refer to Figure B-4 and Table B-3 for the location of the pull-up resistors for the comparison output signals.) Use the following equation to determine the value of the pull-up resistors (R).

$$R \text{ [k}\Omega\text{]} \simeq V_p \text{ [V]} / 3$$

where,  $V_p$  is the pull-up voltage.

The typical pull-up resistor values are:

Pull-up Voltage	Pull-up Resistor Agilent Part Number
5 V	0757-0278 (1.78 k $\Omega$ )
12 V	0757-0279 (3.16 k $\Omega$ )
24 V	0757-0441 (8.25 k $\Omega$ )

7. Mount the pull-up resistors for the control output signals. (Refer to Figure B-4 and Table B-3 for the location of the pull-up resistors for the control output signals.) Use the following equation to determine the value of the pull-up resistors (R).

$$R \text{ [k}\Omega\text{]} \simeq V_p \text{ [V]} / 2.5$$

where,  $V_p$  is the pull-up voltage.

**4338B**

The typical pull-up resistor values are:

<b>Pull-up Voltage</b>	<b>Pull-up Resistor Agilent Part Number</b>
5 V	0757-0278 (1.78 kΩ)
9 V	0757-0279 (3.16 kΩ)
12 V	0698-3154 (4.22 kΩ)
15 V	0757-0438 (5.11 kΩ)

8. Set the SW1 according to the voltage value of EXT DCV2.

<b>EXT DCV2</b>	<b>EXT TRIG</b>		<b>KEY LOCK</b>
	<b>SW1-1</b>	<b>SW1-2</b>	<b>SW1-3</b>
5 to 6 V	Close	Close	Close
6 to 9 V	Close	Open	Close
9 to 15 V	Open	Close	Open

9. Reinstall the A1 main board, the A2 CPU board, and the cover.



## Overload/Over-Voltage/No-Contact Operations

Table C-1 shows the summary of operations, when the 4338B detects OVLD (Overload), OVVOL (Over-Voltage) or N.C. (No-Contact).

**Table C-1. OVLD/OVVOL/N.C. Condition**

Condition	Display		Handler Output	GPIB Output <sup>1</sup>	Solutions
	Data Mode	Comprtr Mode			
OVLD (Overload)	OVLD	High	/PHI and /SHI	<State> <sup>2</sup> :1 <Data> :9.9999E13 <Comp> <sup>3</sup> :2	Select an appropriate measurement range.
OVVOL (Over-Voltage)	OVVOL	High	/PHI and /SHI and /OVVOL or /N.C.	<State> <sup>2</sup> :4 <Data> :9.9999E13 <Comp> <sup>3</sup> :2	Change to the appropriate signal level.
N.C. (No-Contact)	N.C.	N.C.	/OVVOL or /N.C.	<State> <sup>2</sup> :2 <Data> :9.9999E13 <Comp> <sup>3</sup> :8	Cancel the bad contact between the DUT and the contact-pin.

1. Refer to the :FETCh? Command in Chapter 5.
2. Measurement Status : (0 : Normal, 1 : Overload, 2 : No-Contact, 4 : Over-Voltage)
3. Comparison result : (1 : IN, 2 : HIGH, 4 : LOW, 8 : No-Contact)
4. /OVVOL signal or /N.C. signal is detected from the Pin No.38 in the 4338B Handler Interface.

### Caution



When the measurement parameter R is selected, GPIB output and Handler Interface output are following.

GPIB output : <Comp2> : 0

Handler output : /SHI signal isn't detected.

Table C-2 shows the summary of operations, when the 4338B detects OVLD (Overload), OVVOL (Over-Voltage) or N.C. (No-Contact).

The 4338B performs one of following cases in the Table C-2.

**Table C-2. Combination of any two OVLD/OVVOL/N.C. Conditions**

Condition	Display		Handler Output	GPIB Output <sup>1</sup>	Solutions
	Data Mode	Comprtr Mode			
OVLD & N.C.	N.C.	N.C.	/OVVOL or /N.C.	<State> <sup>2</sup> :2 <Data> :9.9999E13 <Comp> <sup>3</sup> :8	Select an appropriate measurement range. Cancel the bad contact between the DUT and the contact-pin.
OVLD & OVVOL	OVVOL	High	/PHI and /SHI or /OVVOL or /N.C.	<State> <sup>2</sup> :4 <Data> :9.9999E13 <Comp> <sup>3</sup> :2	Select an appropriate measurement range. Change to the appropriate signal level.
N.C. & OVVOL	N.C.	N.C.	/OVVOL or /N.C.	<State> <sup>2</sup> :2 <Data> :9.9999E13 <Comp> <sup>3</sup> :8	Change to the appropriate signal level. Cancel the bad contact between the DUT and the contact-pin.
	OVVOL	High	/PHI and /SHI and /OVVOL or /N.C.	<State> <sup>2</sup> :4 <Data> :9.9999E13 <Comp> <sup>3</sup> :2	

1. Refer to the :FETCh? Command in Chapter 5.
2. Measurement Status : (0 : Normal, 1 : Overload, 2 : No-Contact, 4 : Over-Voltage)
3. Comparison result : (1 : IN, 2 : HIGH, 4 : LOW, 8 : No-Contact)
4. /OVVOL signal or /N.C. signal is detected from the Pin No.38 in the 4338B Handler Interface.

**Caution**



When the measurement parameter R is selected, GPIB output and Handler Interface output are following.

GPIB output : <Comp2> : 0

Handler output : /SHI signal isn't detected.

Table C-3 shows the summary of operations, when the 4338B detects OVLD (Overload), OVVOL (Over-Voltage) and N.C. (No-Contact) simultaneously.  
 The 4338B performs one of following cases in the Table C-3.

**Table C-3. Simultaneous OVLD/OVVOL/N.C. Condition**

Condition	Display		Handler Output	GPIB Output <sup>1</sup>	Solutions
	Data Mode	Comprtr Mode			
OVLD & OVVOL & N.C.	N.C.	N.C.	/OVVOL or /N.C.	<State> <sup>2</sup> :2 <Data> :9.9999E13 <Comp> <sup>3</sup> :8	Select an appropriate measurement range.Change to the appropriate signal level. Cancel the bad contact between the DUT and the contact-pin.
	OVVOL	High	/PHI and /SHI or /OVVOL or /N.C.	<State> <sup>2</sup> :4 <Data> :9.9999E13 <Comp> <sup>3</sup> :2	

1. Refer to the :FETCh? Command in Chapter 5.
2. Measurement Status : (0 : Normal, 1 : Overload, 2 : No-Contact, 4 : Over-Voltage)
3. Comparison result : (1 : IN, 2 : HIGH, 4 : LOW, 8 : No-Contact)
4. /OVVOL signal or /N.C. signal is detected from the Pin No.38 in the 4338B Handler Interface.

**Caution**



When the measurement parameter R is selected, GPIB output and Handler Interface output are following.  
 GPIB output : <Comp2> : 0  
 Handler output : /SHI signal isn't detected.



# **Error Messages**

---

This section lists the error messages that are displayed on the 4338B's LCD display or transmitted by the instrument over GPIB in numerical order.



## Instrument Errors

### 11 **ADC FAILURE**

The AD converter failed. Contact your nearest Agilent Technologies office.

### 12 **ROM TEST FAILED**

Contact your nearest Agilent Technologies office.

### 13 **RAM TEST FAILED**

Contact your nearest Agilent Technologies office.

### 14 **EEPROM R/W FAILED**

Contact your nearest Agilent Technologies office.

### 15 **USER DATA LOST**

Correction data and instrument settings saved in EEPROM have been lost. Contact your nearest Agilent Technologies office.

### 16 **PREV. SETTING LOST**

Instrument settings in the backup memory have been lost. The instrument keeps instrument settings in backup memory for 72 hours after being turned OFF.

### 17 **SAVE FAILED**

Contact your nearest Agilent Technologies office.

### 18 **RECALL FAILED**

No instrument setting saved in the EEPROM.

### 19 **PRINTER NO RESPONSE**

Something is wrong, check the following items:

- Check that the power code is connected to your printer.
- Check that the GPIB cable is connected between the printer and the instrument.
- Check that the printer is set to "Listen Always."

### 20 **A1 BD TEST FAILED**

The A1 board failed. Contact your nearest Agilent Technologies office.

### 21 **LOCKOUT BY HANDLER**

Front panel key input is disabled by the handler. The front panel key input cannot be enabled by the front panel keys or by GPIB commands when disabled by the handler.

---

## GPIB Errors

### -100 **Command error**

This is a generic syntax error that the 4338B cannot detect more specific errors. This code indicates only that a command error, as defined in IEEE 488.2, 11.5.1.1.4, has occurred.

### -101 **Invalid character**

A syntax element contains a character which is invalid for that type; for example, a header containing an ampersand, SENSE&.

### -102 **Syntax error**

An unrecognized command or data type was encountered; for example, a string was received when the 4338B was not expecting to receive a string.

### -103 **Invalid separator**

The syntax analyzer was expecting a separator and encountered an illegal character; for example, the semicolon was omitted after a program message unit, \*RST:TRIG.

### -104 **Data type error**

The syntax analyzer recognized an unallowed data element; for example, numeric or string data was expected but block data was encountered.

### -105 **GET not allowed**

A Group Execute Trigger (GET) was received within a program message (see IEEE 488.2, 7.7).

### -108 **Parameter not allowed**

More parameters were received than expected for the header; for example, the [:SENSe]:AVERage:COUNt command only accepts one parameter, so receiving :AVER:COUN 2,4 is not allowed.

### -109 **Missing parameter**

Fewer parameters were received than required for the header; for example, the [:SENSe]:AVERage:COUNt command requires one parameter, so receiving only :AVER:COUN is not allowed.

### -112 **Program mnemonic too long**

The header contains more than twelve characters (see IEEE 488.2, 7.6.1.4.1).

### -113 **Undefined header**

The header is syntactically correct, but it is undefined for the 4338B; for example, \*XYZ is not defined for the 4338B.

### -121 **Invalid character in number**

An invalid character for the data type being parsed was encountered; for example, an alpha character in a decimal numeric or a “9” in octal data.

**-123 Numeric Overflow**

The magnitude of the exponent was larger than 32000 (see IEEE 488.2, 7.7.2.4.1).

**-124 Too many digits**

The mantissa of a decimal numeric data element contains more than 255 digits excluding leading zeros (see IEEE 488.2, 7.7.2.4.1).

**-128 Numeric data not allowed**

Legal numeric data element was received, but the 4338B does not accept it in this position for a header.

**-131 Invalid suffix**

The suffix does not follow the syntax described in IEEE 488.2, 7.7.3.2, or the suffix is inappropriate for the 4338B.

**-138 Suffix not allowed**

A suffix was encountered after a numeric element which does not allow suffixes.

**-140 Character data error**

This error, as well as errors –141 through –148, are generated when analyzing the syntax of a character data element. This particular error message is used if the 4338B cannot detect a more specific error.

**-141 Invalid character data**

Either the character data element contains an invalid character or the particular element received is not valid for the header.

**-144 Character data too long**

The character data element contains more than twelve characters (see IEEE 488.2, 7.7.1.4).

**-148 Character data not allowed**

A legal character data element was encountered that's prohibited by the 4338B.

**-150 String data error**

This error, as well as errors –151 and –158, are generated when analyzing the syntax of a string data element. This particular error message is used if the 4338B cannot detect a more specific error.

**-151 Invalid string data**

A string data element was expected, but was invalid for some reason (see IEEE 488.2, 7.7.5.2); for example, an END message was received before the terminal quote character.

**-158 String data not allowed**

A string data element was encountered but was not allowed by the 4338B at this point in the syntax analysis process.

**-160 Block data error**

This error, as well as errors –161 and –168, are generated when analyzing the syntax of a block data element. This particular error message is used if the 4338B cannot detect a more specific error.

**-161 Invalid block data**

A block data element was expected, but was invalid for some reason (see IEEE 488.2, 7.7.6.2); for example, an END message was received before the length was satisfied.

**-168 Block data not allowed**

A legal block data element was encountered but was not allowed by the 4338B at this point in the syntax analysis process.

**-170 Expression error**

This error, as well as errors –171 and –178, are generated when analyzing the syntax of an expression data element. This particular error message is used if the 4338B cannot detect a more specific error.

**-171 Invalid expression**

The expression data element was invalid (see IEEE 488.2, 7.7.7.2); for example, unmatched parentheses or an illegal character.

**-178 Expression data not allowed**

A legal expression data was encountered but was not allowed by the 4338B at this point in the syntax analysis process.

**-200 Execution errors**

This is the generic syntax error that the 4338B cannot detect more specific errors. This code indicates only that an execution error as defined in IEEE 488.2, 11.5.1.1.5 has occurred.

**-211 Trigger ignored**

A GET, \*TRG, or triggering signal was received and recognized by the 4338B but was ignored because of 4338B timing considerations; for example, the 4338B was not ready to respond.

**-213 Init ignored**

A request for a measurement initiation was ignored as another measurement was already in progress.

**-221 Settings conflict**

A legal program data element was analyzed syntax but could not be executed due to the current device state (see IEEE 488.2, 6.4.5.3 and 11.5.1.1.5).

**-222 Data out of range**

A legal program data element was analyzed syntax but could not be executed because the interpreted value was outside the legal range as defined by the 4338B (see IEEE 488.2, 11.5.1.1.5).

**-223 Too much data**

A legal program data element of block, expression, or string type was received that contained more data than the 4338B could handle due to memory or related device-specific requirements.

**-230 Data corrupt or stale**

Possibly invalid data; new reading started but not completed since last access.

**-241 Hardware missing**

A legal program command or query could not be executed because of missing 4338B hardware; for example, an option was not installed.

**-310 System error**

Some error, termed "system error" by the 4338B, has occurred.

**-311 Memory error**

An error was detected in the 4338B's memory.

**-313 Calibration memory lost**

The nonvolatile calibration data has been lost. When this error occurs during power-on test, the 4338B stops operation and asserts the /ALARM signal on the handler interface. When this error occurs during self-test, the 4338B continues operation and asserts the /ALARM signal. Contact your nearest Agilent Technologies office.

**-350 Queue overflow**

A specific code entered into the queue in lieu of the code that caused the error. This code indicates that there is no room in the queue and an error occurred but was not recorded.

**-400 Query errors**

This is the generic query error that the 4338B cannot detect more specific errors. This code indicates only that a query error as defined in IEEE 488.2, 11.5.1.1.7 and 6.3 has occurred.

**-410 Query INTERRUPTED**

A condition causing an interrupted query error occurred (see IEEE 488.2, 6.3.2.3); for example, a query followed by DAB or GET before a response was completely sent.

**-420 Query UNTERMINATED**

A condition causing an unterminated query error occurred (see IEEE 488.2, 6.3.2.2); for example, the 4338B was addressed to talk and an incomplete program message was received by the controller.

**-430 Query DEADLOCKED**

A condition causing an deadlocked query error occurred (see IEEE 488.2, 6.3.1.7); for example, both input buffer and output buffer are full and the 4338B cannot continue.

**-440 Query UNTERMINATED after indefinite response**

A query was received in the same program message after an query requesting an indefinite response was executed (see IEEE 488.2, 6.5.7.5).

# Index

---

## A

:ABORt, 4-10, 5-9  
Adrs key , 3-8  
annunciator, 3-2  
Arrow key, 3-9  
ASCII, 5-41  
    GPIB command, 5-20  
Auto / Hold key, 3-6  
auto level, 3-4  
    GPIB command, 5-25  
Auto Meas key, 3-3  
auto measurement, 3-3  
    how to select, 4-6  
auto range, 3-6  
    GPIB command, 5-24  
:AVERage:COUNT  
    SENSe, 5-22  
Average key , 3-6  
:AVERage:STATe  
    SENSe, 5-22  
averaging rate, 3-6  
    GPIB command, 5-22  
    how to set, 2-2, 4-7

## B

backup memory, 3-3  
:BEEPer  
    CALCulate{1|2}:LIMit, 5-11, 5-12  
    SYSTEM, 5-28  
beeper, 3-12  
    GPIB command, 5-11, 5-28  
    how to set, 2-4, 4-7  
Bk Sp key, 3-10  
BLUE shift key, 3-9  
<Boolean>, 5-6  
BUF1, 5-15  
BUF2, 5-15  
bus trigger mode, 3-7

## C

:CALCulate{1|2}:FORMat, 4-5, 5-11  
:CALCulate{1|2}:LIMit:BEEPer, 4-7, 5-11, 5-12  
:CALCulate{1|2}:LIMit:CLEar, 4-8, 5-12  
:CALCulate{1|2}:LIMit:FAIL?, 4-8, 5-12

:CALCulate{1|2}:LIMit:LOWer[:DATA], 4-8, 5-12  
:CALCulate{1|2}:LIMit:LOWer:STATe, 4-8, 5-13  
:CALCulate{1|2}:LIMit:STATe, 4-8, 5-13  
:CALCulate{1|2}:LIMit:UPPer[:DATA], 4-8, 5-13  
:CALCulate{1|2}:LIMit:UPPer:STATe, 4-8, 5-13  
:CALCulate{1|2}:MATH:EXPRession, 4-8, 5-13, 5-14  
:CALCulate{1|2}:MATH:STATe, 4-8, 5-14  
CALCulate subsystem, 5-10  
calculation sheet , 9-9  
cleaning , 1-9  
:CLEar  
    CALCulate{1|2}:LIMit, 5-12  
\*CLS, 4-23, 5-31  
Command Error (CME) Bit, 5-36  
comparator  
    GPIB command, 5-12, 5-13  
    how to use, 2-7, 4-8  
    limit , 3-9  
    on/off, 3-10  
Comptr key, 3-10  
:CONDition?  
    STATus:OPERation, 5-26  
Config key , 3-12  
Contack Check  
    GPIB command, 5-24  
contact check, 3-11  
    how to set, 2-3  
contact resistance  
    measuring, 6-2  
:CONTinuous  
    INITiate, 5-21  
:CONTrol  
    DATA:FEED, 5-17  
:CORRection:COLLect[:ACquire]  
    SENSe, 5-22  
:CORRection:COLLect:METHOD  
    SENSe, 5-23  
:CORRection:DATA?  
    SENSe, 5-23  
:CORRection[:STATe]  
    SENSe, 5-23

## D

DATA?, 5-16  
data buffer, 4-22, 5-15  
:DATA[:DATA], 4-8, 5-15  
:DATA[:DATA]?, 4-22, 5-16  
:DATA:FEED, 4-22, 5-16  
:DATA:FEED:CONTRol, 4-22, 5-17  
<data\_handle>, 5-6, 5-16  
:DATA:POINts, 4-22, 5-17  
DATA subsystem, 5-15  
:DELay  
    TRIGger[:SEquence1] , 5-30  
Delay key, 3-7  
delay time, 3-7  
    GPIB command, 5-30  
    how to set, 2-2, 4-7  
deviation measurement, 3-5  
    GPIB command, 5-15  
    how to display, 2-8, 4-8  
Device-Dependent Error Bit, 5-36  
display digits  
    how to select, 2-10  
display mode, 2-10, 3-6  
    GPIB command, 5-18  
DISPlay subsystem, 5-18  
Disp Mode key, 3-6  
dry circuit, 7-2

## E

:ENABle  
    STATus:OPERation, 5-26  
    STATus:QUESTionable, 5-27  
Eng key, 3-10  
Enter key, 3-9  
:ERRor?  
    SYSTem, 5-28  
\*ESE, 4-23, 5-31  
\*ESE?, 5-31  
\*ESR?, 4-23, 5-31  
Execution Error Bit, 5-36  
External Trigger , 3-14  
external trigger mode, 2-6, 3-7

## F

:FEED  
    DATA, 5-16  
:FEED:CONTRol  
    DATA, 5-17  
:FETCh?, 4-10, 5-19  
:FIMPedance:APERture  
    SENSe, 5-23  
:FIMPedance:CONtact:VERify  
    SENSe, 5-24  
:FIMPedance:RANGe[:UPPer]  
    SENSe, 5-24

:FORMat, 5-20  
    CALCulate{1|2}, 5-11  
FORMat subsystem, 5-20  
:FUNCTion  
    SENSe, 5-24  
functional test record , 9-16

## G

GET, 4-10  
GPIB address, 3-8  
    how to set, 2-12  
group execution trigger, 4-10

## H

handler interface  
    installation, B-1  
handler interface functional test , 9-14

## I

idle state, 5-39  
\*IDN?, 5-31  
IEEE 754 floating point format, 5-42  
:IMPedance:RANGe:AUTO  
    SENSe, 5-24  
incoming inspection , 1-9  
INITiate, 5-21  
:INITiate:CONTinuous, 4-10, 5-21  
:INITiate[:IMMediate], 4-10, 5-21  
initiate state, 5-40  
INITiate subsystem, 5-21  
internal resistance  
    measuring, 6-5  
internal trigger mode, 2-6, 3-7

## K

key lock, 2-12, 3-11  
    GPIB command, 5-28  
Key Lock key, 3-11  
:KLOCK  
    SYSTem, 5-28

## L

Lcl key, 3-8  
Level key, 3-4  
:LFRequency  
    SYSTem, 5-28  
LINE frequency, 3-12  
    GPIB command, 5-28  
    how to set, 1-13, 4-5  
LINE Fuse Holder , 3-15  
LINE Voltage Selector, 3-15  
local mode, 2-12  
\*LRN?, 4-9, 5-31

## M

- manual changes, A-1
- manual trigger mode, 2-6, 3-7
- :MATH:EXPRession:CATalog?
  - CALCulate{1|2}, 5-13
- :MATH:EXPRession:NAME
  - CALCulate{1|2}, 5-14
- :MATH:STATe
  - CALCulate{1|2}, 5-14
- MAV (Message Available) Bit, 5-35
- Max key, 3-10
- Meas Prmtr key, 3-5
- Meas Time key, 3-5
- measured value display key , 3-5
- measurement parameter, 3-5
  - GPIB command, 5-11
  - how to select, 4-5
- measurement range, 3-6
  - GPIB command, 5-24
  - how to select, 4-6
- Measurement Settings, 2-11
- measurement time mode, 3-5
  - GPIB command, 5-23
  - how to select, 2-2
  - how to set, 4-6
- Min key, 3-10

## N

- <numeric\_value>, 5-5

## O

- \*OPC, 4-8, 5-31
- \*OPC?, 4-8, 5-32
- :OPERation?
  - STATus, 5-26
- Operation Complete Bit, 5-36
- :OPERation:CONDition?
  - STATus, 5-26
- :OPERation:ENABLE
  - STATus, 5-26
- :OPERation[:EVENT]?
  - STATus, 5-26
- operation status register, 5-38
- \*OPT?, 5-32
- OVLd, 3-6
- OVVOL, 3-4

## P

- performance test record , 9-10
- :POINts
  - DATA, 5-17
- power cable , 1-10
- Power Cord Receptacle, 3-15
- Power Requirements, 1-12
- :PRESet

- STATus, 5-27
- SYSTem, 5-29
- Pri key, 3-9

## Q

- Query Error Bit, 5-36
- :QUESTionable?
  - STATus, 5-27
- :QUESTionable:CONDition?
  - STATus, 5-27
- :QUESTionable:ENABLE
  - STATus, 5-27
- questionable status register, 5-38

## R

- Range Setup key, 3-6
- \*RCL, 4-9, 5-32
- Rcl key, 3-9
- real data format, 5-20, 5-42
- recall, 3-9
  - GPIB command, 5-32
  - instrument settings, 2-4
- REF1, 5-15
- REF2, 5-15
- reset, 3-12
  - GPIB command, 5-29
  - how to, 1-20, 4-5
- resistance measurement accuracy test , 9-6
- RQS (Request Service) Bit, 5-35
- \*RST, 4-5, 5-32

## S

- \*SAV, 4-9, 5-32
- save, 3-8
  - GPIB command, 5-32
  - instrument settings, 2-4
- Save key, 3-8
- Sec key, 3-9
- self-test, 3-12
  - GPIB command, 5-33
  - how to perform, 2-13
- :SENSe:AVErAge:COUnT, 4-7, 5-22
- :SENSe:AVErAge[:STATe], 4-7, 5-22
- :SENSe:CORection:COLLect[:ACQuire], 4-5, 5-22
- :SENSe:CORection[:STATe], 4-5, 5-23
- :SENSe:FIMPedance:APERTure, 4-6, 5-23
- :SENSe:FIMPedance:CONtact:VERify, 5-24
- :SENSe:FIMPedance:RANGe:AUTO, 4-6, 5-24
- :SENSe:FIMPedance:RANGe[:UPPER], 4-6, 5-24
- SENSe subsystem, 5-22
- <sensor\_function>, 5-6, 5-24
- serial number, A-3
- Service Request Enable Register, 5-34



Service Request (SRQ), 5-34  
 SHORT correction, 3-11  
     concept, 7-1  
     GPIB command, 5-22, 5-23  
     how to perform, 1-20, 4-5  
 SHORT correction data  
     GPIB command, 5-23  
 Short key, 3-11  
     :SOURce:CURRent, 4-6, 5-25  
     :SOURce:CURRent:AUTO, 4-6, 5-25  
 source delay time, 3-7  
     GPIB command, 5-30  
     how to set, 2-2, 4-7  
 SOURce subsystem, 5-25  
 specifications, 8-2  
 SPOLL, 4-23  
 \*SRE, 4-23, 5-32  
 \*SRE?, 5-32  
 standard event status register, 5-36  
 status, 4-23, 5-34  
 status byte register, 5-35  
     :STATus:OPERation:CONDition?, 4-23,  
         5-26  
     :STATus:OPERation:ENABle, 4-23, 5-26  
     :STATus:OPERation[:EVENT]?, 4-23, 5-26  
     :STATus:PRESet, 4-23, 5-27  
     :STATus:QUESTionable:CONDition?, 4-23,  
         5-27  
     :STATus:QUESTionable:ENABle, 4-23, 5-27  
     :STATus:QUESTionable[:EVENT]?, 4-23,  
         5-27  
 STATus subsystem, 5-26  
 \*STB?, 4-23, 5-33  
 supplemental performance characteristics,  
     8-7  
     :SYSTem:BEEPPer[:IMMEDIATE], 4-7, 5-28  
     :SYSTem:BEEPPer:STATe, 4-7, 5-28  
     :SYSTem:LFRequency, 4-5, 5-28  
     :SYSTem:PRESet, 4-5, 5-29  
 SYSTem subsystem , 5-28

## T

talk only mode, 2-12, 3-8  
 test equipment , 9-1  
 test leads  
     extension, 7-3  
 Test Signal Frequency Accuracy Test , 9-4  
 test signal level, 3-4  
     GPIB command, 5-25  
     how to select, 1-22, 4-6  
 test signal level functional test , 9-12  
 \*TRG, 4-10, 5-33  
 trigger, 3-6  
     GPIB command, 5-33  
     how to, 2-6  
     how to trigger, 4-10  
 TRIGger, 5-30  
 TRIGGER, 4-10  
 trigger delay time, 3-7  
     GPIB command, 5-30  
     how to set, 2-2, 4-7  
 TRIGger:IMMEDIATE, 5-30  
 trigger mode, 3-7  
     GPIB command, 5-30  
     :TRIGger[:SEQUENCE1]:DELay, 4-7, 5-30  
     :TRIGger[:SEQUENCE1][:IMMEDIATE], 4-10,  
         5-30  
     :TRIGger[:SEQUENCE1]:SOURce, 4-10, 5-30  
     :TRIGger:SEQUENCE2:DELay, 4-7, 5-30  
 TRIGger subsystem , 5-30  
 trigger system, 5-39  
 Trig key, 3-6  
 Trig Mode key, 3-7  
 \*TST?, 4-23, 5-33

## U

Δ Mode key , 3-5  
 UNKNOWN terminals, 3-3

## W

\*WAI, 4-8, 5-33

## REGIONAL SALES AND SUPPORT OFFICES

*For more information about Agilent Technologies test and measurement products, applications, services, and for a current sales office listing, visit our web site: <http://www.agilent.com/find/tmdir>. You can also contact one of the following centers and ask for a test and measurement sales representative.* 11/29/99

### **United States:**

Agilent Technologies  
Test and Measurement Call Center  
P.O.Box 4026  
Englewood, CO 80155-4026  
(tel) 1 800 452 4844

(fax) (61 3) 9272 0749  
(tel) 0 800 738 378 (New Zealand)  
(fax) (64 4) 802 6881

### **Canada:**

Agilent Technologies Canada Inc.  
5150 Spectrum Way  
Mississauga, Ontario  
L4W 5G1  
(tel) 1 877 894 4414

### **Asia Pacific:**

Agilent Technologies  
24/F, Cityplaza One, 1111 King's Road,  
Taikoo Shing, Hong Kong  
(tel) (852)-3197-7777  
(fax) (852)-2506-9284

### **Europe:**

Agilent Technologies  
Test & Measurement  
European Marketing Organization  
P.O.Box 999  
1180 AZ Amstelveen  
The Netherlands  
(tel) (31 20) 547 9999

### **Japan:**

Agilent Technologies Japan Ltd.  
Call Center  
9-1, Takakura-Cho, Hachioji-Shi,  
Tokyo 192-8510, Japan  
(tel) (81) 426 56 7832  
(fax) (81) 426 56 7840

### **Latin America:**

Agilent Technologies  
Latin American Region Headquarters  
5200 Blue Lagoon Drive, Suite #950  
Miami, Florida 33126  
U.S.A.  
(tel) (305) 267 4245  
(fax) (305) 267 4286

### **Australia/New Zealand:**

Agilent Technologies Australia Pty Ltd  
347 Burwood Highway  
Forest Hill, Victoria 3131  
(tel) 1-800 629 485 (Australia)