

# **Agilent N9320B Spectrum Analyzer**

## **User's Guide**



**Agilent Technologies**

# Notices

© Agilent Technologies, Inc. 2008-2009

No part of this manual may be reproduced in any form or by any means (including electronic storage and retrieval or translation into a foreign language) without prior agreement and written consent from Agilent Technologies, Inc. as governed by United States and international copyright laws.

## Manual Part Number

N9320-90007

## Edition

Second Edition, Oct, 2009

Printed in China

Agilent Technologies, Inc.  
No. 116 Tuo Xin West Street  
Hi-Tech Industrial Zone (South)  
Chengdu 610041, China

## Software Revision

This guide is valid for B.01.00 revisions of the Agilent N9320B Spectrum Analyzer software.

## Warranty

The material contained in this document is provided “as is,” and is subject to being changed, without notice, in future editions. Further, to the maximum extent permitted by applicable law, Agilent disclaims all warranties, either express or implied, with regard to this manual and any information contained herein, including but not limited to the implied warranties of merchantability and fitness for a particular purpose. Agilent shall not be liable for errors or for incidental or consequential damages in connection with the furnishing, use, or performance of this document or of any information contained herein. Should Agilent and the user have a separate written agreement with warranty terms covering the material in this document that conflict with these terms, the warranty terms in the separate agreement shall control.

## Technology Licenses

The hardware and/or software described in this document are furnished under a license and may be used or copied only in accordance with the terms of such license.

## Restricted Rights Legend

U.S. Government Restricted Rights. Software and technical data rights granted to the federal government include only those rights customarily provided to end user customers. Agilent provides this customary commercial license in Software and technical data pursuant to FAR 12.211 (Technical Data) and 12.212 (Computer Software) and, for the Department of Defense, DFARS 252.227-7015 (Technical Data - Commercial Items) and DFARS 227.7202-3 (Rights in Commercial Computer Software or Computer Software Documentation).

## Safety Notices

### CAUTION

A **CAUTION** notice denotes a hazard. It calls attention to an operating procedure, practice, or the like that, if not correctly performed or adhered to, could result in damage to the product or loss of important data. Do not proceed beyond a **CAUTION** notice until the indicated conditions are fully understood and met.

---

### WARNING

A **WARNING** notice denotes a hazard. It calls attention to an operating procedure, practice, or the like that, if not correctly performed or adhered to, could result in personal injury or death. Do not proceed beyond a **WARNING** notice until the indicated conditions are fully understood and met.

---

## In This User's Guide...

This guide contains operation information for the N9320B Spectrum Analyzer. The following are descriptions of the chapters within this book.

### **1 Overview**

A description of the front and rear panels.

### **2 Getting Started**

Unpacking and setting up the analyzer.

### **3 Functions and Measurements**

How to use the basic applications of the analyzer.

### **4 Key Reference**

Front-panel hardkey descriptions and the related softkeys menu functions.

### **5 Instrument Messages**

Descriptions of the instrument messages of the analyzer.

### **6 Troubleshooting**

Information and tips on what to do when instrument difficulties are encountered.

### **7 Menu Maps**

Menu maps, the structure of the menus and what the user will see when making instrument parameter selections.

For more information about N9320B Spectrum Analyzer, see [www.agilent.com/find/n9320b](http://www.agilent.com/find/n9320b).



# Contents

<b>1</b>	<b>Overview</b>	<b>1</b>
	Agilent N9320B at a Glance	2
	Front Panel Overview	4
	Display Annotations	7
	Rear Panel Overview	9
	Front and rear panel symbols	10
<b>2</b>	<b>Getting Started</b>	<b>11</b>
	Check the Shipment and Order List	12
	Options	13
	Safety Notice	14
	Power Requirements	15
	Power On and Check	17
	Environmental Requirements	19
	Electrostatic Discharge Protection	22
	Some helpful Tips	23
	Perform a Time Base Calibration	23
	Using an External Reference	23
	Enable an Options	24
	Firmware Upgrade	24
	IO Configuration	25
<b>3</b>	<b>Functions and Measurements</b>	<b>27</b>
	Making a Basic Measurement	28

## Contents

Using the Front Panel	28
Presetting the Spectrum Analyzer	29
Viewing a Signal	30
Measuring Multiple Signals	32
Comparing Signals on the Same Screen Using Marker Delta	32
Comparing Signals not on the Same Screen Using Marker Delta	34
Resolving Signals of Equal Amplitude	36
Resolving Small Signals Hidden by Large Signals	39
Measuring a Low-Level Signal	41
Reducing Input Attenuation	41
Decreasing the Resolution Bandwidth	43
Trace Averaging	44
Improving Frequency Resolution and Accuracy	46
Tracking Drifting Signals	48
Measuring a Source's Frequency Drift	48
Making Distortion Measurements	50
Identifying Analyzer Generated Distortion	50
Third-Order Intermodulation Distortion	53
Measuring Phase Noise	56
Stimulus Response Transmission	57
Measuring Stop Band Attenuation of a Lowpass Filter	60
Making a Reflection Calibration Measurement	63
Measuring Return Loss Using the Reflection Calibration Routine	66
Making an Average Power Measurement	67
Making a Basic Average Power Measurement	68
Demodulate the AM/FM signal	71
Demodulating an AM Signal	71
Demodulating an FM Signal	72

Analysis the Modulated Signals	74
AM/FM Modulation Analysis	74
ASK/FSK Modulation Analysis	77
Viewing Catalogs and Saving Files	80

**4Key Reference** 85

Amplitude	86
Auto Tune	89
Back <-	90
BW/Avg	91
Det/Display	95
Enter	101
File/Print	102
Frequency	107
Marker	109
Marker->	115
Meas	116
MODE	133
Peak Search	144
Preset/System	148
SPAN	154
Sweep/Trig	156
View/Trace	158

**5Instrument Messages** 159

Overview	160
Command Errors	161

## Contents

Execution Conflict	163
Device-Specific Errors	165
<b>6Troubleshooting</b>	169
Check the basics	170
Warranty and Service Options	171
Contact Agilent Technologies	172
<b>7Menu Maps</b>	173
<b>Index</b>	195





# 1 Overview

Agilent N9320B at a Glance	2
Front Panel Overview	4
Rear Panel Overview	9
Front and rear panel symbols	10

This chapter provides a description of the Agilent N9320B spectrum analyzer and an introduction to the buttons, features, and functions of the front and rear instrument panels.

## Agilent N9320B at a Glance

The Agilent N9320B spectrum analyzer is a portable, swept spectrum analyzer with a frequency range of 9 kHz to 3.0 GHz. It can be a fundamental component of an automated system. It can also be widely used in an electronic manufacturing environment and in functional/final/QA test systems.

### Features

The Agilent N9320B spectrum analyzer primary features and functions are described below:

- **High sensitive measurement**

The spectrum analyzer includes an optional pre-amplifier for signals in the frequency range up to 3 GHz, enabling more sensitive measurements. This feature is a great help in analysis of weaker signals.

- **High Accuracy Power Measurement**

The N9340B supports Agilent U2000 series power sensors for high accuracy power measurement as a power meter.

- **Power Measurement Suite**

The built-in one-button power measurement suite offers channel power, ACP, OBW, and TOI measurements.

- **Spectrum Emission Mask**

provides a Pass/Fail testing capability with a mask for out-of-channel emissions measurement.

- **Modulation analysis function**

provides optional AM/FM and ASK/FSK modulation analysis function. (AM/FM: Option-AMA ASK/FSK: Option-DMA)

- **Tracking generator**

provides an RF source for scalar network analysis (Option-TG3).

For the latest product technical information, please refer to the link below:

<http://www.agilent.com/find/n9320b>

For the latest option information, please refer to the link below:

[http://www.agilent.com/find/sa\\_upgrades](http://www.agilent.com/find/sa_upgrades)

## Front Panel Overview

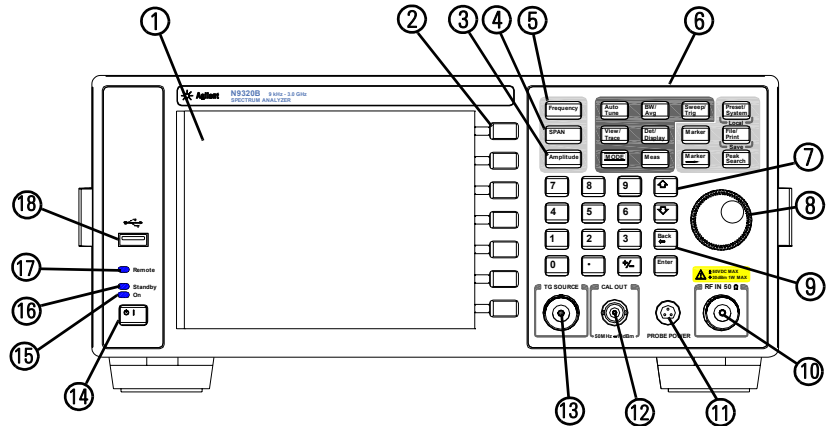

- 1 **Screen** 6.5 inch TFT color screen shows information of the current function, including the signal traces, status indicators, and instrument messages. Labels for softkeys are located on the right-hand side of the screen.
- 2 **Softkeys** are the unlabeled keys next to the screen. They activate functions displayed to the left of each key.
- 3 **Amplitude** activates the reference level function and accesses the amplitude softkeys, with which you set functions that affect data on the vertical axis.
- 4 **SPAN** sets the frequency range symmetrically about the center frequency. The frequency-span readout describes the total displayed frequency range.
- 5 **Frequency** activates the center-frequency function, and accesses the menu of frequency functions.
- 6 **Function Keys** relate directly to the following main functions:
  - **Preset/System (Local)** accesses the softkeys to reset the analyzer to a known state, if the analyzer is in the remote mode, pressing this key returns the analyzer to the local mode and enables front-panel control.

- **Auto Tune** searches the signal automatically and locates the signal to the center of the graticule. see “Auto Tune” on page 89.
  - **BW/Avg** activates the resolution bandwidth function and accesses the softkeys that control the bandwidth functions and averaging.
  - **Sweep/Trig** accesses the softkeys that allow you to set the sweep time, select the sweep mode and trigger mode of the analyzer.
  - **View/Trace** accesses the softkeys that allow you to store and manipulate trace information.
  - **Det/Display** accesses the softkeys that allow you to configure detector functions and control what is displayed on the analyzer, including the display line, graticule and annotation, as well as the testing of trace data against entered limits.
  - **MODE** selects the measurement mode of your analyzer.
  - **Meas** accesses the softkeys that let you make transmitter power measurements such as adjacent channel power, occupied bandwidth, and harmonic distortion, etc.
  - **Marker** accesses the marker control keys that select the type and number of markers and turns them on and off.
  - **Marker→** accesses the marker function softkeys that help you with the measurement.
  - **Peak Search** places a marker on the highest peak.
  - **File/Print** accesses the softkeys that allow you to configure the file and printing system of the analyzer.
- 7 Arrow Keys** The up and down arrow keys shift the selected item when you press [MODE] hardkey; you can also change the mode by rotating the knob.
- 8 Knob** The front panel knob increases or decreases a value, a numeric digit, or scrolls up and down to select an item in a list.

- 9 **Data Control Keys** includes the numeric keypad, ENTER key and backspace key, change the numeric value of an active function such as center frequency, start frequency, resolution bandwidth, and marker position.
- 10 **RF IN connector** is the signal input for the analyzer. The maximum damage level is average continuous power +40 dBm, DC voltage 50 VDC or max pulse voltage 125 V. The impedance is 50  $\Omega$  (N-type female).
- 11 **PROBE POWER connector** provides power for high-impedance AC probes or other accessories (+15 V, -12 V, 150 mA maximum).
- 12 **CAL OUT connector** provides an amplitude reference signal output of 50 MHz at -10 dBm (BNC female).
- 13 **TG SOURCE connector** N-type female, is the source output for the built-in tracking generator. The impedance is 50  $\Omega$  (for Option TG3)

**CAUTION**

If the tracking generator output power is higher than the maximum power that the device under test can tolerate, it may damage the device under test. Do not exceed the maximum power of DUT.

- 
- 14 **Standby Switch** switches on all functions of the analyzer. To switch the analyzer off, press the switch for at least 2 seconds. This deactivates all the functions but retains power to internal circuits so long as the analyzer is connected to line power.
  - 15 **On LED** (green) lights when the analyzer is switched on.
  - 16 **Standby LED** (orange) lights when the analyzer is connected to the line power.
  - 17 **Remote LED** lights when the analyzer is remotely controlled by a PC via the USB host interface on the rear panel.
  - 18 **USB Device Connector** provides a connection between external USB devices and the analyzer, such as a USB memory device.

## Display Annotations

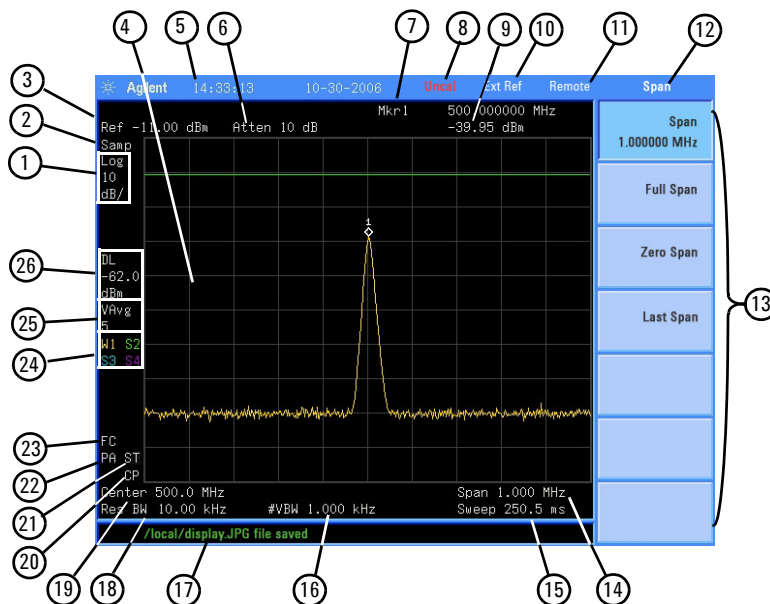

Item	Description	Notes (Associated function key)
1	Amplitude scale	[Amplitude] > Scale Type
2	Detector mode	[Det/Display] > Detector
3	Reference level	[Amplitude] > Ref Level
4	Active function block	The function in use
5	Time and date display	[Preset/System] > Time/Date
6	RF attenuation	[Amplitude] > Attenuation Auto
7	Marker frequency	[Marker] or [Marker] > Function > Frequency Counter
8	Uncal indicator	The readout of amplitude is uncalibrated.
9	Marker amplitude	[Marker]
10	External reference	An external frequency reference is in use.
11	Remote mode	The analyzer is in remote mode
12	Key menu title	Dependent on key selection.

## 1 Overview

13	Softkey menu	Refer to “ <a href="#">Key Reference</a> ” for details. Dependent on current function key selection.
14	Frequency span	[SPAN]
15	Sweep time	[Sweep/Trig] > Sweep Time
16	Video bandwidth	[Bw/Avg] > Video BW
17	Display status line	Display status and instrument messages.
18	Resolution bandwidth	[Bw/Avg] > Res BW
19	Trigger/Sweep <b>F</b> - free run trigger <b>L</b> - line trigger <b>V</b> - video trigger <b>E</b> - external trigger <b>C</b> - continuous sweep <b>S</b> - single sweep	[Sweep/Trig]
20	Continuous peak	[Peak Search] > Continuous pk
21	Signal track	[SPAN] > Span
22	Internal preamp	[Amplitude] > Int Preamp
23	Key menu title	Dependent on key selection
24	Trace mode <b>W</b> - clear write <b>M</b> - maximum hold <b>m</b> - minimum hold <b>V</b> - view <b>S</b> - store blank	[Trace]
25	Average <b>VAvg</b> - video average <b>PAvg</b> - power average	[Bw/Avg] > Average On Off
26	Display line	[Det/Display] > display Line On Off



## Rear Panel Overview

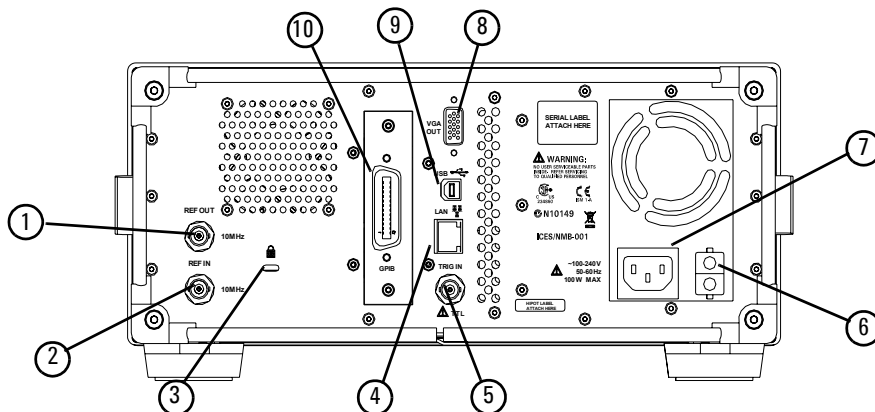

- 1 **REF OUT connector** provides a frequency of 10 MHz, amplitude of  $-10$  dBm reference output. (BNC female)
- 2 **REF IN connector** accepts an external timebase with a frequency of 10 MHz, amplitude of  $-5$  to  $+10$  dBm. (BNC female)
- 3 **Kensington Lock** lock the instrument and keep its safety.
- 4 **LAN port** A TCP/IP Interface that is used for remote analyzer operation.
- 5 **EXT TRG IN (TTL) connector** accepts an external voltage input, the positive edge of which triggers the analyzer sweep function. (BNC female)
- 6 **Power switch** isolates the analyzer from the AC line power. After switch on, the analyzer enters into standby mode and the orange standby LED on the front panel lights.
- 7 **AC Power Receptacle** accepts a three-pin line power plug.
- 8 **VGA connector** provides the video output signal to an external monitor or projector. (D-sub 15-pin female)
- 9 **USB Host connector** provides a connection between the analyzer and an PC for remote control.
- 10 **GPIB connector** (Option G01) is an optional interface. GPIB supports remote analyzer operation.

## Front and rear panel symbols



**The instruction manual symbol:** indicates that the user must refer to specific instructions in the manual.



**The CE mark:** a registered trademark of the European Community.

**ISM1-A**

Shows that this is an Industrial Scientific and Medical Group 1 Class A product. (CISPR 11, Clause 4)



**The CSA mark:** a registered trademark of the Canadian Standards Association International.

**ICES/NMB-001**

The ISM device complies with Canadian Interference-Causing Equipment Standard-001.  
Cet appareil ISM est conforme à la norme NMB-001 du Canada.



**The C-Tick mark:** a trademark registered to the Australian Communication Media Authority. It indicates compliance with all Australian EMC regulatory information.



marks the “on/standby” position of the switch.



indicates that the instrument requires AC power input.



indicates this product complies with the **WEEE Directive**(2002/96/EC) marking requirements and you must not discard this equipment in domestic household waste. Do not dispose in domestic household waste. To return unwanted products, contact your local Agilent office, or refer to <http://www.agilent.com/environment/product/>



## 2 Getting Started

Check the Shipment and Order List	12
Safety Notice	14
Power Requirements	15
Power On and Check	17
Environmental Requirements	19
Electrostatic Discharge Protection	22
Some helpful Tips	23

This chapter helps you in preparing the spectrum analyzer for use and provides the information to start using the spectrum analyzer correctly.



## Check the Shipment and Order List

After receiving the shipment, first check the shipment and your order list.

Inspect the shipping container and the cushioning material for signs of stress. Retain the shipping materials for future use, as you may wish to ship the analyzer to another location or to Agilent Technologies for service. Verify that the contents of the shipping container are complete.

Each spectrum analyzer includes the following accessories as standard:

Item	Description
USB cable (A-B)	Connection for remote control
N-BNC adapter and BNC cable	Connection for alignment
Printed Quick Start Guide	Documentation
Three-pin power cord	Specific to shipping location
Help kit CD-ROM	Remote control Software Agilent IO libraries suite PDF files for quick start guide & user's guide

### Shipping Problems?

If the shipping materials are damaged or the contents of the container are incomplete:

- Contact the nearest Agilent Technologies office to arrange for repair or replacement. You will not need to wait for a claim settlement.
- Keep the shipping materials for the carrier's inspection.
- If you must return an analyzer to Agilent Technologies, use the original (or comparable) shipping materials.

For any questions about your shipment, please contact Agilent Technologies for consulting and service.

## Options

Verify if that the shipment includes your ordered options by checking the option label on the shipping container:

Option	Description	Part number
PA3	3 GHz Preamplifier	N9320B-PA3
G01	GPIB interface	N9320B-G01
AMA	AM/FM demodulation	N9320B-AMA
DMA	ASK/FSK demodulation	N9320B-DMA
TG3	3 GHz tracking generator	N9320B-TG3
EMF	EMC filter	N9320B-EMF
TR1	RF training kit	N9320B-TR1
1HB	Handle and bumpers	N9320B-1HB
1CM	Rackmount kit	N9320B-1CM
1TC	Hard transit case	N9320B-1TC
UK6	Commercial calibration certificate with testing data	N9320B-UK6

Unless specified otherwise, all options are available when you order a spectrum analyzer; some options are also available as kits that you can order and install/activate after you receive the analyzer. Order kits through your local Agilent Sales and Service Office.

At the time of analyzer purchase, options can be ordered using your product number and the number of the option you are ordering. For example, if you are ordering option TG3, you would order N9320B-TG3.

If you are ordering an option after the purchase of your analyzer, you will need to add a K to the product number and then specify which option you are ordering. For example, N9320BK-TG3.

For the latest information on Agilent N9320B spectrum analyzer options and upgrade kits, visit the following Internet URL:

<http://www.agilent.com/find/n9320b>

## Safety Notice

Read the following warnings and cautions carefully before powering on the spectrum analyzer to ensure personal and instrument safety.

**WARNING**

**Always use a well-grounded, three-pin AC power cord to connect to power source. Personal injury may occur if there is any interruption of the AC power cord. Intentional interruption is prohibited. If this product is to be energized via an external auto transformer for voltage reduction, make sure that its common terminal is connected to a neutral (earthed pole) of the power supply.**

---

**WARNING**

**Personal injury may result if the spectrum analyzer covers are removed. There are no operator-serviceable parts inside. To avoid electrical shock, refer servicing to qualified personnel.**

---

**WARNING**

**Electrical shock may result if the spectrum analyzer is connected to the power supply while cleaning. Do not attempt to clean internally.**

---

**CAUTION**

Prevent damage to the instrument and ensure protection of the input mixer by limiting average continuous power input to +33 dBm, DC voltage to 50 VDC with  $\geq 10$  dB input attenuation. Instrument damage may result if these precautions are not followed.

---

**CAUTION**

To install the spectrum analyzer in other racks, note that they may promote shock hazards, overheating, dusting contamination, and inferior system performance. Consult your Agilent customer engineer about installation, warranty, and support details.

---

## Power Requirements

The spectrum analyzer has an auto-ranging line voltage input. The AC power supply must meet the following requirements:

---

<b>Voltage:</b>	100 to 240 VAC (90 to 264 VAC)
<b>Frequency:</b>	50 to 60 Hz
<b>Power:</b>	Maximum 100 W

---





### AC Power Cord

The analyzer is equipped with a three-wire power cord, in accordance with international safety standards. This cable grounds the analyzer cabinet when connected to an appropriate power line outlet. The cable appropriate to the original shipping location is included with the analyzer.

Various AC power cables are available that are unique to specific geographic areas. You can order additional AC power cables for use in different areas. The table **AC Power Cords** lists the available AC power cables, the plug configurations, and identifies the geographic area in which each cable is appropriate.

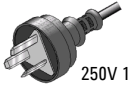
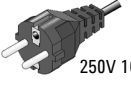
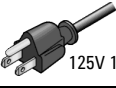
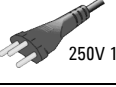
The detachable power cord is the product disconnecting device. It disconnects the mains circuits from the mains supply before other parts of the product. The front panel switch is only a standby switch and do not disconnect instrument from LINE power.

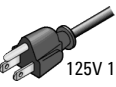
### AC Power Cords

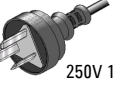
Plug Type	Cable Part Number	Plug <sup>a</sup> Description	For use in Country & Region
 250V 10A	8121-1703	BS 1363/A	Option 900 United Kingdom, Hong Kong, Singapore, Malaysia
 250V 10A	8120-0696	AS 3112:2000	Option 901 Australia, New Zealand
 250V 16A	8120-1692	IEC 83 C4	Option 902 Continental Europe, Korea, Indonesia, Italy, Russia
 125V 10A	8120-1521	CNS 10917-2 /NEMA 5-15P	Option 903 United States, Canada, Taiwan, Mexico
 250V 10A	8120-2296	SEV 1011	Option 906 Switzerland
 230V 15A	8120-4600	SABS 164-1	Option 917 South Africa, India
 125V 15A	8120-4754	JIS C8303	Option 918 Japan
 250V 16A	8120-5181	SI 32	Option 919 Israel
 250V 10A	8120-8377	GB 1002	Option 922 China

a. Plug description describes the plug only. The part number is for the complete cable assembly.





## Power On and Check

- 1 Connect the AC power cord into the instrument. Insert the plug into a power socket provided with a protective ground. Set the tilt adjusters for your preference.

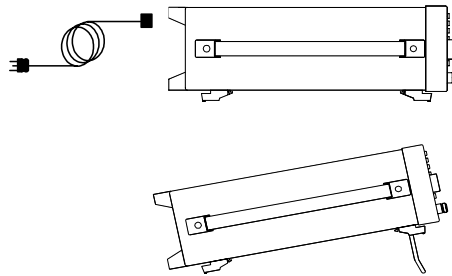
**Figure 2-1 Plug in and angle adjustment**



- 2 Press the AC line switch  on the rear panel. The standby LED on the front panel will light and the spectrum analyzer is in standby mode (AC power applied).
- 3 Press the standby switch  on the front panel. The On LED will light, and the spectrum analyzer boots up.

Self-initialization takes about 25 seconds; the spectrum analyzer then defaults to the menu mode. After power on, let the spectrum analyzer warm up for 45 minutes for stabilization.

### NOTE

The front panel switch is a standby switch only; it is not a power switch. To completely disconnect the spectrum analyzer from the AC line power, shut off the power switch on the rear panel.

## Running Internal Alignments

To meet the instrument performance specifications, the analyzer must periodically be manually aligned.

- 1 Connect a BNC cable with the N-BNC adapter between the **CAL OUT** and **RF IN** front panel connectors.
- 2 After 15-minute warm up, press  > **Alignment > Align > All**

The self alignment takes about 5 minutes.



When an alignment is being run, there will be an audible clicking sound as the attenuator settings are changed.

This sound is not an indication of a problem. Please refer to “[Alignment](#)” on page 150 for further information.

## Check for Instrument Messages

The spectrum analyzer has two categories of instrument messages: error and warning messages. A error message is triggered by operation errors, for example, parameter setting conflicts or data input that is out of the range of a parameter. An warning message may be triggered by hardware defects which could result in damage to instrument.

Here are some tips to check the instrument messages.

- 1 Check the display to see if any messages display in the status bar. Press  > **More > Show Errors** to review each message. Refer to [Chapter 5](#), “Instrument Messages” for detailed system message descriptions.
- 2 When you have reviewed and resolved all of the error messages, press  > **More > Show Errors > Clear error queue** to delete the messages.
- 3 Cycle the power to the analyzer and re-check to see if the instrument messages are still there.
- 4 If the error messages cannot be resolved, please contact the Agilent Customer Contact Center for assistance or service.

## Environmental Requirements

Agilent Technologies has designed this product for use in Installation Category II, Pollution Degree 2, per IEC 61010-1. Agilent has designed the spectrum analyzer for use under the following conditions:

- Indoor use
- Altitude < 3,000 meters
- Operating temperature range: +5 to +45 °C;  
Storage temperature range: -20 to +70 °C
- Relative humidity range 15% to 95 %

## Ventilation

Ventilation holes are located on the rear panel and one side of the spectrum analyzer cover. Do not allow these holes to be obstructed, as they allow air flow through the spectrum analyzer.

When installing the spectrum analyzer in a cabinet, do not restrict the convection of the analyzer. The ambient temperature outside the cabinet must be less than the maximum operating temperature of the spectrum analyzer by 4 °C for every 100 watts dissipated within the cabinet.

## Cleaning Tips

To prevent electrical shock, disconnect the spectrum analyzer from line power before cleaning. Use a dry cloth or one slightly dampened with water to clean the external case parts. Do not attempt to clean internally.

## Rack Mount

It is recommended to use the Agilent rackmount kit (option 1CM) to install the spectrum analyzer into a rack.

Do not attempt to rack mount the spectrum analyzer by the front panel handles only. This rackmount kit will allow mounting of the spectrum analyzer with or without handles.

Refer to the following instructions when installing the rackmount kit on the spectrum analyzer.

- 1 Remove feet, key-locks and tilt stands.
- 2 Remove side trim strips and one middle screw per side.

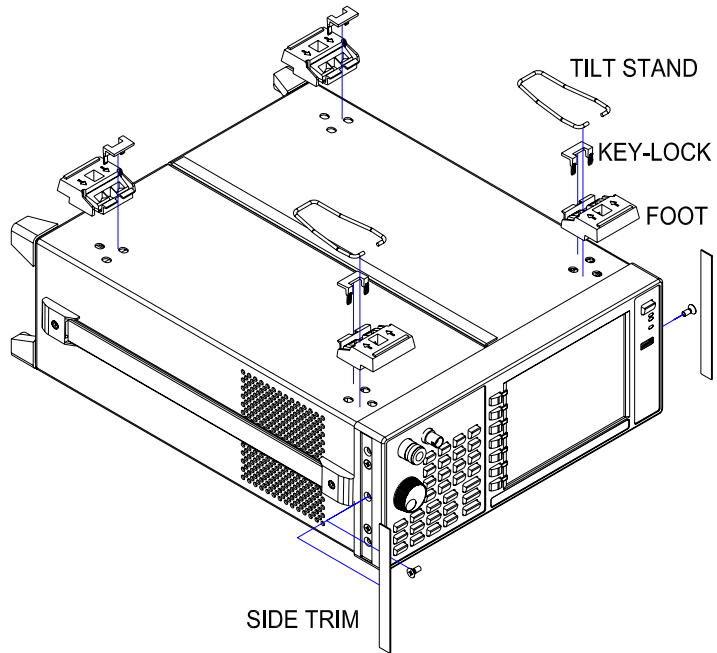

- 3 Attach rackmount flange and front handle assembly with 3 screws per side.

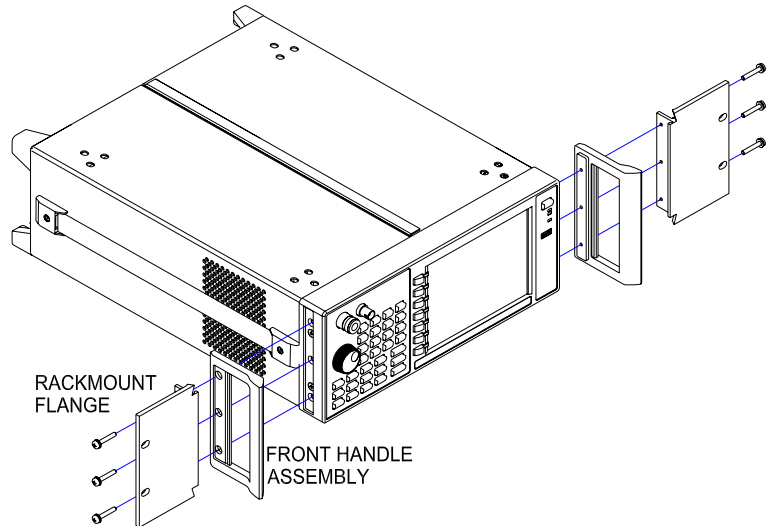

- 4 Attach the spectrum analyzer to the rack using the rackmount flanges with two dress screws per side.

### CAUTION

Installing the spectrum analyzers into other racks may promote shock hazards, overheating, dust contamination, and inferior system performance. Consult your Agilent customer engineer about installation, warranty, and support details.

## Transit

It is recommended to use the hard transit case (option ITC) for instrument transportation.

## Electrostatic Discharge Protection

Electrostatic discharge (ESD) damages or destroys electronic components (the possibility of unseen damage caused by ESD is present whenever transported, stored, or while the instrument is in use).

This product contains components that are easily damaged by electrostatic discharge. To help reduce the possibility of ESD damage that can occur while using test equipment, follow these guidelines:

- 1 Before connecting any coaxial cable to the spectrum analyzer connector for the first time each day, momentarily short the center and outer conductors of the cable together to eliminate any potential electrostatic charges that may exist.
- 2 Personnel should be grounded with an approved type, 1 M $\Omega$  resistor-isolated ESD wrist-strap before touching the center pin of any connector, and before removing any assembly from the spectrum analyzer.
- 3 Be sure that all instruments are properly earth grounded to prevent build-up of static charges.

For more information about ESD and how to prevent ESD damage, contact the Electrostatic Discharge Association (<http://www.esda.org>). The ESD standards developed by this agency are sanctioned by the American National Standards Institute (ANSI).

## Some helpful Tips

The following contains information to help in using and maintaining the instrument for optimum operation, including alignment, external reference, firmware update and option activation.

### Perform a Time Base Calibration

The N9340B provides a manual calibration function to calibrate the time base. The analyzer should warm up for approximately 30 minutes before calibration.

When the calibration function is triggered, the current measurement is interrupted and a gauge displays on the LCD. The gauge simply indicates calibration action rather than calibration course, as the calibration time is unpredictable. When the calibration is finished, the LCD displays a calibration, and the interrupted measurement restarts.

Please refer to the operation procedures as below:

- 1 Connect a BNC cable with a correct type N-BNC adapter between the **CAL OUT** and **RF IN** front panel connectors.
- 2 Press  > **Alignment** > **Timebase** to initiate a calibration.

### Using an External Reference

To use an external 10 MHz source as the reference frequency, connect the external reference source to the **REF IN** connector on the rear panel. An **EXT REF** indicator will display in the upper bar of the display. The signal level must be in the range of  $-5$  to  $+10$  dBm.

## Enable an Options

Option license key information is required to enable product options. Contact your nearest Agilent Office for purchasing a license. Refer to the procedures below to activate the options you have purchased.

- 1 Press  > **More** > **More** > **Licensing** > **Option**
- 2 Enter the option number to be enabled. Press **[Enter]** to confirm your input.
- 3 Press **License key**, enter the license key in the onscreen window. Press **[Enter]** to confirm your input and terminate the license key input.
- 4 Press **Activate License**. The option will be enabled immediately.

## Firmware Upgrade

Press  > **{More}** > **{Show software}** to view the firmware revision of your analyzer. If you call Agilent Technologies regarding your analyzer, it is helpful to have this revision and the analyzer serial number available. To update the firmware, refer to:

<http://www.agilent.com/find/n9320b>

Follow this procedure to finish the firmware update:

- 1 Download the firmware package from web. Extract and copy the file *version* and folder “*n9320b*” into the root directory of a USB stick.
- 2 Insert the USB stick into the USB connector. Press  > **{More}** > **{Upgrade}**

The analyzer will perform the update process automatically. The upgrade procedure will take several minutes.

### CAUTION

Any interruption during the update process will result in update failure and system data lost. Do not remove the USB storage device until the update is finished.



## IO Configuration

The N9320B spectrum analyzer provides 3 types of IO connection: USB, LAN and optional GPIB interface. Press  > **{IO Configure}** to select the corresponding interface as your need.

### USB

Select USB to enable the USB connection for remote control.

### LAN

The N9320B supports LAN port connection for remote control. Press  > **{More}** > **{More}** > **{IP Admin}** to set the IP parameters for the network connection.

Press **{IP Select Static}** to manually set the IP address, gateway and subnet mask with the proper LAN information, or just press **{IP Select DHCP}** to set the IP address in LAN dynamically according DCHP.

Press **{Apply}** to enable all the parameters you set.

Press  > **{IO Configure}** > **{LAN}** to enable the LAN connection according to the IP configuration you set.

### GPIB

Press  > **{GPIB Address}** to set the GPIB address for the analyzer.

Press  > **{IO Configure}** > **{GPIB}** to enable the GPIB connection. The GPIB softkey is only valid after the option G01 installed.



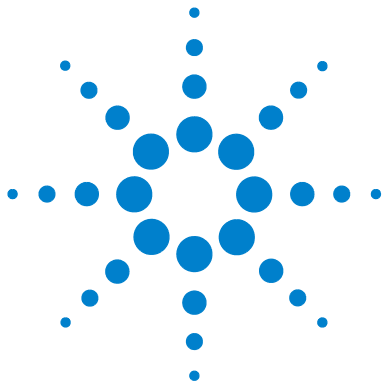

## 3 Functions and Measurements

Making a Basic Measurement	28
Measuring Multiple Signals	32
Measuring a Low-Level Signal	41
Improving Frequency Resolution and Accuracy	46
Tracking Drifting Signals	48
Making Distortion Measurements	50
Measuring Phase Noise	56
Stimulus Response Transmission	57
Measuring Stop Band Attenuation of a Lowpass Filter	60
Making a Reflection Calibration Measurement	63
Measuring Return Loss with the Reflection Calibration Routine	66
Making an Average Power Measurement	67
Demodulate the AM/FM signal	71
Analysis the Modulated Signals	74
Viewing Catalogs and Saving Files	80

This chapter provides information on the analyzer functions and specific measurements capabilities of the spectrum analyzer.

## Making a Basic Measurement

In this guide, the keys labeled with [ ], for example, **[Preset/System]** refer to front-panel hardkeys. Pressing many of the hardkeys accesses softkey menus that are displayed along the right side of the screen. The softkey menu labels are aligned so that they are located next to the softkeys at the right side of the display screen. For example, **Preset** is a softkey menu selection when first pressing **[Preset/System]**.

### Using the Front Panel

This section provides you with the information on using the front panel of the spectrum analyzer.

#### Entering Data

When setting the measurement parameters, there are several ways to enter or modify the value of the active function:

- Knob** Increments or decrements the current value.
- Arrow Keys** Increments or decrements the current value by a step unit.
- Numeric Keys** Enters a specific value. Then press the desired terminator (either a unit softkey, or **[Enter]** hardkey).
- Unit Softkeys** Terminate (enter) a value with a unit softkey from the menu.
- Enter Key** Terminates an entry when no unit of measure is required, or the instrument uses the default unit.
- Back Key** To delete the current input digit prior to entering the value.

#### Using Softkeys

Softkeys are used to modify the analyzer function parameter settings. Some examples of softkey types are:

- Toggle** Turn on or off an instrument state.
- Submenu** Displays a secondary menu of softkeys, **{More}**.
- Choice** Selecting from a list of standard values or filenames.
- Adjust** Highlights the softkey and sets the active function.

## Presetting the Spectrum Analyzer

Preset function provides a known instrument status for making measurements. There are two types of presets, factory and user:

- Factory Preset** When this preset type is selected, it restores the analyzer to its factory-defined state. A set of known instrument parameter settings defined by the factory. Refer to “[Factory Preset State](#)” on page 149 for details.
- User Preset** Restores the analyzer to a user-defined state. A set of user defined instrument parameter settings saved for assisting the user in quickly returning to known a instrument measurement setup.

Press  > **Pwr on/Preset** > **Preset Type** to select the preset type.

When **Preset Type** is set to **Factory**, pressing  > **Pres** triggers a factory preset condition. The instrument will immediately return to the factory default instrument parameter setting.

When **Preset Type** is set to **User**, pressing  > **Pres** displays both **User Preset** and **Factory Preset** softkeys. The user may then select the preset desired from the softkey menu selections.

### Setting up a User Preset

To quickly return to instrument settings that are user defined, perform the following steps to save the instrument state as the user-defined preset:

- 1 Set the instrument parameters to the values and settings necessary for the user preset state. This would include the frequency, span, amplitude, BW, and measurement type and any other setup details desired.
- 2 Press  > **Pwr on/Preset** > **Save User Preset**, to save the current instrument settings as the ‘user preset’ state. The user preset will not affect the default factory preset settings. User preset settings can be changed and saved at any time.

## Viewing a Signal

Refer to the procedures below to view a signal.

- 1 Press **Preset/System** > **Pow on/Preset** > **Preset Type** > **Factory** to enable the factory-defined preset state.
- 2 Press **Preset/System** > **Presets** to restore the analyzer to its factory-defined state.
- 3 Connect the 10 MHz **REF OUT** on the rear panel to the front-panel **RF IN**.

### Setting the Reference Level and Center Frequency

- 1 Press **Amplitude** > **10** > **dBm** to set 10 dBm reference level.
- 2 Press **Frequency** > **30** > **MHz** to set 30 MHz to center frequency.

### Setting Frequency Span

Press **SPAN** > **50** > **MHz** to set 50 MHz frequency span.

#### NOTE

Changing the reference level changes the amplitude value of the top graticule line. Changing the center frequency changes the horizontal placement of the signal on the display. Increasing the span will increase the frequency range that appears horizontally across the display.

### Reading Frequency and Amplitude

- 1 Press **Peak Search** to place a marker (labeled 1) on the 10 MHz peak.

Note that the frequency and amplitude of the marker appear both in the active function block, and in the upper-right corner of the screen.

**Figure 3-1 10 MHz Internal Reference Signal**

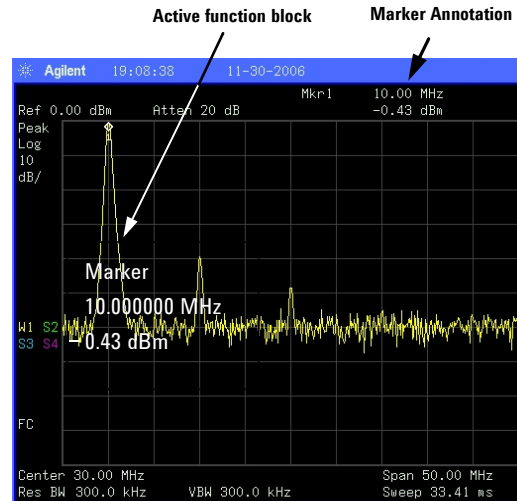

- 2 Use the knob, the arrow keys, or the softkeys in the **Peak Search** menu to move the marker. The marker information will be displayed in the upper-right corner of the screen.

### Changing Reference Level

- 1 Press **Amplitude** and note that reference level (**Ref Level**) is now the active function.
- 2 Press **Marker** > **Mkr-> Ref Lvl.**

**NOTE**

Changing the reference level changes the amplitude value of the top graticule line.







## Measuring Multiple Signals

This section provides the information on how to measure multiple signals.

### Comparing Signals on the Same Screen Using Marker Delta

The delta marker function allows the user to compare two signals when both appear on the screen at the same time.

In the following example, harmonics of the 10 MHz reference signal available are used to measure frequency and amplitude differences between two signals on the same screen. Delta marker is used to demonstrate this comparison.

- 1 Preset the analyzer:  
Press  > **Preset** (With **Preset Type** of **Factory**)
- 2 Connect the rear panel **REF OUT** to the front panel **RF IN**.
- 3 Set the analyzer center frequency, span and reference level to view the 10 MHz signal and its harmonics up to 50 MHz:  
Press  > **30** > **MHz**  
Press  > **50** > **MHz**  
Press  > **10** > **dBm**
- 4 Place a marker at the highest peak on the display (10 MHz):  
Press   
The marker should be on the 10 MHz reference signal. Use the **Next Pk Right** and **Next Pk Left** softkeys to move the marker from peak to peak.
- 5 Anchor the first marker and activate a second marker:  
Press  > **Delta** > **Delta (On)**  
The label on the first marker now reads 1R, indicating that it is marking the reference point.
- 6 Move the second marker to another signal peak using the front-panel knob or by using **Peak Search**.



Press **Peak Search** > **Next Peak** or

Press **Peak Search** > **Next Pk Right** or **Next Pk Left**. Continue pressing the **Next Pk** softkeys until the marker is on the correct signal peak.

The amplitude and frequency differences between the markers are displayed in the active function block.

**Figure 3-2 Delta pair marker with signals on the same screen**

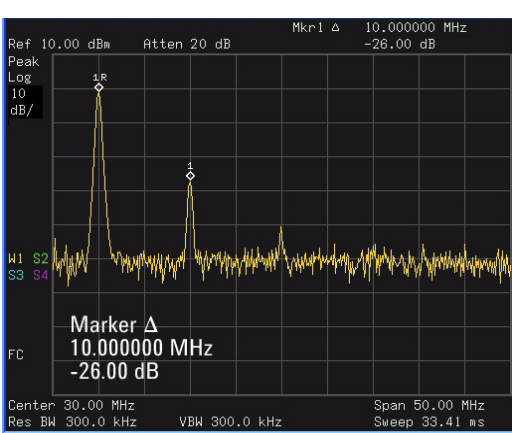









**NOTE**

To increase the resolution of the marker readings, turn on the frequency count function. For more information, refer to [“Improving Frequency Resolution and Accuracy”](#) on page 46.

## Comparing Signals not on the Same Screen Using Marker Delta

The analyzer will compare the frequency and amplitude differences between two signals which are not displayed on the screen at the same time. (This technique is useful for harmonic distortion tests.)

In this example, the analyzer's 10 MHz signal is used to measure frequency and amplitude differences between a signal on screen, and another signal off screen. Delta marker is used to demonstrate this comparison.

- 1 Preset the analyzer:  
Press  > **Preset** (With **Preset Type** set to **Factory**)
- 2 Connect the rear panel **REF OUT** to the front panel **RF IN**.
- 3 Set the center frequency, span and reference level to view only the 50 MHz signal:  
Press  > **Center Freq** > **50** > **MHz**  
Press  > **Span** > **25** > **MHz**  
Press  > **Ref Level** > **10** > **dBm**
- 4 Place a marker on the 50 MHz peak and then set the center frequency step size equal to the marker frequency (10 MHz):  
Press   
Press  > **Mkr** -> **CF Step**
- 5 Activate the marker delta function:  
Press  > **Delta** > **Delta (On)**
- 6 Increase the center frequency by 10 MHz:  
Press  > **Center Freq**, 

The first marker moves to the left edge of the screen, at the amplitude of the first signal peak.

Figure 3-3 shows the reference annotation for the delta marker (1R) at the left side of the display, indicating that the marker set at the 50 MHz reference signal is at a lower frequency than the frequency range currently displayed.

**Figure 3-3 Delta Marker with Reference Signal Off-Screen**

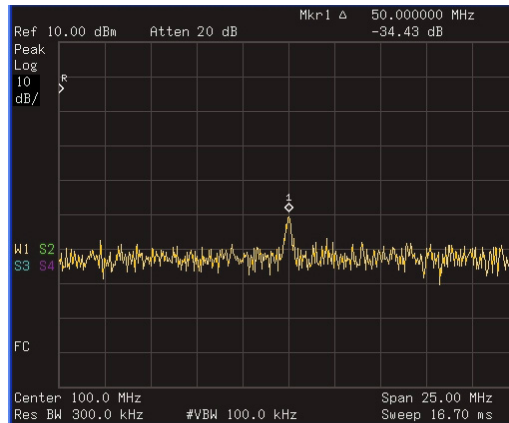

The delta marker appears on the peak of the 100 MHz component. The delta marker annotation displays the amplitude and frequency difference between the 50 and 100 MHz signal peaks.

- 7 Press **Marker** > **Off** to turn the markers off.

## Resolving Signals of Equal Amplitude

In this example a decrease in the resolution bandwidth (RBW) is used in combination with a decrease in video bandwidth (VBW) to resolve two signals of equal amplitude with a frequency separation of 100 kHz.

**Figure 3-4 Setup for obtaining two signals**

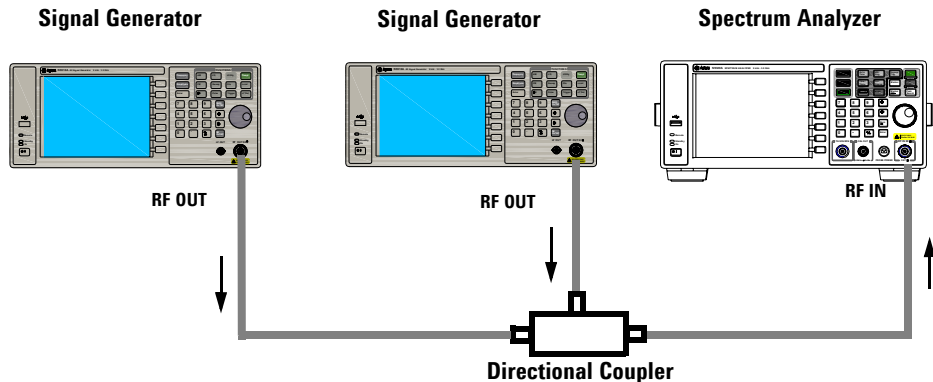

Notice that the final RBW selection to resolve the signals is the same width as the signal separation while the VBW is slightly narrower than the RBW.

- 1 Connect two sources to the analyzer input as shown above.
- 2 Set one source to 300 MHz. Set the frequency of the other source to 300.1 MHz. Set both source amplitudes to -20 dBm.
- 3 Setup the analyzer to view the signals:

Press **Preset/System** > **Preset** (With **Preset Type** of **Factory**)

Press **Frequency** > **300** > **MHz**

Press **BW/Avg** > **300** > **kHz**

Press **SPAN** > **2** > **MHz**

A single signal peak is visible. See [Figure 3-5](#) for example.

If the signal peak is not present on the display, increase the frequency span out to 20 MHz, turn signal tracking on, decrease the span back to 2 MHz and turn signal tracking off:

Press **SPAN** > **Span** > **20** > **MHz**

Press **Peak Search**

Press **Frequency** > **Signal Track (On)**

Press **SPAN** > **2** > **MHz**

Press **Frequency** > **Signal Track (Off)**

**Figure 3-5 Unresolved Signals of Equal Amplitude**

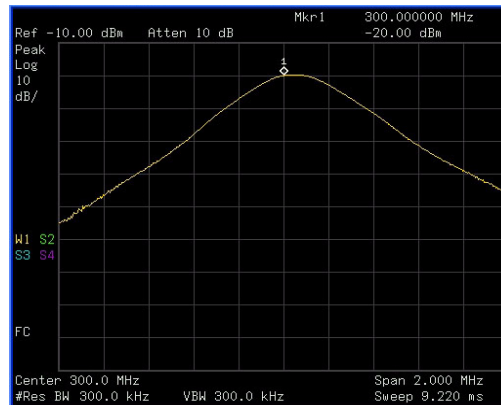

- 4 Change the resolution bandwidth (RBW) to 100 kHz so that the RBW setting is less than or equal to the frequency separation of the two signals:

Press **BW/Avg** > **100** > **kHz**

Notice that the peak of the signal has become flattened indicating that two signals are present.

- 5 Decrease the video bandwidth to 3 kHz:

Press **BW/Avg** > **Video BW** > **3** > **kHz**

Two signals are now visible as shown in Figure 3-6. Use the front-panel knob or arrow keys to further reduce the resolution bandwidth and better resolve the signals.

Decreasing the resolution bandwidth improves the resolution of the individual signals and increases the sweep time.

**Figure 3-6 Resolving Signals of Equal Amplitude**

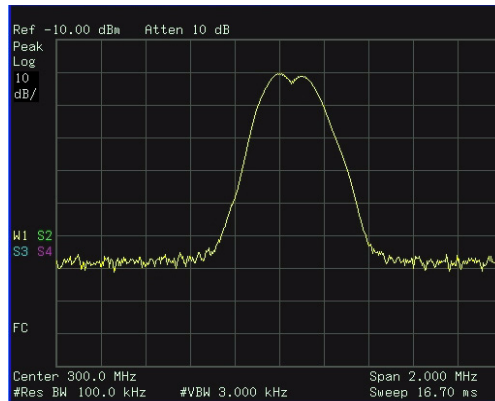

For fastest measurement times, use the widest possible resolution bandwidth. Under factory preset conditions, the resolution bandwidth is coupled to the span.

## Resolving Small Signals Hidden by Large Signals

This example uses narrow resolution bandwidths to resolve two RF signals that have a frequency separation of 50 kHz and an amplitude difference of 60 dB.

- 1 Connect two sources to the **RF IN** as shown in [Figure 3-4](#).
- 2 Set one source to 300 MHz at -10 dBm. Set the other source to 300.05 MHz at -70 dBm.
- 3 Set the analyzer as follows:

Press **Preset/System** > **Preset**. (With **Preset Type** of **Factory**)

Press **Frequency** > **300** > **MHz**

Press **BW/Avg** > **30** > **kHz**

Press **SPAN** > **500** > **kHz**

- 4 Set the 300 MHz signal to the reference level:

Press **Peak Search**

Press **Marker** > **Mkr -> Ref Lvl**

### NOTE

The 30 kHz filter shape factor of 15:1 has a bandwidth of 450 kHz at the 60 dB point. The half-bandwidth (225 kHz) is NOT narrower than the frequency separation of 50 kHz, so the input signals can not be resolved.

**Figure 3-7 Unresolved small signal from large signal**

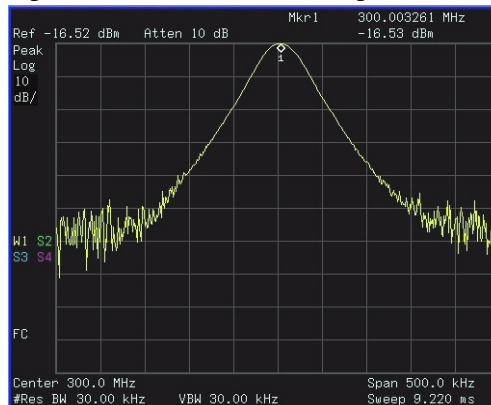

- Reduce the resolution bandwidth filter to view the smaller signal. The smaller signal will be hidden by the larger signal when the bandwidth settings are wider, as in Figure 7. Reducing the RBW setting will allow less of the larger signal to pass through the analyzer and the smaller signals peak will then rise out of the noise floor. Place a delta marker on the smaller signal:

Press **BW/Avg** > **1** > **kHz**

Press **Peak Search**

Press **Marker** > **Delta** > **Delta (On)**

Press **50** > **kHz**

**Figure 3-8 Resolved small signal from large signal**

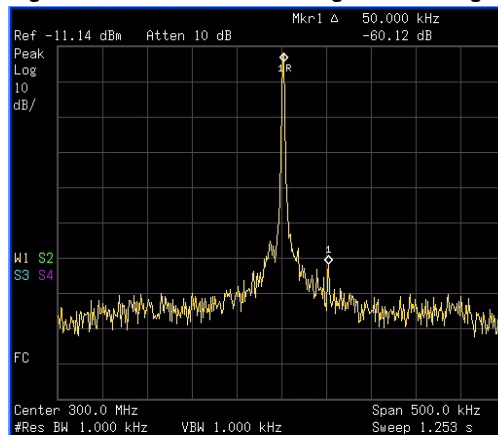

**NOTE**

The 1 kHz filter shape factor of 15:1 has a bandwidth of 15 kHz at the 60 dB point. The half-bandwidth (7.5 kHz) is narrower than the frequency separation of 50 kHz, so the input signals can be resolved.



## Measuring a Low-Level Signal

This section provides information on measuring low-level signals and distinguishing them from spectrum noise.

### Reducing Input Attenuation

The ability to measure a low-level signal is limited by internally generated noise of the spectrum analyzer. The analyzer's input attenuator affects the level of a signal passing through the analyzer. If a signal power level is close to the noise floor, reducing the analyzer input attenuation will help raise the signal so that it can be seen rising out of the noise.

#### CAUTION

Ensure that the total power of all input signals at the analyzer RF input does not exceed +30 dBm (1 Watt).

- 1 Preset the analyzer  
Press **Preset/System** > **Preset** (With **Preset Type** of **Factory**)
  - 2 Set the source frequency to 300 MHz, amplitude to -70 dBm.  
Connect the source **RF OUT** to the analyzer **RF IN**.
- Figure 3-9 Setup for obtaining one signal**

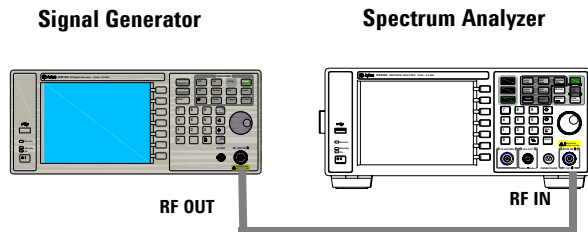

- 3 Set the center frequency, span and reference level:  
Press **Frequency** > **Center Freq** > **300** > **MHz**  
Press **SPAN** > **Span** > **2** > **MHz**  
Press **Amplitude** > **Ref Level** > **40** > **-dBm**.
- 4 Move the desired peak to the center of the display:  
Press **Peak Search**  
Press **Marker** > **Mkr -> CF**
- 5 Reduce the span to 500 kHz, if necessary re-center the peak:  
Press **SPAN** > **500** > **kHz**
- 6 Set the attenuation to 20 dB:  
Press **Amplitude** > **Attenuation** > **20** > **dB**

**Figure 3-10 A signal closer to the noise level**

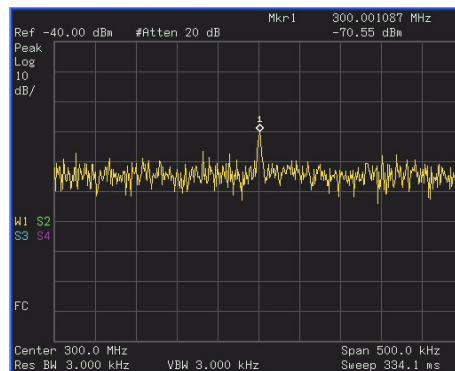

Note that increasing the attenuation moves the noise floor closer to the signal level.

- 7 To allow more of the signal power to pass through the analyzer, decrease the attenuation to 0 dB.

A lower attenuation value will mean that more of the signal strength will be displayed on screen:

Press **Amplitude** > **Attenuation** > **0** > **dB**

**Figure 3-11 Measuring a low-level signal using 0 dB Attenuation**

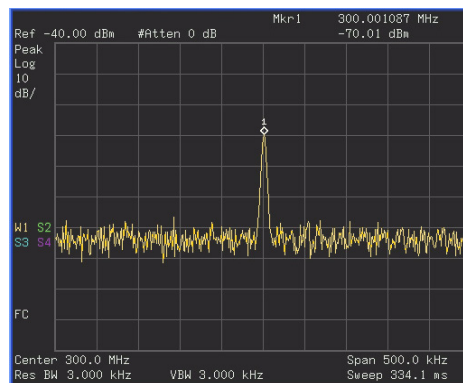

## Decreasing the Resolution Bandwidth

Resolution bandwidth settings affect the level of internal noise but have little effect on the displayed level of continuous wave (CW) signals. Decreasing the RBW by a decade (factor of ten) reduces the noise floor by 10 dB.

- 1 Refer to the procedure “Reducing Input Attenuation” on page 41 and follow steps 1, 2 and 3.
- 2 Decrease the resolution bandwidth:

Press **BW/Avg** and **↓**

The low-level signal appears more clearly due to the noise level being reduced by the decrease in RBW (see [Figure 3-12](#)).

Figure 3-12 Decreasing Resolution Bandwidth

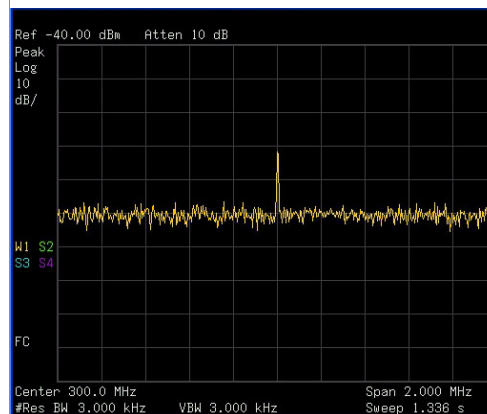

A “#” mark appears next to the Res BW annotation in the lower left corner of the screen, indicating that the resolution bandwidth is uncoupled.

Uncoupled indicates that the function is in manual control mode, not auto control mode. Manual control mode allows the user to change the parameter value for that function without affecting any other settings.

#### NOTE

The analyzer allows you to change the RBW in a 1-3-10 sequence by the data control keys. The RBWs below 1 kHz are digital and have a selectivity ratio of 5:1 while RBWs at 1 kHz and higher have a 15:1 selectivity ratio. The maximum RBW is 3 MHz and minimum is 10 Hz.

## Trace Averaging

Averaging is a digital process in which each sweep of the trace returns measurement values for each point in the trace. These values are then mathematically averaged with the previous sweep trace data which has been stored in the analyzer. The amount of averaging is selected by choosing the number of trace sweeps to be included in the process. The averaging function uses the most recent trace sweep values so that the display shows any signal changes.

Selecting averaging, when the analyzer is auto-coupled, changes the detection mode to **Sample**, smoothing the displayed noise level.

**NOTE**

This is a trace processing function and is not the same as using the average detector (as described on [page 44](#)).

- 1 Refer to the procedure “[Reducing Input Attenuation](#)” on page 41 of this chapter and follow steps 1, 2 and 3.

- 2 To turn averaging on, toggle the softkey menu labeled **Average**:

Press  > **Average (On)**

- 3 Set the number of averages to 20, using the number keypad, up and down arrows, or the knob:

Press **20**, 

The averaging process smooths the viewed trace, low level signals become more visible (see [Figure 3-13](#)). Changes to the average number will restart the averaging process.

**Figure 3-13 Trace Averaging**

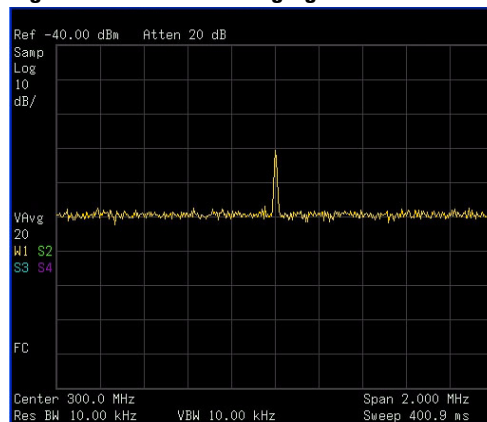

## Improving Frequency Resolution and Accuracy

This section provides information on using the frequency counter function to improve frequency resolution and accuracy.

- 1 Press **Preset/System** > **Preset** (With **Preset Type** of **Factory**)
- 2 Connect a cable from the front panel **CAL OUT** to **RF IN**;  
Press **Preset/System** > **Alignment** > **Align** > **CAL OUT ON** to toggle on and enable the 50 MHz amplitude reference signal.
- 3 Press **Auto Tune** hardkey.

The analyzer will detect the signal peak and locate it to the center of the display screen (Refer to “Auto Tune” on page 89).

- 4 Turn the frequency counter on:  
Press **Marker** > **Function** > **Freq Counter** > **Freq Counter (On)**.
- 5 Move the marker, with the front-panel knob, half-way down the skirt of the signal response.

**Figure 3-14 Using Frequency Counter**

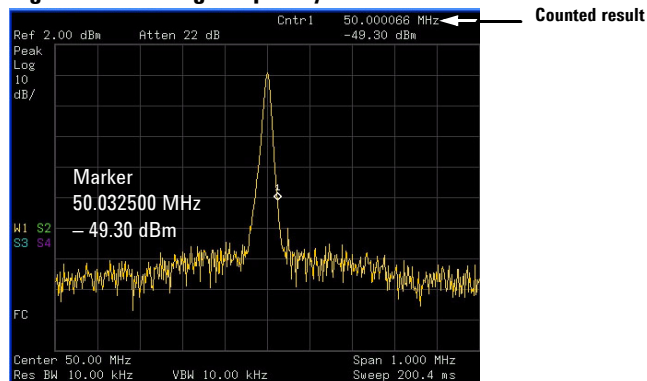

### NOTE

The frequency and amplitude of the marker appears in the active function area (this is not the counted result). The counted result appears in the upper-right corner of the display to the right-side of Cntr1.

The marker readout in the active frequency function changes while the counted frequency result (upper-right corner of display) does not. For an accurate count, the marker need not be placed at the exact peak of the signal response.

**NOTE**

The Frequency counter properly functions only on stable, CW signals or discrete spectral components. The marker power level must be greater than 40 dB above the displayed noise level.

---

- 6** To change the counter resolution:

Press **Marker** > **Function** > **Freq Counter** > **Resolution**

The frequency-counter resolution range is from 1 Hz to 1 kHz, and may be set to Auto or Manual.

- 7** To turn off the marker counter:

Press **Marker** > **Function** > **Freq Counter** > **Freq Counter (Off)**.

**NOTE**

When using the frequency counter function, the ratio of the resolution bandwidth to the span must be greater than 0.02.

---

## Tracking Drifting Signals

This section provides information on measuring and tracking signals that drift in frequency.

### Measuring a Source's Frequency Drift

The analyzer will measure source stability. The maximum amplitude level and the frequency drift of an input signal trace can be displayed and held by using the maximum hold function. Using the maximum hold function you can measure and determine how much of the frequency spectrum a signal occupies. For more information, refer to “Max Hold” on page 158.

Use signal tracking to return a signal drifting in frequency to the center of the display. The drifting is captured by the analyzer using the maximum hold function.

- 1 Connect the signal generator to the analyzer **RF IN**.
- 2 Output a signal with the frequency of 300 MHz and amplitude of -20 dBm.
- 3 Set the analyzer center frequency, span and reference level.

Press  > **Preset**. (With **Preset Type** of **Factory**)

Press  > **Center Freq** > **300** > **MHz**

Press  > **Span** > **10** > **MHz**

Press  > **Ref Level** > **-10** > **dBm**

- 4 Place a marker on the peak of the signal and turn signal tracking on:

Press 

Press  > **Signal Track (On)**

Press  > **1** > **MHz**

Notice that this holds the signal in the center of the display.



- 5 Turn off the signal track function:

Press **Frequency** > **Signal Track (Off)**

- 6 Measure the excursion of the signal with maximum hold:

Press **View/Trace** > **Max Hold**

As the signal varies, maximum hold maintains the maximum responses of the input signal. Annotation on the left side of the screen indicates the trace mode. For example, M1 S2 S3 S4, indicates trace 1 is in maximum-hold mode, trace 2, trace 3, and trace 4 are in store-blank mode.

- 7 Activate trace 2 and change the mode to continuous sweep:

Press **View/Trace** > **Select Trace > Trace 2**

Press **Clear Write**

Trace 1 remains in maximum hold mode to show any drift in the signal.

- 8 Slowly increase the frequency of the signal generator. Your analyzer display should look similar to [Figure 3-15](#).

**Figure 3-15 Viewing a Drifting Signal With Max Hold and Clear Write**

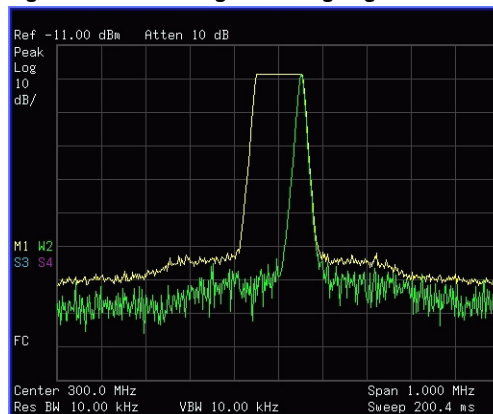

## Making Distortion Measurements

This section provides information on measuring and identifying signal distortion.

### Identifying Analyzer Generated Distortion

High-level input signals may cause analyzer distortion products that could mask the real distortion measured on the input signal. Use trace and the RF input attenuator to determine which signals, if any, are internally generated distortion products.

In this example, we use the RF output of a signal generator to determine whether the harmonic distortion products are internally generated by the analyzer.

- 1 Connect the signal generator to the analyzer **RF IN**.
- 2 Set the source frequency to 200 MHz, amplitude to 0 dBm.
- 3 Set the analyzer center frequency and span:

Press **Preset/System** > **Preset**

Press **Frequency** > **400** > **MHz**

Press **SPAN** > **500** > **MHz**

**Figure 3-16 Harmonic Distortion**

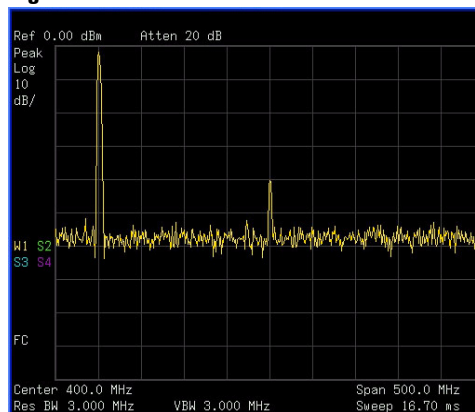

The signal produces harmonic products (spaced 200 MHz from the original 200 MHz signal) in the analyzer input mixer as shown in [Figure 3-16](#).

- 4 Change the center frequency to the value of the first harmonic:

Press  > **Next Peak**

Press  > **Mkr -> CF**

- 5 Change the span to 50 MHz and re-center the signal:

Press  > **50 > MHz**

Press 

Press  > **Mkr -> CF**

- 6 Set the attenuation to 0 dB:

Press  > **Attenuation > 0 > dB**

- 7 To determine whether the analyzer generates harmonic distortion products, first display the trace data in trace 2 as follows:

Press  > **Select Trace > Trace 2**

Press **Clear Write**

- 8 Allow trace 2 to update (minimum two sweeps), then store the data from trace 2 and place a delta marker on the harmonic of trace 2:

Press  > **View**

Press 

Press  > **Delta > Delta (On)**

The analyzer display shows the stored data in trace 2 and the measured data in trace 1. The **Marker $\Delta$**  indicator reads the difference in amplitude between the reference and active markers.

- 9 Increase the RF attenuation to 10 dB:

Press  > **Attenuation > 10 > dB**

Notice the **Marker $\Delta$**  amplitude readout. This is the difference of the distortion product amplitude between 0 dB and 10 dB input attenuation settings. If the **Marker $\Delta$**  absolute amplitude is approximately  $\geq 1$  dB for an input attenuator change, the analyzer is generating, at least in part, the distortion.

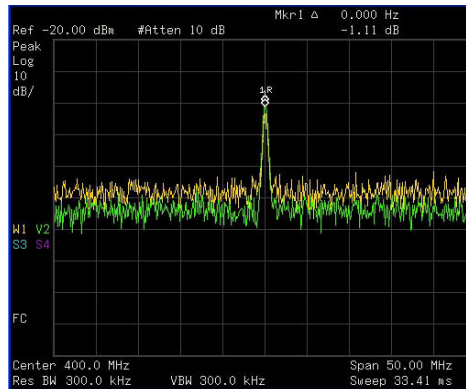

The **Marker $\Delta$**  amplitude readout comes from two sources:

- 1) Increased input attenuation causes poorer signal-to-noise ratio. This causes the **Marker $\Delta$**  to be positive.
- 2) The reduced contribution of the analyzer circuits to the harmonic measurement causes the **Marker $\Delta$**  to be negative.

Large **Marker $\Delta$**  readout indicates significant measurement errors. Set the input attenuator to minimize the absolute value of **Marker $\Delta$** .

## Third-Order Intermodulation Distortion

Two-tone, third-order intermodulation distortion is a common specification in communication systems. When two signals are present in a non-linear system, they may interact and create third-order intermodulation distortion (TOI) products that are located close to the original signals. System components such as amplifiers and mixers contribute to the generation of these distortion products.

For an example of the quick setup of TOI measurement, refer to “[Intermod \(TOI\)](#)” on page 124.





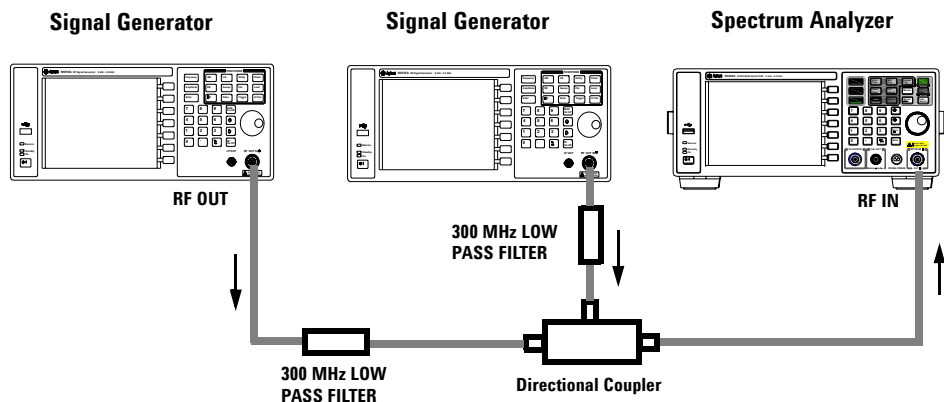







This example will test a device for third-order intermodulation through the use of markers. Two sources are used, one set to 300 MHz and the other to 301 MHz.

- 1 Connect the equipment as shown in figure below. This combination of signal generators, low pass filters, and directional coupler (used as a combiner) results in a two-tone source with very low intermodulation distortion. Although the distortion from this setup may be better than the specified performance of the analyzer, it is useful for determining the TOI performance of the source/analyzer combination. After the performance of the source/analyzer combination has been verified, the device-under-test (DUT) (for example, an amplifier) would be inserted between the directional coupler output and the analyzer input.



**NOTE**

The coupler should have a high degree of isolation between the two input ports so the sources do not intermodulate.

- 2 Set one source (signal generator) to 300 MHz and the other source to 301 MHz, for a frequency separation of 1 MHz. Set the sources equal in amplitude as measured by the analyzer (in this example, they are set to -5 dBm).
- 3 Set the analyzer center frequency and span:
  - Press  > **Preset** (With **Preset Type** of **Factory**)
  - Press  > **Center Freq** > **300.5** > **MHz**
  - Press  > **5** > **MHz**
- 4 Reduce the RBW until the distortion products are visible:
  - Press  and 
- 5 Move the signal to the reference level:
  - Press 
  - Press  > **Mkr -> Ref Lvl**
- 6 Reduce the RBW until the distortion products are visible:
  - Press  and 
- 7 Activate the second marker and place it on the peak of the distortion product (beside the test signal) using the **Next Peak**:
  - Press  > **Delta** > **Delta (On)**
  - Press  > **Next Peak**
- 8 Measure the other distortion product:
  - Press  > **Normal**
  - Press  > **Next Peak**

9 Measure the difference between this test signal and the second distortion product (see Figure 3-17):

Press **Marker** > **Delta** > **Delta (On)**

Press **Peak Search** > **Next Peak**

Figure 3-17 Measuring the Distortion Product

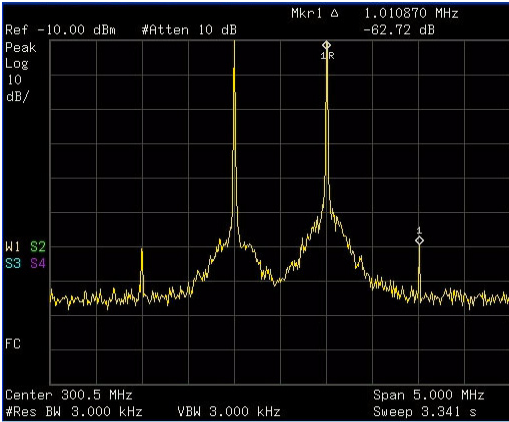

## Measuring Phase Noise

Phase noise is a frequency domain measure of stability. Phase noise is specified as single-sideband power in relation to the fundamental RF output frequency. It is measured at various offset frequencies from the carrier, normalized to a 1 Hz measuring bandwidth.

In this example the 50 MHz amplitude reference signal is used as the fundamental signal.

- 1 Press **Preset/System** > **Preset** (With **Preset Type** of **Factory**)
- 2 Connect a cable from the front panel **CAL OUT** to **RF IN**.  
Press **Preset/System** > **Alignment** > **CAL OUT On**
- 3 Press **Auto Tune** to auto-tune the signal to the center of display.
- 4 Press **Peak Search** to place a marker on the peak of the signal.
- 5 Turn on the phase noise function to view the results:  
Press **Marker** > **Function** > **Phase Noise** > **Phase Noise (On)**
- 6 Change the offset:  
Press **Marker** > **Function** > **Phase Noise** > **Offset Manual**

Then select the offset by pressing the corresponding softkeys under the **Phase Noise** menu.

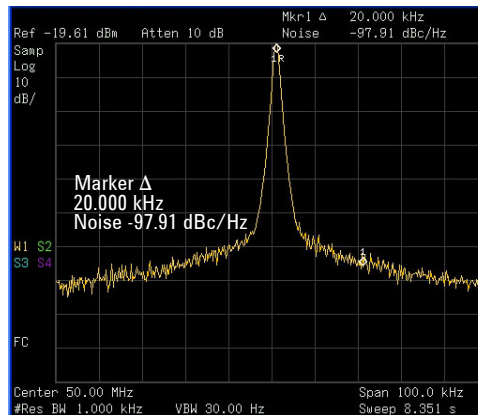



## Stimulus Response Transmission

The procedure below describes using the built-in tracking generator of the analyzer to measure the rejection of a low pass filter. A type of transmission measurement.

- 1 To measure the rejection of a low pass filter, connect the equipment as shown in Figure 3-18. A 370 MHz low pass filter as the DUT.

**Figure 3-18 Transmission Measurement Test Setup**

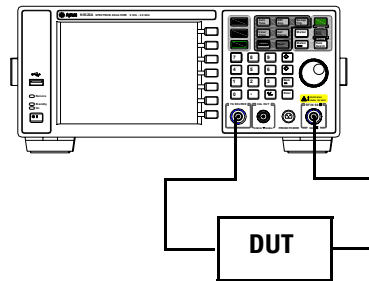

- 2 Press **Preset/System** > **Preset**. (With **Preset Type** of **Factory**)
- 3 Set the start and stop frequencies and resolution bandwidth:  
 Press **Frequency** > **Start Freq** > **100** > **MHz**  
 Press **Frequency** > **Stop Freq** > **1** > **GHz**  
 Press **BW/Avg** > **Res Bw** > **3** > **MHz**
- 4 Turn on the tracking generator and if necessary, set the output power to -10 dBm:  
 Press **MODE** > **Tracking Generator** > **Amplitude TG (On)** > **-10** > **dBm**

### CAUTION

Excessive signal input may damage the DUT. Do not exceed the maximum power that the device under test can tolerate.

#### NOTE

To reduce ripples caused by source return loss, use 6 dB or greater output attenuation. Tracking generator output attenuation is normally a function of the source power selected. However, the output attenuation may be controlled in the Tracking Generator menu.

- 5 To increase measurement sensitivity and smooth the noise:

Press **BW/Avg** > **Res Bw** > **30** > **KHz**

Press **BW/Avg** > **Video Bw** > **300** > **KHz**

A decrease in displayed amplitude is caused by tracking error.

- 6 Use peak tracking to correct the frequency offset:

Press **MODE** > **Tracking Generator** > **More** > **Tracking Peak**

Tracking error occurs when the output frequency of the tracking generator is not matched to the input frequency of the analyzer. The amplitude should return to the value that was displayed prior to the decrease in resolution bandwidth.

- 7 Connect the cable from the tracking generator output to the analyzer input. Store the frequency response in trace 3 and normalize:

Press **MODE** > **Tracking Generator** > **More** > **Normalize** > **Store Ref (1 → 3)** > **Normalize (On)**

- 8 Reconnect the DUT to the analyzer and change the normalized reference position:

Press **MODE** > **Tracking Generator** > **More** > **Normalize** > **Norm Ref Posn** > **8**

- 9 Measure the rejection of the low pass filter:  
Press **Marker** > **Normal** > **370** > **MHz, Delta** > **160** > **MHz**

The marker readout displays the rejection of the filter at 160 MHz above the cutoff frequency of the low pass filter. See [Figure 3-19](#) as below.

**Figure 3-19 Measure the Rejection Range**

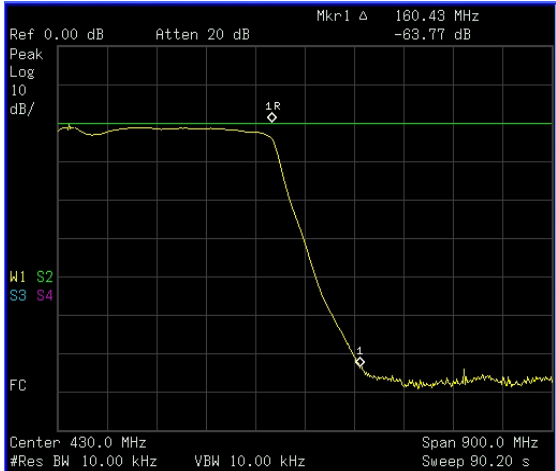

## Measuring Stop Band Attenuation of a Lowpass Filter

When measuring filter performance, it is useful to look at the stimulus response over a wide frequency range. Setting the analyzer y-axis (amplitude) to Log scale type presents the measurement data in a usable format for determining filter characteristics.

The following example uses the tracking generator to measure the stop band attenuation of a 370 MHz low pass filter.

- 1 To measure the response of a low pass filter, connect the equipment as shown in [Figure 3-20](#). This example uses a 370 MHz low pass filter.

**Figure 3-20 Transmission Measurement Test Setup**

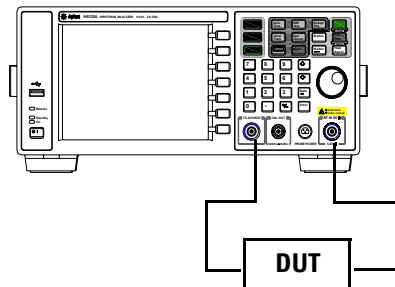

- 2 Press **Preset/System** > **Preset**. (With **Preset Type** of **Factory**)
- 3 Set the start and stop frequencies and resolution bandwidth:
  - Press **Frequency** > **Start Freq** > **100** > **MHz**
  - Press **Frequency** > **Stop Freq** > **1** > **GHz**
  - Press **Amplitude** > **Scale Type** > **Log**

- 4 Set the resolution bandwidth to 10 kHz:

Press **BW/Avg** > **Res Bw** > **10** > **KHz**

**CAUTION**

Excessive signal input may damage the DUT. Do not exceed the maximum power that the device under test can tolerate.

- 5 Turn on the tracking generator and, if necessary, set the output power to -10 dBm:

Press **MODE** > **Tracking Generator** > **Amplitude TG (On)** > **-10** > **dBm**

- 6 Connect the test cable (but not the DUT) from the tracking generator output to the analyzer input. Store the frequency response into trace 3 and normalize:

Press **MODE** > **Tracking Generator** > **More** > **Normalize** > **Store Ref (1 → 3)** > **Normalize (On)**

- 7 Reconnect the DUT to the analyzer. Note that the units of the reference level have changed to dB, indicating that this is now a relative measurement.

- 8 To change the normalized reference position:

Press **MODE** > **Tracking Generator** > **More** > **Normalize** > **Norm Ref Posn** > **8**

- 9 Place the reference marker at the specified cutoff frequency:

Press **Marker** > **Delta Pair (Ref)** > **370** > **MHz**

- 10 Place the second marker at 37 MHz:

Press **Marker** > **Delta Pair (Delta)** > **37** > **MHz**

- 11 In this example, the attenuation over this frequency range is -17.98 dB/octave (one octave above the cutoff frequency).
- 12 Use the front-panel knob to place the marker at the highest peak in the stop band to determine the minimum stop band attenuation. In this example, the peak occurs with Delta of 563 MHz. The attenuation is -60.93 dB. See Figure 3-21.

Figure 3-21 Minimum Stop Band Attenuation

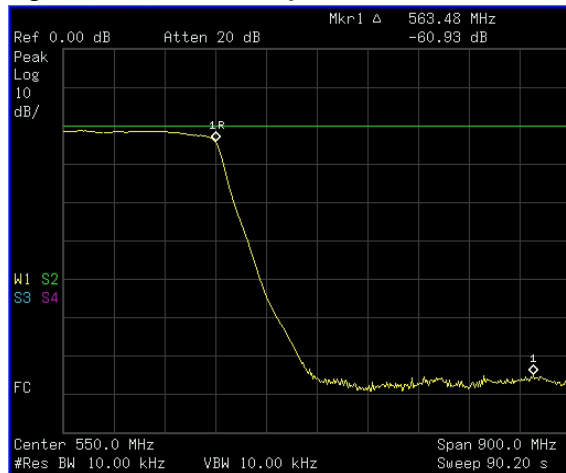

## Making a Reflection Calibration Measurement

The following procedure makes a reflection measurement using a coupler or directional bridge to measure the return loss of a filter. This example uses a 370 MHz low pass filter as the DUT.

The calibration standard for reflection measurements is usually a short circuit connected at the reference plane (the point at which the device under test (DUT) is connected.) See [Figure 3-22](#), a short circuit has a reflection coefficient of 1 (0 dB return loss). It reflects all incident power and provides a convenient 0 dB reference.

- 1 Connect the DUT to the directional bridge or coupler as shown in [Figure 3-22](#). Terminate the unconnected port of the DUT.

**Figure 3-22 Reflection Measurement Short Calibration Test Setup**

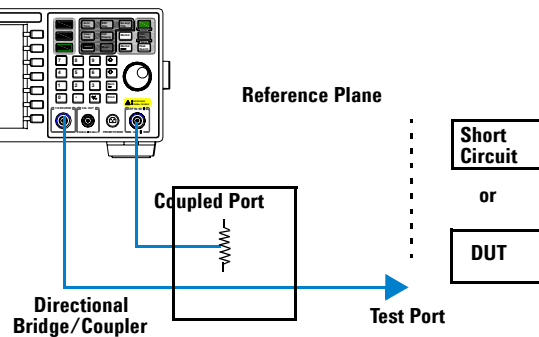

#### NOTE

For greatest accuracy, use a coupler or bridge with the correct test port connector. Any additional adapters or components placed between the test port and DUT degrades coupler/bridge directivity and system source match.

For best results, use the same adapter for the calibration and the measurement. Be sure to terminate the second port of a two port device.

- 2 Connect the tracking generator output of the analyzer to the directional bridge or coupler.
- 3 Connect the analyzer RF input to the coupled port of the directional bridge or coupler.
- 4 Press **Preset/System** > **Preset**. (With **Preset Type** of **Factory**)
- 5 Turn on the tracking generator and, if necessary, set the output power to -10 dBm:

Press **MODE** > **Tracking Generator** > **Amplitude TG (On)** > **-10** > **dBm**

#### CAUTION

Excessive signal input may damage the DUT. Do not exceed the maximum power that the device under test can tolerate.

- 6 Set the start and stop frequencies and resolution bandwidth:  
Press **Frequency** > **Start Freq** > **100** > **MHz**  
Press **Frequency** > **Stop Freq** > **1** > **GHz**  
Press **BW/Avg** > **Res Bw** > **3** > **MHz**
- 7 Replace the DUT with a short circuit.



8 Normalize the trace:

Press **MODE** > **Tracking Generator** > **More** > **Normalize** > **Store Ref (1 → 3)** > **Normalize (On)**

This activates the trace 1 minus trace 3 function and displays the results in trace 1 (Figure 3-23). The normalized trace or flat line represents 0 dB return loss. Normalization occurs each sweep. Replace the short circuit with the DUT.

**NOTE**

The reference trace is stored in trace 3, changing trace 3 to Clear Write will invalidate the normalization.

**Figure 3-23 Short Circuit Normalized**

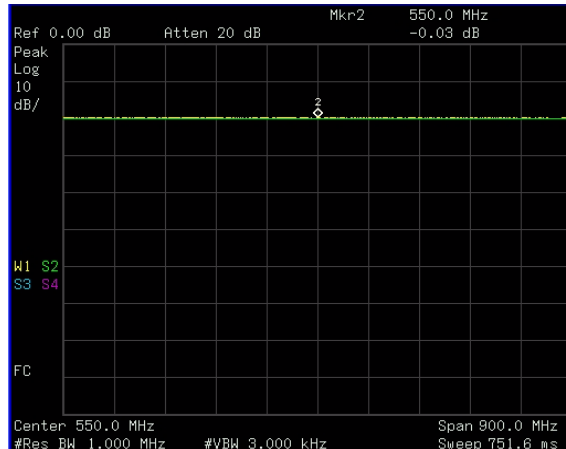

## Measuring Return Loss Using the Reflection Calibration Routine

This procedure uses the reflection calibration routine in the preceding procedure “[Making a Reflection Calibration Measurement](#)” on page 63 to calculate the return loss of the 370 MHz low pass filter.

- 1 After calibrating the system with the above procedure, reconnect the filter (DUT) in place of the short circuit used for calibration. Do not change any of the analyzer settings or the measurement setup may be invalidated.
- 2 Use the marker to read return loss. Position the marker with the front-panel knob to read the return loss at that frequency.

Rotate the knob to find the highest peak and the readout is the maximum return loss. See [Figure 3-24](#).

**Figure 3-24 Measuring the Return Loss of the Filter**

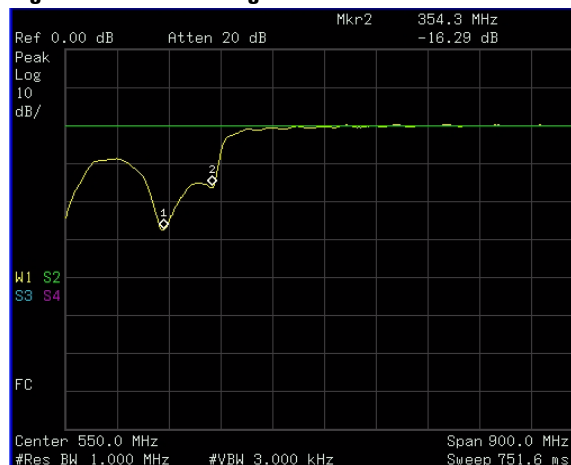

## Making an Average Power Measurement

Average power measurements provide a key metric in transmitter performance.

Base station transmit power must be set accurately to achieve optimal coverage in wireless networks. If the transmit power is set too high due to inaccurate power measurements, undesired interference can occur. If the transmit power is set too low, coverage gaps or holes may occur. Either case affects system capacity and may translate into decreased revenue for service providers. Average power can be measured for the channel of interest while the base station is active. All other channels should be inactive. Average power is a broadband measurement. If other signals are present the analyzer will also measure their power contributions.

### CAUTION

The maximum power for the RF IN port and the RF OUT port of the analyzer is +30 dBm (1 W). The maximum power for the U2000 Series Power Sensor port is +25 dBm (316 mW). When directly coupled to a base station, the test set can be damaged by excessive power applied to any of these three ports.

To prevent damage in most situations when directly coupling an analyzer to a base station, use a high power attenuator between the analyzer and the BTS.

---

The N9320B spectrum analyzer supports the U2000 Series USB power sensors.

The U2000 Series USB power sensors do not need manual calibration and zero routines performed. Calibration and zeroing are performed without removing the power sensor from the source, through internal zeroing. With internal zeroing of U2000 Series USB power sensors, there is no need

to disconnect the sensor or power-off the DUT. The U2000 Series do not require 50 MHz reference signal calibration, allowing the factory calibration to ensure measurement

accuracy. For best accuracy, users are recommended to perform external zeroing for input signals below -30 dBm for best accuracy.

**NOTE**

If you suspect other signals may be present, it is recommended that you turn off all the other channels and measure average power only on the signal of interest. Another option is to measure channel power (which is less accurate), that filters out all other channels (signals).

**NOTE**

Connect the power meter as close as possible to the power amplifier/duplexer output. Do not use a coupled port. Sensors may not be as accurate at the power levels provided by coupled ports.

## Making a Basic Average Power Measurement

To make an average power measurement, you connect the power sensor and cable, zero and calibrate the meter, before making a measurement. Zeroing of the power meter will occur automatically:

- Every time you use the Power Meter.
- When a 5 degree C. change in temperature occurs.
- Whenever you change the power sensor.
- Every 24 hours.
- Before measuring low level signals—for example, 10 dB above the lowest specified power for your power sensor.

Calibrating the power meter every time you cycle the power on and off.

In most situations, you can press **{Zero}** to complete the two steps (zero and cal) together.

### To Make a Basic Average Power Measurement

Follow the steps below to make a basic average power measurement.

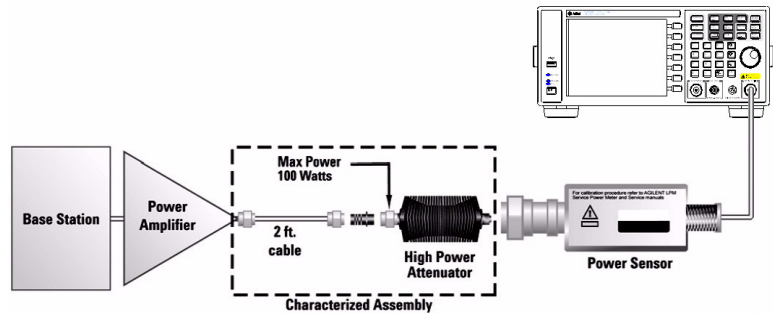

- 1 Press **Preset/System** > **Preset**. (With **Preset Type** of **Factory**)
- 2 Press **MODE**, rotate the knob or press the arrow hardkey to highlight **Power Meter**, then press **[ENTER]** to turn on the power meter.
- 3 Zero and calibrate the meter. Press **{Zero}** to make a Zero operation of the power sensor followed by a calibration operation.
- 4 Connect the power sensor to the power Ref 50 MHz port. The analyzer supports the U2000 Series power sensors.
- 5 Connect the external attenuation, if required, with the power sensor used.
- 6 Connect the analyzer to the base station. Connect the power sensor to the signal to be measured. A typical BTS connection is after the output of the power amplifier and duplexer. The connection requires a 2 ft. cable and two Type-N barrel connectors, in addition to the power sensor and external attenuator.

**Figure 3-25 Connection with base station**





### Setting Power Meter Resolution

You can choose from four levels of Power Meter resolution. Higher resolutions provide more accuracy but slow the measurement speed.

- 1 Press  > **Preset**. (With **Preset Type** of **Factory**)
- 2 Press , rotate the knob or press the arrow hardkey to highlight **Power Meter**, then press **[ENTER]** to turn on the power meter.
- 3 Press **{Meas Disp}** > **{Resolution}**. Select 1,2,3 or 4. The four options represent different resolution as follow:
  - [1] = 1
  - [2] = 0.1
  - [3] = 0.01
  - [4] = 0.001

### Setting the Power Meter.s Top and Bottom End-Points

Setting the end points (Disk Range) close to expected measurement value changes the sensitivity of the Power Meter scale resolution. This is an advantage in viewing small changes in power. However, this will not affect the overall range of the sensor.

- 1 Press  > **Preset**. (With **Preset Type** of **Factory**)
- 2 Press , rotate the knob or press the arrow hardkey to highlight **Power Meter**, then press **[ENTER]** to turn on the power meter.
- 3 Press **{Meas Disp}** > **{Dis Range}** to access the end-points menu.
- 4 Press **{Top}** and enter the maximum scale value using the numeric keypad. Then press **{dBm}** to complete the setup.
- 5 Press **{Bottom}** and enter the minimum scale value desired using the numeric keypad. Then press **{dBm}** to complete the setup.

## Demodulate the AM/FM signal

The N9320B provide you the AM/FM demodulation function.

### Demodulating an AM Signal

The demodulation functions listed in the menu under **SPAN** > **{Demod}** allow you to demodulate and hear signal information displayed on the analyzer.

Simply place a marker on a signal of interest, set the analyzer in zero span, activate AM demodulation, turn the speaker on, and then listen.

- 1 Press **Preset/ System** > **Preset**. (With **Preset Type** of **Factory**)
- 2 Connect an antenna to the analyzer input.
- 3 Select a frequency range on the analyzer, such as the range for AM radio broadcasts. For example, the frequency range for AM broadcasts in the United States is 550 kHz to 1650 kHz:  
Press **Frequency** > **{Start Freq}** > **550** > **{kHz}** > **{Stop Freq}** > **1650** > **{kHz}**.
- 4 Place a marker on the signal of interest:  
Press **Peak Search** > **{Next Pk Right}** or **{Next Pk Left}**
- 5 Set the frequency of interest to center frequency:  
Press **Peak Search** > **{Next Pk Right}** or **{Next Pk Left}** (as necessary).
- 6 Change the resolution bandwidth to 100 kHz:  
Press **BW/ Avg** > **100** > **{kHz}**.
- 7 Press **SPAN** > **{Zero Span}**.
- 8 Set the detector type and turn on AM demodulation:  
Press **Det/ Display** > **{Detector}** > **{Sample}**.  
Press **SPAN** > **{Demod}** > **{AM ON}**.

## Demodulating an FM Signal

This section demonstrates how to demodulate and listen to an FM signal using the built-in FM demodulator.

Using the built in FM demodulator you can tune to an FM signal and view the results of the detector output as displayed in the time-domain.

- 1 Press **Preset/System** > **Preset**. (With **Preset Type** of **Factory**)
- 2 Use a signal source or an antenna for an FM signal to analyze. In this example the signal source is used transmitting at 300 MHz with FM deviation of 10 kHz and FM rate of 1 kHz.

### NOTE

If you are using a broadcast FM signal in the United States, for example, the FM channels are broadcasting between 87.7 MHz to 107.7 MHz.

- 3 Set the center frequency to the center of the FM signal (in this case 300 MHz):  
Press **Frequency** > **300** > **{MHz}**.
- 4 Set the analyzer to zero span for time-domain analysis:  
Press **SPAN** > **{Zero Span}**.  
Press **Sweep/Trig** > **{Sweep Time}** > **5** > **{s}**.  
Press **Peak Search** > **{Next Pk Right}** or **{Next Pk Left}**
- 5 Set the resolution bandwidth to capture the full bandwidth of the FM signal.  
Press **BW/Avg** > **100** > **{kHz}**.
- 6 Turn on the pre-amplifier to observe the small signal:  
Press **Amplitude** > **{Int Preamp On}**.



**7** Turn on the FM demodulator:

Press **SPAN** > **{Demod}** > **{FM ON}**.

Listen to the FM signal.

Press **SPAN** > **{Demod}** > **{Speaker Vol}**, rotate the knob to adjust the speaker volume.

The headphone jack is available for the audio signal output alternatively.

## Analysis the Modulated Signals

The N9340B provides the optional AM/FM (Option AMA) and ASK/FSK (Option-DMA) modulation analysis function for analysis the modulated signals. These functions can be activated by license key.

### AM/FM Modulation Analysis

Optional AM/FM demodulation analysis provides modulation metrics, including carrier power, modulation rate, AM depth/FM deviation, SINAD and carrier frequency offset. User definable limits provide Pass/Fail indicators of four types:

Maximum carrier power, Maximum AM modulation index or FM deviation, Minimum AM modulation index or FM deviation, and Minimum carrier frequency offset.

The user can save the waveforms with metrics for reporting as well as the set-up parameters for future measurements or analysis. In the following example, you can use any source available (such as AM/FM radio) as long as it has AM/FM signal generation capability.

#### AM Modulation Analysis

Please refer to the procedures below for the AM modulation analysis:

- 1 Connect the signal generator to RF IN connector and turn on the signal generator's AM and RF output.
- 2 Turn on the AM demodulation analysis function.  
Press **[MODE]**, Rotating the knob to highlight **AM modulation Analysis**, press **[ENTER]**.
- 3 Press **{Carries Freq} > [500] > {MHz}** to set the carrier frequency.

4 Set the attenuation state to Auto (default):

Press {More} > {More} > {Attenuation Auto} > {More}

5 Press {Y Scale} > {Auto Scale} > {Return} to set the Y scale.

6 Set the AM depth limit and turn on the limit function:

Press {More} > {Limits} > {AM Depth UP} > [76] > {%} > {AM Depth Low} > [70] > {%} > {Limits on}

The red value in the result indicates the demodulated AM depth exceeds the limits set as above.

Figure 3-26 AM demodulation analysis

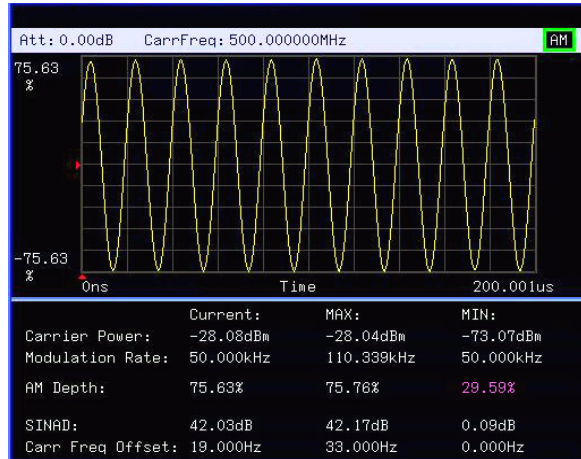

### FM Modulation Analysis

Please refer to the procedures below for the FM modulation analysis:

1 Connect the signal generator to RF IN connector and turn on the signal generator's FM and RF output.

2 Turn on the FM demodulation analysis function.

Press [MODE], rotating the knob to highlight **FM modulation Analysis**, press [ENTER].

3 Press {Carries Freq} > [1.5] > {GHz} to set the carrier frequency.

4 Set the attenuation state to Auto (default):

Press **{More}** > **{More}** > **{Attenuation Auto}** > **{More}**

5 Press **{Y Scale}** > **{Auto Scale}** > **{Return}** to set the Y scale.

6 Set the FM deviation limit and turn on the limit function:

Press **{More}** > **{Limits}** > **{FreqDev UP}** > **[60]** > **{%}** > **{FreqDev Low}** > **[30]** > **{%}** > **{Limits on}** > **{Return}**

The purple value in the result indicates the demodulated FM deviation exceeds the limits set as above.

**Figure 3-27 FM modulation analysis**

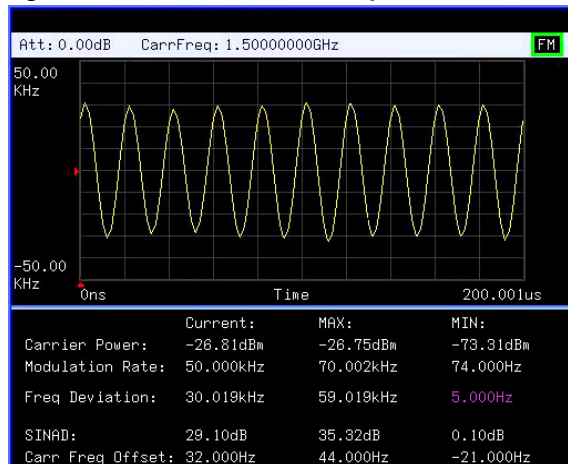

## ASK/FSK Modulation Analysis

The ASK/FSK modulation analysis function supports four display modes:

- Symbol
- Waveform
- ASK/FSK Error
- Eye Diagram.

User definable limits provide Pass/Fail indicators of four types:

- Maximum carrier power
- Maximum ASK modulation depth/FSK frequency deviation
- Minimum ASK modulation depth/FSK frequency deviation
- Maximum carrier frequency offset.

The metrics includes carrier power, ASK/FSK error, ASK depth/FSK frequency deviation, and ASK index etc. The waveform with metrics and setup parameters can be saved for reports and future Measurements.

In the following example, you can use any source available (such as your remote key of the car) as long as it has ASK/FSK generation capability. For ASK/FSK signal, its Filter is Nyquist and Alpha is 0.35.

### ASK Modulation Analysis

Please refer to the procedures below to analysis the ASK demodulation.

- 1 Connect the signal generator to RF IN connector and turn on the signal generator's ASK and RF output.
- 2 Turn on the ASK demodulation analysis function.  
Press **[MODE]**, rotating the knob to highlight **ASK modulation Analysis**, press **[ENTER]**.
- 3 Press **{Carriers Freq} > [100] > {MHz}** to set the carrier frequency.

- 4 Press **{Symbol Rate}** > **[10]** > **{MHz}** to set the symbol rate.
- 5 Press **{Filter Setup}** > **{Ref Filter}** > **{Nyquist}** > **{Return}** to set the filter type.
- 6 Set the attenuation state to Auto (default):  
Press **{More}** > **{More}** > **{Attenuation Auto}** > **{More}**
- 7 Press **{Y Scale}** > **{Auto Scale}** > **{Return}** to set the Y scale.
- 8 Setting the ASK depth limit and turn on the limit function:  
Press **{More}** > **{Limits}** > **{ASK Depth UP}** > **[71]** > **{%}** > **{ASK Depth Low}** > **[70]** > **{%}** > **{Limits on}** > **{Return}**
- 9 Press **{More}** > **{More}** > **{View}** > **{Eye Diagram}** to view the eye diagram.

#### FSK Demodulation Analysis

Please refer to the procedures below to analysis the FSK demodulation.

- 1 Connect the signal generator to RF IN connector and turn on the signal generator's FSK and RF output.
- 2 Turn on the ASK demodulation analysis function.  
Press **[MODE]**, Rotating the knob to highlight ***FSK modulation Analysis***, press **[ENTER]**.
- 3 Press **{Carries Freq}** > **[1.5]** > **{GHz}** to set the carrier frequency.
- 4 Press **{Symbol Rate}** > **[10]** > **{ksps}** to set the symbol rate.
- 5 Press **{Filter Setup}** > **{Ref Filter}** > **{Nyquist}** > **{Return}** to set the filter type.
- 6 Set the attenuation state to Auto (default):  
Press **{More}** > **{More}** > **{Attenuation Auto}** > **{More}**
- 7 Press **{Y Scale}** > **{Auto Scale}** > **{Return}** to set the Y scale.

8 Setting the FSK deviation limit and turn on the limit function:

Press {More} > {Limits} > {FreqDev UP} > [85] > {kHz} > {FreqDev Low} > [80] > {kHz} > {Limits on}

The figure below indicates the FSK EYE Diagram as a measurement result.

Figure 3-28 FSK Eye Diagram

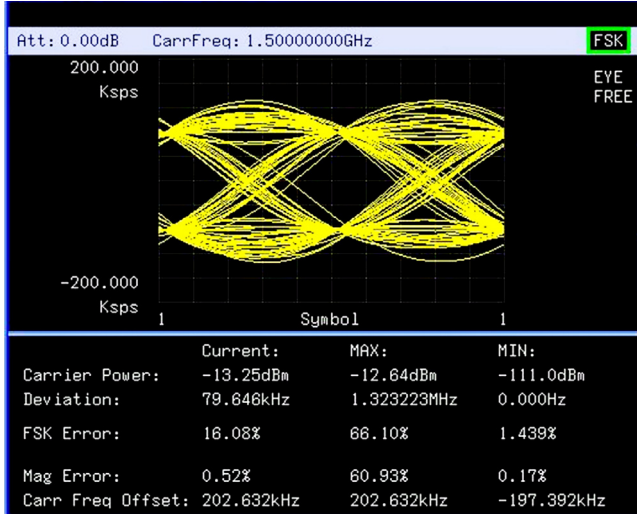

## Viewing Catalogs and Saving Files

The analyzer will store and retrieve data files similar to using a PC. The analyzer allows you to view and save files in the internal storage of the analyzer or to a USB storage device. This section provides information on how to locate catalogs (file types) and to save files.

### Locating and Viewing Files in the Catalog

The analyzer has four types of files:

- State** stores analyzer settings (file extension: .STA).
- Trace** stores trace information (file extension: .TRA).
- Screen** stores screen captures of the display (file extension: .JPG).
- Limits** which stores data sets to determine whether a trace has exceeded preset specifications (file extension: .LIM).

#### NOTE

Trace files are not bitmap files. They cannot be imported into other applications or converted. If you require the use of other applications, be sure to save as .JPG formats using **Screen** for your file type.

Press  > **Catalog** to bring up a screen display below.

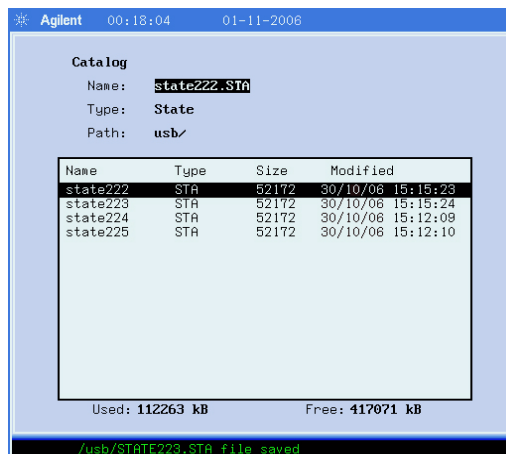



- 1 The entry fields show the parameters for the files viewed:
  - Name** states the filename.
  - Type** displays the type of files viewed.
  - Path** displays the location of the files (Local or USB).
- 2 There are four column headings in this area of the display:
  - Name** displays the filename.
  - Type** displays the filename extension (TRA, STA, TRC or JPG).
  - Size** displays the size of the file in bytes.
  - Modified** displays the date and time the change occurred.
- 3 The softkey menu has four options:
  - Type** selects the type of file you wish to view.
  - Sort** sorts and views the files according to a file attribute.
  - Local** accesses the internal storage to view files.
  - USB** accesses the external USB storage device to view files.
- 4 The drive space line shows the number of bytes used on the drive and the number of bytes still free on the drive.

## Saving a File

The analyzer can save files (states, traces, limits or screens) to a USB storage device (**USB/**), or internal storage (**Local/**). The following is an example of how to save a trace to internal storage (**Local/**).

- 1 Select the save destination for the file. This example will select the internal storage (**Local/**):  
Press  > **Catalog** > **Local**
- 2 Press **Return** > **Save**, to access the **Save** menu.
- 3 Select the type of file. In this example we will save a trace. The filename extension for the trace file type is .TRA:  
Press **Type** > **Trace**

- 4 Select the trace to save (1, 2, 3, 4 or all traces). For this example, we will select trace 3:

Press **Source > Trace 3**

- 5 Enter a filename by pressing **Name**. Assume you name the file “TEST1”. The alpha portion of the filename is selected using the softkey menus. The numeric keypad is used for the numeric portion of the filename. Press **Enter** to accept the filename and to terminate this process and return to the **Save** menu.

The filename can be composed of alpha (A-Z) or numeric (0-9) characters in any combination. The analyzer will not overwrite an existing file. If the filename already exists, the status bar will display the message: “File already exists”. If a filename is not edited, the analyzer will automatically generate a name based on the type of file you are saving (State: STATE, Trace: TRACE, Limits: LIMIT, Screen: SCREN). It also generates a three digit integer, starting at 000 and extending through 999, which it adds to the name, for example: TRACE056.TRC. The analyzer will remember the previously saved value even through a power cycle.

- 6 Press **Save Now** to save the file.

“Saving Now” is displayed during this operation. In this example, the status bar displays “Local/TEST1.TRC file saved”.

#### CAUTION

When saving a file to a USB storage device, do not disconnect the USB device during the save operation. To do so may cause unexpected data loss.

---

## Loading a File

This feature will recall (load) onto the displayed screen a previously saved filename and type compatible with this analyzer. The file types are described above.

- 1 Select the directory where your file is located. In this example, select the internal storage (Local/):  
Press  > **Catalog > Local**
- 2 Press **Return > Load** to access the **Load** menu
- 3 Select the type of file. Assume you need to load a trace file:  
Press **Type > Trace**
- 4 Using the knob or arrow keys to highlight the file you need. And then select the trace into which you wish to load the file. Assume you need to load file TEST1.TRC into Trace 2:  
Press **Destination > Trace 2.**
- 5 Press **Load Now** to load the specified file. The status bar displays: "Local/TEST1.TRC file loaded".  
Screen files are in .jpg format and cannot be loaded or recalled into the analyzer display, they can only be downloaded and used in PC applications.

## Copying a File

To copy a file from internal storage to a USB storage device, follow this procedure:

- 1 Press  > **Catalog** > **Local** to select the path.
- 2 Connect a USB storage device to the USB connector (DEV).
- 3 Select the type of file. Assume you need to copy a trace file:  
Press **Return** > **Copy** > **Type** > **Trace**
- 4 Using the knob or arrow keys to highlight the file name you need. In this example, highlight the file TEST1.TRC.
- 5 Press **Copy Now** to execute the operation. A “Copying file” indicator displays. Then “/USB/TEST1.TRC file copied” appears on the status bar. You have now copied the file TEST1.TRC from the internal storage to the USB storage device.

## Deleting a File

Perform the following process to delete a specific file. Note that once a file is deleted from local memory, it cannot be recovered.

- 1 Press  > **Catalog** > **Local** to select the path
- 2 Press **Return** > **Delete** to access the **Delete** menu
- 3 Select the type of file. Assume you need to delete a trace file  
press **Type** > **Trace**
- 4 Using the knob or arrow keys to highlight the file name you want to load. In this example, selecting the file TEST1.TRC.
- 5 Press **Delete Now**. “Deleting file” indicates the operation is in process. Then, “Local/TEST1.TRC file deleted” shown on the status bar indicates the file has been deleted.

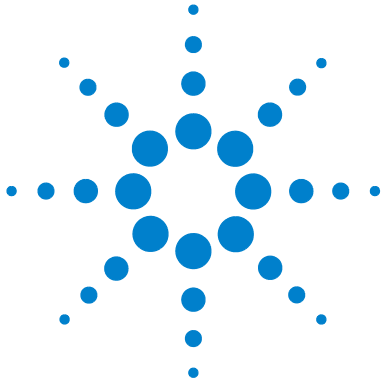

## 4 Key Reference

Amplitude	86
Auto Tune	89
Back <-	90
BW/Avg	91
Det/Display	95
Enter	101
File/Print	102
Frequency	107
Marker	109
Marker->	115
Meas	116
MODE	133
Peak Search	144
Preset/System	148
SPAN	154
Sweep/Trig	156
View/Trace	158

This chapter describes each front panel hardkey and their associated softkeys (menus). The front panel key descriptions are organized alphabetically. The lower level softkeys are listed as they appear in the softkey menus.



## Amplitude

Press **Amplitude** hardkey to activate the reference level function and access the amplitude softkey menu.

The softkey menu selections are described as follows:

**Ref Level** Sets the reference level. This function is activated when **Amplitude** is pressed. The reference level is the amplitude power or voltage represented by the top line of the graticule on the display. Setting the reference level changes the absolute amplitude level (in the selected amplitude units) of the top graticule line.

Key access: **Amplitude**

**Attenuation**  
**Auto Man** Toggles the input attenuation between **Auto** and **Man**. The attenuation level can be set in as little as 1 dB increments when **Man** is selected. The analyzer input attenuator is normally coupled to the reference level control, it reduces the power level of the input signal at the input mixer. Selecting **Auto** re-couples the attenuator. Change the attenuation by using the arrow keys, the knob, or the numeric keypad.

Key access: **Amplitude**

**Scale/Div** Sets the logarithmic units per vertical graticule division on the display. The **Scale/Div** function is available only when the **Scale Type** key is set to **Log**.

Key access: **Amplitude**

**Scale Type**  
**Log Lin** Scales the vertical graticule divisions in logarithmic units when **Log** is selected. The valid logarithmic units are 1, 2, 5 and 10 dB per division. When **Lin** is underlined, the vertical divisions are linearly scaled with default amplitude units of volts. The top of the graticule represents the reference-level value; the bottom of the graticule represents zero volts. (Each division is one-tenth of the reference level.)

Key access: **Amplitude**

**Scale On Off** Toggles the amplitude Scale for each graticule. The vertical divisions are linearly scaled with default amplitude units of volts. The default unit is **dBm**. This softkey is only valid when the **Scale Type** is set to **Lin**.

Key access: 

**Int Preamp On Off** (Option PA3) Toggles the internal pre-amplifier function between on and off. Pressing **Int Preamp (On)** results in a correction being applied to compensate for the gain of the preamp. Amplitude readings then represent the signal value at the input connector. When the preamp is on, a “PA” indication appears on the left side of the display. The preamp operates over a range of 100 kHz to 3 GHz.

Key access: 

**Y Axis** Accesses the softkeys that change the amplitude units (logarithmic or linear). Change the amplitude units by pressing **dBm**, **dBmV**, **dBuV**, **dBuA**, **Watts**, **Volts**, and **Amps**.

Key access:  > **More**

**Ref Lvl Offset** Adds an offset value to the displayed reference level. Reference-level offsets are only entered by using the numeric keypad. Entering an offset does not affect the trace or the attenuation value. Reference-level offsets are used when gain or loss occurs between a device under test and the analyzer input. Thus, the signal level measured by the analyzer may be referred to as the level at the input of an external amplitude-conversion device. When an amplitude offset is entered, its value appears on the left side of the display under **Offst** (as opposed to frequency offsets which appear at the bottom of the display). To eliminate an offset, press **Ref Lvl Offset > 0 > dB**.

Key access:  > **More**

**Att limit** Toggles the attenuation limit function between On and Off.  
**On Off** When this softkey is set to On, the reference level will not exceed the maximum value = (attenuation + 20) dBm.

Key access: **Amplitude** > **More**

**Ext Amp Gain** Adds a positive or negative preamplifier gain value, which is subtracted from the displayed signal. (Use negative values for gain and positive values for loss.) The function is similar to the **Ref Lvl Offset** function, however with the **Ext Amp Gain** function, the attenuation may be changed depending on the preamplifier gain entered. A preamplifier gain offset is used for measurements that require an external preamplifier or long cables. The offset is subtracted from the amplitude readout so that the displayed signal level represents the signal level at the input of the preamplifier. The preamplifier gain offset is displayed at the top of the screen and is removed by entering zero. The preamplifier gain offset can only be entered using the numeric keypad. The preamplifier gain value is not affected by an instrument preset or a power cycle.

Key access: **Amplitude** > **More**



## Auto Tune

Hardkey activates the autotune function to view the signal, This hardkey performs the following functions automatically:

- 1 Run **Peak Search** in full span
- 2 Run **Mkr -> CF**
- 3 Select the appropriate reference level according to the amplitude of searching signal.
- 4 Set span to 1 MHz and all auto couple to view the signal.

### NOTE

The Auto Tune functions in the frequency range of 5 MHz to 3 GHz. The minimum detectable amplitude is -65 dBm.

For more information about **Peak Search**, **Mkr ->CF** and **Mkr ->Ref Lvl** softkeys, refer to “[Peak Search](#)” on page 144, and “[Marker->](#)” on page 115.

## Back <-

The backspace hardkey is located in the numeric keypad area of the front panel and is used to change or correct an active function entry, or to change a text entry before you save data to a file.

## BW/Avg

Hardkey activates the resolution bandwidth function and accesses the softkey menus that control the bandwidth and averaging functions.

### Res BW Auto Man

Softkey controls the 3 dB resolution bandwidth of the analyzer from 10 Hz to 3 MHz using the knob or arrow keys. There are four available bandwidths less than 1 KHz are 10, 30, 100 Hz or 300 Hz. If an invalid bandwidth is entered using the numeric keypad, the analyzer chooses the closest acceptable bandwidth. As the resolution bandwidth is decreased, the sweep time is modified in order to maintain amplitude accuracy. Resolution bandwidth is also coordinated with the frequency span. As the span is decreased, the resolution bandwidth decreases. When the VBW/RBW is set to **AUTO**, if the resolution bandwidth changes, the video bandwidth changes to maintain the VBW/RBW ratio.

A “#” mark appears next to “Res BW” on the display when it is not coupled. To recouple the resolution bandwidth, press **Res BW (Auto)**.

Key access: 

### Video BW Auto Man

Softkey changes the analyzer post-detection filter from 1 Hz to 3 MHz using the knob or arrow keys. If an invalid bandwidth is entered, the analyzer chooses the closest available bandwidth. As the video bandwidth decreases, the sweep time will increase to maintain amplitude accuracy.

A “#” mark appears next to “VBW” on the bottom of the analyzer display when it is not coupled. To couple the video bandwidth, press **Video BW (Auto)**.

Key access: 

**VBW/RBW  
Auto Man**

Sets the ratio between the video and resolution bandwidths. When a signal is weak and is visually masked by the noise floor, set the ratio to less than 1 to lower the noise. When the **Preset Type** is set to **Factory** and **Preset** is pressed, the ratio is set to 1. Change the ratio by using the arrow keys, knob, or numeric keypad. When **VBW/RBW (Auto)** is selected, the ratio is determined automatically by the rules in [Figure 4-1](#).

**Figure 4-1 VBW/RBW Ratio Auto Rules**

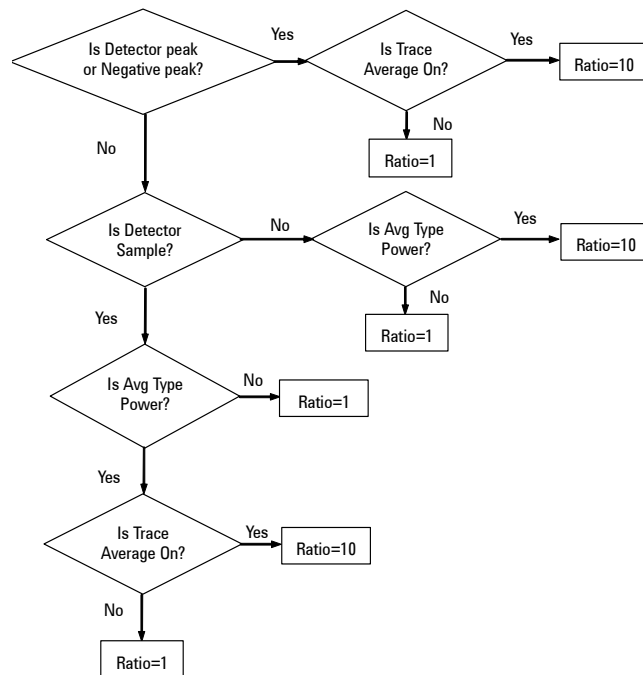

Key access: 

**Average On Off** Initiates a digital averaging routine that averages the trace points in a number of successive sweeps resulting in trace “smoothing”. The number of sweeps (average number) is changeable when setting **Average (Off)**. Increasing the average number will further smooth the trace. pressing  **> Avg Type** to select the type of averaging.

To restart averaging:

- Enter a new average number
- Change any related parameter (e.g., Center Frequency)

When in **sweep single**, the specified number of averages is taken, then the sweep stops and an average trace displayed.

When in continuous sweep mode, the specified number of averages is taken, then the averaging continues with each new sweep averaged in with a weight of  $\frac{1}{\text{AverageNumber}}$  and the old average reduced by multiplying it by

$$\text{AverageNumber} - \frac{1}{\text{AverageNumber}}$$

To turn averaging off, press **Average (Off)**.

Key access: 

**Avg Type Auto Man** Toggles the average type between automatic and manual. Selecting **Auto** sets the analyzer to automatic averaging by the rules in [Figure 4-2](#).

**Figure 4-2 Auto Rules for Average Type**

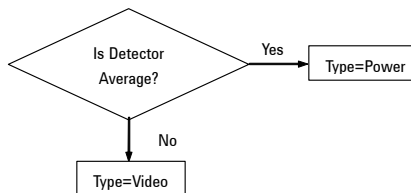

Selecting **Man** sets the analyzer to manual averaging.

When trace average is on, the average type is shown on the left side of the display. Selecting an average type manually causes the analyzer to use that type without regard to other analyzer settings and sets **Avg Type** to **Man**.

Key access: 

**Video Avg** Video averaging averages the data as appropriate for the y-axis scale. When **Avg Type > Video Avg** is selected, “VAvg” appears on the left side of the analyzer display if **Average** is **On**.

Key access:  > **Avg Type**

**Pwr Avg** Power averaging is performed by converting the trace data from logarithmic to linear power units, and then averaging the power trace data. When **Avg Type > Pwr Avg** is selected, “PAvg” appears on the left side of the screen if **Average** is **On**.

Key access:  > **Avg Type**

## Det/Display

**Detector**  
**(detector type)**  
**Auto Man**

Press this hardkey to control detector and display functions.

Softkey presents a submenu to select a specific detector type, or allows the analyzer to select the appropriate detector (select **Auto**) for a particular measurement.

Regarding detectors, it is important to understand what is a trace “bucket”. For every trace point displayed, there is a finite time during which the data for that point is collected. The analyzer looks at all of the data collected during that time and present a single point of trace data based on the detector mode. The interval during which the data for that trace point is being collected, is called the “*bucket*”.

**Figure 4-3 Detector (auto) Selection Flowchart Rules**

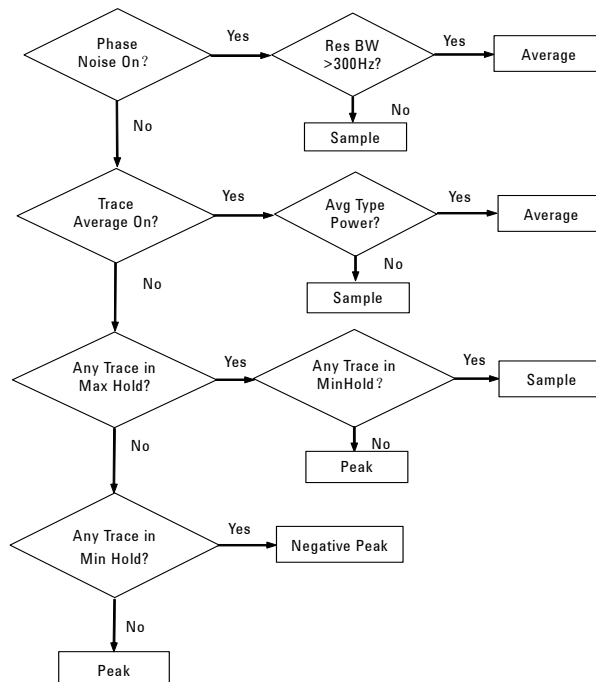

Thus a trace is more than a series of single points. It is actually a series of trace “buckets”. The data may be sampled many times within each bucket.

When the detector is set to **Auto**, Pressing  > **Average (On)** changes the detector. The **Auto** choice will depend on marker functions, trace functions, and the trace averaging function. If a marker function or measurement is running, the **Auto** choice of detector is either **Average** or **Sample**. When one of the detectors (such as **Average**) is manually selected instead of **Auto**, that detector is used without regard to other analyzer settings.

- **Average** displays the power average in the bucket.
- **Sample** displays the instantaneous level of the signal at the center of the bucket represented by each display point.
- **Positive Peak** displays the max. of the signal in the bucket.
- **Negative Peak** displays the min. of the signal in the bucket.

The detector in use is indicated on the left side of the display. A “#” will appear next to it if the detector has been manually selected.

Key access: 

**Auto** Selects peak detection as the default. If a different detection scheme would be better utilized for a particular measurement, the analyzer will use the alternate detection method.

Key access:  > **Detector Auto Man**







**Positive Peak** Obtains the maximum video signal between the last display point and the present display point and stores this value in memory. It's used primarily when measuring sinusoidal components. When **Positive Peak** is selected, “Peak” appears in the upper-left corner.

Key access:  > **Detector Auto Man**

**Negative Peak** Is a peak detector, but selects the minimum video signal value. This detection should not be used to measure the accurate amplitude. “NPK” also appears in the upper-left corner, When **Negative Peak** is selected.

Key access:  > **Detector Auto Man**



<b>Average Video RMS</b>	measures the average value of the amplitude across each trace interval (bucket). When <b>Average</b> is selected, “Avg” appears on the left corner. Key access:  > <b>Detector Auto Man</b>
<b>Sample</b>	Sample detection is used primarily to display noise or noise-like signals. It should not be used to measure the accurate amplitude of non noise-like signals. In sample mode, the instantaneous signal value of the present display point is placed in memory. When <b>Sample</b> detection is selected, “Samp” appears in the upper-left corner of the display. Key access:  > <b>Detector Auto Man</b>
<b>Normal</b>	Selects the maximum and minimum video signal values alternately. When selecting <b>Normal</b> detection, “Norm” appears in the upper-left corner. Key access:  > <b>Detector Auto Man</b>
<b>Active Fctn Position</b>	Selects the screen position for the Active Function Display. Depending on the type of trace data being viewed, you can move the Active Function Display position to minimize its visual interference with your screen data. Key access: 
<b>Top</b>	Displays the active function in the top-left corner of the display. Key access:  > <b>Active Fctn Position</b>
<b>Center</b>	Displays the active function in the center-left side of the display. Key access:  > <b>Active Fctn Position</b>
<b>Bottom</b>	Displays the active function in the bottom-left corner of the display Key access:  > <b>Active Fctn Position</b>

**Display Line On Off** Activates an adjustable horizontal line that is used as a visual reference line. The line, which can be used for trace arithmetic, has amplitude values that correspond to its vertical position when compared to the reference level. The value of the display line appears in the active function block and on the left side of the display. Use the arrow keys, knob, or numeric keypad to adjust the display line. Pressing any digit, 0 through 9, on the numeric keypad brings up the selected terminator submenu.

Key access: 

**Limits** Accesses softkeys that allow you to control and define the parameters of limit lines.

Key access: 

**Limit 1** selects either of the available limits. The **Limit 1** and **Limit 2** keys access softkeys to set parameters for the selected limit.

Key access:  > **Limits**

**Type** defines the limit to be edited as an upper or lower limit. An upper limit will indicate a fail if trace 1 exceeds this limit. A lower limit will indicate a fail if trace 1 falls below the limit.

Key access:  > **Limits** > **Limit 1/2**

**Limit On Off** Toggles the limit line function to on or off. The limit points must exist before the limit function can be turned on. Either **Limit** or **Margin**, as well as **Test**, must be turned on for a limit test. Limit points must be defined before the Limit function can be turned on.

Key access:  > **Limits** > **Limit 1/2**

**Test On Off** Toggles the testing of the limit lines between on and off. If trace 1 is at or within the bounds of the set limit or margin, “Limit\_# Pass” or “Margin\_# Pass” is displayed in the upper left corner of the measurement area limit line. Only positive/negative margins are allowed for lower/upper limits. If the trace is out of the limit or margin boundaries, “Limit\_# Failed” or “Margin\_# Failed” is displayed. Either **Limit** or **Margin** must be turned on for test.

Key access:  > **Limits** > **Limit 1/2**

**Margin On Off** Toggles the margin function to on or off. Use Margin to set a limit line offset for the selected limit line. Either **Limit** or **Margin** as well as **Test**, must be turned on for a limit test to work.

Key access:  > **Limits** > **Limit 1/2**

**Edit** Accesses the submenu to edit the limit point, and also accesses the limits table. Use arrow keys to move between the rows in the limits table. New limit segments will only be applied after close the editor. Pressing **Return**, or any key not associated with the editor, will close the editor.

Key access:  > **Limits** > **Limit 1/2**

### Point

Creates or edit a limit point. Up to 20 points can be defined for each limit line. Enter the point number using the numeric keypad, then Press **[Enter]**, or use the knob or arrow keys to move to an existing point.

Key access:  > **Limits** > **Limit 1/2** > **Edit**

**Frequency**

Edits the frequency value for a limit point. After editing, the limit table will place the frequency or time in correct order. For a new point, the **Amplitude** default is 0 dBm, and **Connected** default is **Yes**.

Key access:  > **Limits** > **Limit 1/2** > **Edit**

**Amplitude**

Sets the amplitude value for the current point.

Key access:  > **Limits** > **Limit 1/2** > **Edit**

**Connected To Previous Pt**

**Yes No**

Defines if the current point being edited is to be connected to the previous point. Pressing this key toggles the **Connected** value between **Yes** and **No**.

Key access:  > **Limits** > **Limit 1/2** > **Edit**

**Delete Point**

Deletes the current point in the limit line. Pressing this key will delete the point immediately.

Key access:  > **Limits** > **Limit 1/2** > **Edit**

**Delete Limit** Deletes the current limit set. Pressing this key will delete the limit line entirely.

Key access:  > **Limits** > **Limit 1/2**

**Delete All Limits** Purges data from the limit-line tables. Pressing this key will delete all the limit line data immediately.

Key access:  > **Limits**

## Enter

Terminates a front-panel keypad numeric entry and enters that value into the analyzer. (For most applications, it is better to use the units softkeys to terminate value entry.) When in **File** menu, the **[Enter]** key is used to terminate filename entries.

## File/Print

Hardkey accesses the softkeys menus to manage the file system of the analyzer. Refer to “[Viewing Catalogs and Saving Files](#)” on page 80, for more information.

**Catalog** Displays all files located on the selected catalog, depending upon the preferences set under the **Type** and **Sort** keys defined below.

Key access:  > **Catalog**

**Type** selects all types or one type of file(s) for viewing.

Default: **State**

Key access:  > **Catalog**

**All** Displays all files and file types on the selected drive.

**Screen** Displays only the screen (.JPG) files on the selected drive.

**State** Displays only the state files (.STA) on the selected drive. State files contain most instrument settings.

**Trace** Displays only trace files (.TRA) on the selected drive.

**Limits** Displays only the limits files (.LIM) on the selected drive.

**Sort** Sorts the files according to a selected file attribute, including **By Date**, **By Name**, and **Order Up Down**. **Order (Up)** sorts files in ascending order (such as A, B, C). **Order (Down)** allows you to sort files in descending order (such as C, B, A).

Key access:  > **Catalog**

**Local** Accesses the internal storage of the analyzer.

Key access:  > **Catalog**

**USB** Accesses the external USB storage device.

Key access:  > **Catalog**

**Save** Accesses menu keys that allow the user to save the analyzer screen, state, trace, and limit data to a USB storage device or to the internal storage.

Key access: 

**Save Now** Executes the save function. When completed, the message “local (USB)/XXX file saved” (where XXX is the filename) will appear in the status bar.

Key access:  > **Save**

**Type** Selects the type of data for the file save.

Key access:  > **Save**

**Screen** Displays all previously saved screen files (.JPG) and captures the current screen displayed in preparation to save it in a file (.JPG).

**State** Displays all saved state (.STA) files and detects the current state parameters in preparation to save into a file (.STA). State files include all settings but not traces or limits.

**Trace** Displays all previously saved trace files (.TRA) and detects the current trace in preparation to save it in a file (.TRA). Save individual traces or a group of traces.

**Limits** Displays all previously saved limits files (.LIM) and detects the current limits in preparation to save them in a file (.LIM). Limits provide data sets to determine whether a trace has exceeded preset specifications.

**Source** When **Type** is **Trace**, you can select trace **1**, **2**, **3** or **4** in addition to the state. **All Traces** is selected to save all four traces in a single file, along with the state.

When **Type** is **Limits**, **Source** accesses the **Limit 1** and **2** softkeys. **Limit 1** and **2** provide data sets to determine whether a measurement trace has exceeded preset specifications.

Key access:  > **Save**

**Name** Accesses the softkeys to enter the filename.

Key access:  > **Save**

**NOTE**

Only capital letters and digits may appear in file names. The analyzer will automatically add the three character file extension name.

**Load** Accesses a submenu to load analyzer states, traces and limits into the analyzer from a USB storage device or internal storage (**Local**).

Key access: 

**Load Now** Executes the load file function. When load completed, the message “local(USB)/XXX file loaded” appears in the status bar (where XXX is the filename).

Key access:  > **Load**





**Type** To select the type of file to be loaded.





Key access:  > **Load**

**State** Displays all state file types listed in the storage location (.STA). Loading a state file type restores most parameters to the instrument settings.

**Trace** Displays all trace file types (.TRA). Load traces individually or as a group. Loading a trace also loads the current state, and sets the trace to view mode.



- Limits** Displays all limits file types. The limits data points in these files may help determine whether a trace has exceeded preset specifications (.LIM). Limits are loaded individually only.
- Sort** Accesses a submenu to view your saved files according to a selected file attribute. The selections include, **By Date**, **By Name**, and **Order Up Down**. **Order (Up)** sorts files in ascending order (such as A,B,C). **Order (Down)** sorts files in descending order (such as C,B,A).  
Key access:  > **Load**
- Destination** With **Type** set to **Trace**, **Destination** directs the data to **Trace 1, 2, 3** or **4**. If the data is for all four traces (for instance, **Source** was **All Traces** when they were saved), the data returns to the original trace registers.  
When **Type** is set to **Limits**, **Destination** allows you to direct your data to **Limit 1** or **Limit 2**.  
Key access:  > **Load**
- Delete** Enter the submenu for deletion.  
Key access: 
- Delete Now** Executes the delete file function. After a successful delete, the message “local(USB)/XXX file deleted” appears in the status bar on the display (where XXX is the filename).  
Key access:  > **Delete**
- Type** Selects the filetype to delete.  
Key access:  > **Delete**
- All** Displays all files for deletion.
- Screen** Displays only screen files for deletion.
- State** Displays only state files for deletion.

	<b>Trace</b>	Displays only trace files for deletion.
	<b>Limits</b>	Displays only limits files for deletion.
<b>Sort</b>		Sorts the files according to a file attribute for deletion: <b>By Date</b> , <b>By Name</b> and <b>Order Up Down</b> . <b>Order (Up)</b> displays files in ascending order. <b>Order (Down)</b> displays files in descending order. Key access:  > <b>Delete</b>
<b>Copy</b>		Enters the submenu to copy files from local to a USB storage device. Key access: 
<b>Copy Now</b>		Executes the copy function. If the copy is successful, “local/XXX file copied to USB” will appear in the status bar (where XXX is the filename). Key access:  > <b>Copy</b>
<b>Type</b>		Select the type of file to copy. Key access:  > <b>Copy</b>
	<b>All</b>	Displays all file types.
	<b>Screen</b>	Displays all screen files.
	<b>State</b>	Displays all state files.
	<b>Trace</b>	Displays all trace files.
	<b>Limits</b>	Displays all limits files.
<b>Sort</b>		Sorts the files according to a file attribute to be copied, including <b>By Date</b> , <b>By Name</b> and <b>Order Up Down</b> . <b>Order (Up)</b> displays files in ascending order. <b>Order (Down)</b> displays files in descending order. Key access:  > <b>Copy</b>

# Frequency

Press **Frequency** to activate the center frequency function, and access the menu softkeys for frequency functions. The center frequency, or start and stop frequency values appear below the graticule on the display.

## NOTE

When changing both the center frequency and span, change the frequency first. The frequency value may limit the span.



- |                             |  |
|-----------------------------|--|
| <b>Center Freq</b>          | Softkey activates the center frequency function and sets the horizontal center of the display to a specific frequency.<br>Key access: <b>Frequency</b>   |
| <b>Start Freq</b>           | Softkey sets the frequency starting at the left side of the graticule. The left and right sides of the graticule correspond to the start and stop frequencies.<br>Key access: <b>Frequency</b>   |
| <b>Stop Freq</b>            | Softkey sets the frequency at the right side of the graticule. The left and right sides of the graticule correspond to the start and stop frequencies.<br>Key access: <b>Frequency</b>   |
| <b>CF Step<br/>Auto Man</b> | Softkey changes the step size for the center frequency function. On selecting a step size and activating the center frequency function, the arrow keys change center the frequency by the step-size value. The step size function is useful for finding harmonics and sidebands beyond the current frequency span of the analyzer. Selecting auto-couple sets the center frequency step size to one division (10 percent of the span).<br>Key access: <b>Frequency</b> |

**Freq Offset** Allows you to input a frequency offset value that is added to the frequency readout of the marker, to account for frequency conversions external to the analyzer. Offset entries are added to all frequency readouts including marker, start frequency, and stop frequency. Offsets may only be entered using the numeric keypad. Offsets are not added to the span or frequency count readouts. Entering an offset does not affect the trace display. When a frequency offset is entered, its value appears on the bottom of the display. To eliminate an offset, perform a **Factory Preset**, or press **Freq Offset, 0, Hz**.

When a frequency offset is entered, its value appears on the bottom of the display (as opposed to reference level offsets, which appear on the left side of the display). To eliminate an offset, press **Freq Offset, 0**, and **Enter**. Pressing **Preset** also sets the offset to zero.

Key access: 

**Signal Track On Off** Softkey moves the signal nearest the active marker to the center of the display and maintains the signal at the center of the display. “ST” will appear in the lower-left corner of the display.

Pressing **Signal Track (Off)**;  > **Preset** (**Preset Type** set to **Factory**); or  > **All Off** will turn off the signal track function.

Toggling signal track to on and reducing the span initiates an automatic zoom and will reduce the span in steps, so that the signal remains at the center of the display. Signal track cannot be activated, if the span is set to zero.

Key access: 

#### NOTE

If no marker is active, pressing **Signal Track (On)** activates a marker, perform a peak search, and center the marker on the display. Switching to zero span turns **Signal Track (Off)**.

# Marker

Hardkey accesses the marker control softkey menus to select the type and number of markers. Markers are shown on the display as diamond-shaped characters that identify points of traces. Up to twelve pairs of markers (when using Delta Pair markers) may appear on the display simultaneously; only one pair can be controlled at a time.

**Select Marker** Selects one of the twelve possible markers. If a marker has already been selected it will become the active marker.

Key access: 

**Normal** Activates a single frequency marker at the center of the active trace if not already displayed.

Displaying a marker before enabling the **Normal** function enables the marker at the position of the selected marker. The marker number shows above the marker. The knob and/or arrow keys move the marker left or right. Entering a value from the numeric keypad moves the marker to the trace point nearest to that value. Annotation in the active function block and in the upper-right corner indicates the frequency and amplitude of the marker (time and amplitude, if in zero span.) Pressing **Normal** turns off the **Delta** function and moves the active marker to the delta marker position.

Key access: 

**Delta** Accesses the submenu to use the marker delta function.

Key access: 

**Delta On Off** **Delta (On)** activates a second marker at the position of the first marker. If no marker is present, two markers with the same identification number will appear at the center of the display. The marker number is indicated above the delta marker, and the same number is indicated with an R (for example, 1R) above the reference marker. The amplitude and frequency (or time) of the first marker is fixed.

Use the data control keys to position the delta marker. Annotation in the active function block and in the upper-right corner indicates the differences between the two markers, frequency/time and amplitude. **Delta (Off)** moves the reference marker to the active marker position, allowing you to make delta measurement from differing reference points without having to turn off the markers and begin again.

Key access:  > **Delta**

**Delta Pair**  
**Ref Delta** Toggles the **Delta Pair** between the reference (start) and delta (stop) markers. The start marker number is indicated with a number and an R (reference) above the marker (for example, 1R). The delta marker is identified with the marker number only.

Key access:  > **Delta**

**Span Pair**  
**Span Center** Toggles the **Span Pair** function between the span and center markers. The start marker number is indicated with a number and an R above the marker (such as 1R) and the stop marker is indicated with only the marker number. Adjusting the span changes the frequency difference between the two markers while maintaining the midpoint at a fixed frequency. Selecting **Center** changes the center point between the two markers while maintaining the frequency difference.

Key access:  > **Delta**

#### NOTE

Ref and Delta markers maintain their displayed x-axis location, however, their frequency values will change if the frequency or span parameters that define the x-axis scale are changed. Reset these markers, if necessary, when parameters such as Span or Center Freq are changed.

**Off** Turns off the selected marker by the **Select Marker** key. **Off** also turns off the related functions such as signal track. It will also removes marker annotation from the display.

Key access: 

- All Off** Turns off all markers, including markers used for signal track, and marker annotations.  
Key access: **Marker**
- Function** Accesses the marker function softkeys listed below.  
Key access: **Marker**
- Freq Counter** Accesses the frequency counter function.  
Key access: **Marker** > **Function**
- Freq Counter On Off** Toggles the frequency counter function on and off.
- Resolution Auto Man** Toggles the frequency counter resolution from manual to auto-couple. The allowed values are 0.1, 1, 10, 100 Hz and 1 kHz. Pressing **Auto** auto-couples frequency counter resolution to the span.

**NOTE**

The ratio of the resolution bandwidth to span must be greater than 0.02 for proper frequency counter function. The frequency counter will work correctly only on CW signals or discrete peaks. For an accurate reading, the marker must be >40 dB above the noise.

- Phase Noise** Accesses the phase noise function softkeys.  
Key access: **Marker** > **Function**
- Phase Noise On Off** Toggles the phase noise function on and off.
- Offset Manual** Manually sets the offset of the marker to measure phase noise.
- Offset** Sets the offset to  $\pm 1$ ,  $\pm 10$ ,  $\pm 20$ ,  $\pm 30$ ,  $\pm 50$ ,  $\pm 100$  kHz or  $\pm 1$  MHz.

**Optimize  
Phase Noise**

This softkey is valid only when span fall in the range of 100 Hz and 100 kHz. After enabling this softkey, the 1st LO Loop filter bandwidth will be changed from approx. 5 kHz to 120-150 kHz automatically, which optimizes the phase noise close in to the carrier. For more details on how to measure the phase noise of a signal, refer to “[Measuring Phase Noise](#)” on page 56.

Key access:  > **Function**

**NOTE**

**Optimize Phase noise (On)** will worsen phase noise accuracy far away from the carrier. When testing phase noise far away from the carrier, select **Optimize Phase noise (Off)**.

---

**Marker Noise** Toggles the Marker Noise function between On and Off. When Marker Noise is set to On, the display Reads out the average noise level, referenced to a 1 Hz noise power bandwidth. If no marker is present, a marker appears at the center of the display. When Marker Noise is enabled in resolution bandwidths of 1 kHz and above, the auto coupled detector selection is set to Average and the Avg Type is set to Power because the trade-off between sweep time and variance of the result is best with power Average detection. However, the Marker Noise function generates appropriately corrected values for all supported detector modes. If the marker delta function is on and the noise marker is activated and moved to measure the noise floor, the marker readout will display the signal-to-noise ratio.

**NOTE**

You can use **Delta** and **Marker Noise** to indicate noise level relative to sinusoidal signal (signal to noise). Activate the delta marker before pressing **Marker Noise** or the reference marker units may be incorrect.

---



The noise marker averages 5% of the trace data values (one-half a horizontal division), centered on the location of the marker on the frequency or time scale. Marker noise indicates noise power density per Hertz or noise voltage per root Hertz depending upon the amplitude units selected. The number of sweep points is noted in parenthesis to the right of the sweep time in the lower right corner of the graticule.

Note that the data values averaged will not always be symmetrical with respect to the marker position. If the marker is positioned within 2.5% of the beginning of the trace (one-quarter division), the trace data values in the first half-division will be averaged. Similarly, if the marker is positioned within 2.5% of the end of the trace, the trace data values in the last half-division will be averaged.

**NOTE**

Do not use Marker Noise to evaluate the displayed average noise level of the analyzer relative to the specification. Read the displayed average noise level directly from the display or use the normal marker. Refer to Application Note 150 for a discussion of how noise is displayed on a spectrum analyzer.

---

To guarantee accurate data for noise-like signals, a correction for equivalent noise bandwidth for each resolution bandwidth is measured and included in the measurement. The Marker Noise function accuracy is optimal when the detector is set either to Average or to Sample because neither of these detectors peak-biases the noise.

Key access: **Marker** > **Function**

**Marker Trace** Places a marker on the selected trace, if no markers have been previously turned on. If a marker is currently active, press **Marker Trace** until **1**, **2**, **3**, or **4** is underlined: the active marker moves to the selected trace.

**Auto 1 2 3 4**

Selecting **Auto** mode moves the marker to the automatically selected trace. The trace selection will search for the lowest numbered trace in the following mode order: **Clear-write**, **Max-hold**, **Min-hold** and **View**. If there are no traces in any of these modes, it selects trace **1**.

Key access:  > **More**

**Marker Table** Compresses the graticule and displays marker information in a table. The information includes the marker number, trace number, marker type, X axis value, and the amplitude.

Key access:  > **More**

**On** Activates/deactivates the marker table.

**Off** Key access:  > **More** > **Marker Table**

**Prev Page** displays the previous/next page of the marker table.

**Next Page** Key access:  > **More** > **Marker Table**

## Marker->

Press  accesses the following marker function softkeys:

**Mkr → CF** Sets the frequency of the marker to the center frequency. In delta mode, **Mkr → CF** sets the displayed trace center frequency to the frequency of the marker delta value. **Mkr → CF** is not available in zero span.

Key access: 

**Mkr → CF Step** Changes the center-frequency step size to match the value of the active marker. Press  > **CF Step** to view the step size. The step size is the frequency difference between the markers when marker delta is active. Use this function to step from one signal harmonic to another. **Mkr → CF Step** is not available in zero span.

Key access: 

**Mkr → Start** Changes the display start frequency to the frequency of the active marker. In delta mode, **Mkr → Start** sets the start frequency to the marker delta value. **Mkr → Start** is not available in zero span.

Key access: 

**Mkr → Stop** Changes the stop frequency to the frequency of the active marker. In Delta mode, **Mkr → Stop** sets the stop frequency to the marker delta value. **Mkr → Stop** is not available in zero span.

Key access: 

**Mkr → Ref Lvl** Changes the reference level to the active marker value, moving the marked point to the reference level (top line of the graticule). In delta mode, **Mkr → Ref Lvl** sets the reference level to the amplitude difference between the markers. (For example, if the difference is -15 dB, the reference level -15 dBm.)

Key access: 

## Meas

In the **Spectrum Analyzer** mode (see **MODE**), **Meas** key displays a menu for measurements such as adjacent channel power, occupied bandwidth, channel power, spectrum emission mask and TOI. Press **Measure Off** to turn the measurement off.

### Channel Power

Channel Power measures the power and power spectral density in the specified channel bandwidth. A white frame on the display indicates the edge limits of the channel bandwidth. The user must specify the center frequency, reference level, and channel bandwidth to be used for the measurement.

The power calculation method used to determine the channel power is a traditional method known as the integration bandwidth (IBW) method. A swept spectrum is used as the basis for this calculation. Therefore, it is important to set the resolution bandwidth correctly before making this measurement using the following formula:

$$RBW = \frac{k(\text{span})}{n}$$

**Figure 4-4 Channel Power Measurement**

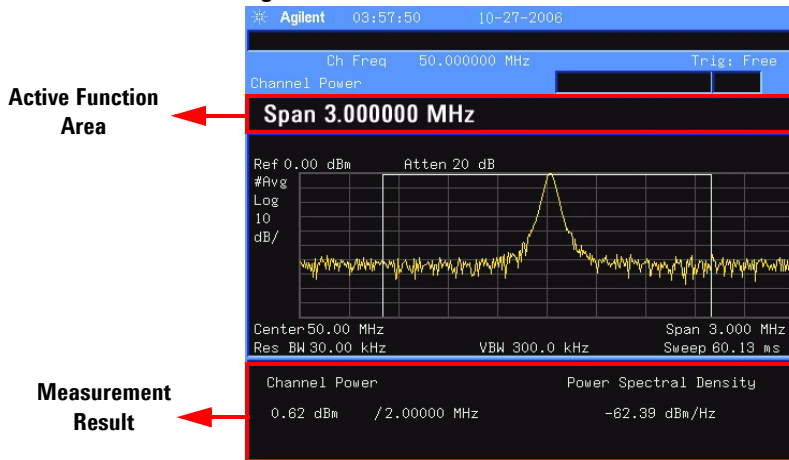

- Avg Number On Off** Specifies the number of measurement averages used when calculating the measurement result with **Avg Number (On)**. The range is 1 to 1000. Use the knob, the arrow keys or the numeric keypad to set the number. The average will be displayed at the end of each sweep. Selecting **Off** disables measurement averaging.  
Key access: **Meas** > **Channel Power**
- Avg Mode Exp Repeat** Toggles the average mode between **Exp** or **Repeat**. This determines the averaging action after the specified number of measurements (average count) is reached.  
When selecting **Exp**, each successive data acquisition after the average count is reached is exponentially weighted and combined with the existing average. Exponential averaging weights new data more than old data, which facilitates tracking of slow-changing signals. The average will be displayed at the end of each sweep.  
When selecting **Repeat**, after reaching the average count, all previous data is cleared and the average count is back to 1.  
Key access: **Meas** > **Channel Power**
- Integ BW** Specifies the range of integration used in calculating the power in a channel. For example, set the main (center) channel bandwidth. Note that the white frame indicates the integration bandwidth. Be sure the span is set between 1 and 10 times the integration bandwidth. Change integration bandwidth by using the knob and the arrow keys.  
Key access: **Meas** > **Channel Power**
- Chan Pwr Span** Specifies the frequency span used for the channel power measurement by using the knob and the arrow keys. Be sure the span is set between 1 and 10 times the integration bandwidth.  
Key access: **Meas** > **Channel Power**

## Occupied BW

Occupied Bandwidth integrates the power of the displayed spectrum. The power-bandwidth routine first computes all signal power contained in the trace, then calculates the span containing the power of the specified percentage. The percentage value default is 99% of the occupied bandwidth power.

For 99% occupied power bandwidth, Markers are placed at the frequencies on either side of 99% of the power. 1% of the power is evenly distributed outside the markers. The difference between the marker frequencies is the 99% power bandwidth.

This is the main menu of occupied bandwidth measurement including all related parameters and measurement results.

**Figure 4-5 Occupied Bandwidth Measurement**

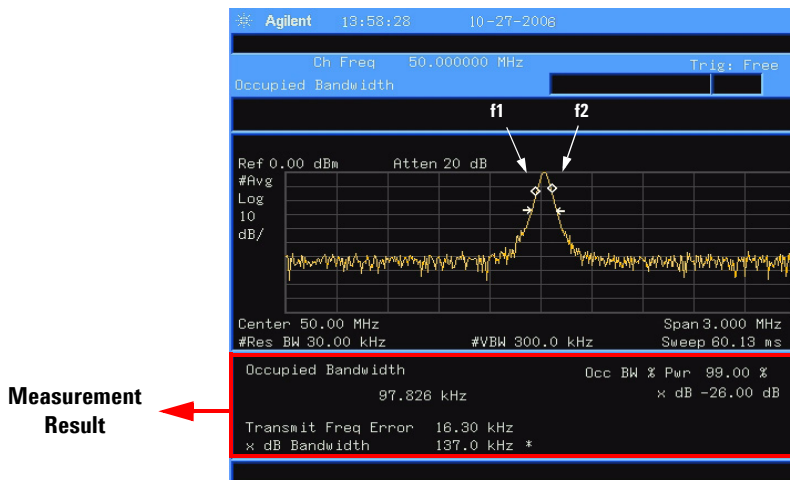

The occupied bandwidth function also indicates the difference between the center frequency and the center frequency of the channel. This “Transmit Freq Error” is defined

as the difference between the  $(f_1 + f_2)/2$  and the tuned center frequency of the signal.

**NOTE**

To get the correct measurement result, first set the center frequency, reference level, and channel spacing.

- |                                      |  |
|--------------------------------------|--|
| <b>Avg Number</b><br><b>On Off</b>   | Select <b>On</b> to specify the number of measurement averages used when calculating the measurement result. The average is displayed at the end of each sweep. Select <b>Off</b> to disable measurement averaging. The range is from 1 to 1000.<br>Key access: <b>Meas</b> > <b>Occupied BW</b>   |
| <b>Avg Mode</b><br><b>Exp Repeat</b> | Toggles the termination control type used for the averaging function between <b>Exp</b> and <b>Repeat</b> . This determines the averaging action after the specified number of measurements (average count) is reached.<br><br>When you select <b>Exp</b> , each successive data acquisition after the average count is reached is exponentially weighted and combined with the existing average. Exponential averaging weights new data more than old data, which facilitates tracking of slow-changing signals. The average is displayed at the end of each sweep.<br><br>When you select <b>Repeat</b> , after reaching the average count, all previous data is cleared and the average count is reset to 1 and the averaging process is restarted.<br>Key access: <b>Meas</b> > <b>Occupied BW</b> |
| <b>Max Hold</b><br><b>On Off</b>     | Toggles the maximum hold trace feature between <b>On</b> and <b>Off</b> . Maximum hold displays and holds the maximum responses of a signal.<br>Key access: <b>Meas</b> > <b>Occupied BW</b>   |
| <b>Occ BW% Pwr</b>                   | Edits the percentage of signal power used when determining the occupied bandwidth.<br>Key access: <b>Meas</b> > <b>Occupied BW</b>   |

**OBW Span** Specifies the integration range used to calculate the total power from which the percent occupied bandwidth is then calculated. The analyzer span will be set to the same value as the OBW Span for the measurement. OBW Span should be set to an approximate multiple of 2 times the expected occupied bandwidth result. The range is from 100 Hz to 3 GHz.

Key access: **Meas** > **Occupied BW**

**x dB** Specifies the power level used to determine the emission bandwidth as the number of dB down from the highest signal point, within the occupied bandwidth span. This function is an independent calculation from the OBW calculation. The x dB Bandwidth result is also called the emissions bandwidth, or EBW. Two arrows will be set to the specified dB value below the maximum power level and the total power between the arrows will be computed. Frequencies f1 and f2 are determined as the furthest frequencies x dB below and above maximum power level, respectively. The emission bandwidth is then calculated as  $f2 - f1$  as shown by the arrows indicated in [Figure 4-5](#) (note that the diamond markers are for the OBW function). The range is from -100.0 to -0.1 dB.

Key access: **Meas** > **Occupied BW**

#### NOTE

The asterisk next to the x dB bandwidth value in [Figure 4-5](#) indicates the results may not have been determined with optimal analyzer settings. If emission bandwidth is your primary interest, select **Max Hold**. Then change detector mode to peak by pressing **Det/Display** > **Detector** > **Positive Peak**. Acquiring peak data ensures accuracy of this measurement.



## ACP

Adjacent Channel Power (ACP) measures the power present in adjacent transmit channels. The span is automatically set according to the six available offsets and their associated integration bandwidths as defined by the user.

**Figure 4-6 Adjacent Channel Power Measurement**

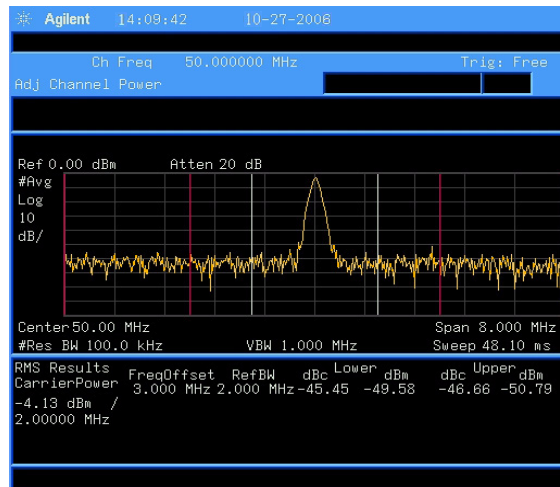

**Avg Number On Off** Pressing **On** specifies the number of measurements that will be averaged when calculating the measurement result. The average will be displayed at the end of each sweep. Pressing **Off** disables the measurement averaging.

Key access: **Meas** > **ACP**

**Avg Mode Exp Repeat** Enables the user to select the type of termination control used for the averaging function (**Exp** or **Repeat**). This determines the averaging action after the specified number of measurements (average count) is reached.

When selecting **Exp**, each successive data acquisition after the average count is reached is exponentially weighted and combined with the existing average. Exponential averaging weights new data more than old data, which facilitates tracking of slow-changing signals. The average is displayed at the end of each sweep.

When selecting **Repeat**, after reaching the average count, all previous data is cleared and the average count is back to 1.

Key access: **Meas** > **ACP**

**Chan Integ BW** Specifies the range of integration used in calculating the power in the main channel. Use the knob and the arrow keys to set the bandwidth.

Key access: **Meas** > **ACP**

**Offset/Limits** Accesses softkeys that allow you to configure the offsets for the ACP measurement.

Key access: **Meas** > **ACP**

**Offset** Selects the offset the softkeys will affect. Press **A B C D E F** Offset until the letter of the desired offset is underlined.

Key access: **Meas** > **ACP** > **Offset/Limits**

**Offset Freq** Sets the frequency difference from the center of the main channel to the center of the offset for a maximum of 6 offsets (labeled A-F). It also allows you to turn **On/Off** the offsets that you want to measure.

Key access: **Meas** > **ACP** > **Offset/Limits**

**Ref BW** Sets the reference bandwidth (integration bandwidth) for each offset.

Key access: **Meas** > **ACP** > **Offset/Limits**

**Pos Offset Limit** Sets the upper limit for the upper segment of the specified offset pair.

Key access: **Meas** > **ACP** > **Offset/Limits**

**Neg Offset Limit** Sets the upper limit for the lower segment of the specified offset pair.

Key access: **Meas** > **ACP** > **Offset/Limits**

- Meas Type** Specifies the reference for the measurement, either **Total Pwr Ref** or **PSD Ref**. Relative values are displayed referenced to either the total power (**Total Pwr Ref**) or the power spectral density (**PSD Ref**) measured in the main channel.  
Key access: **Meas** > **ACP**
- Method  
IBW RBW** Enables you to select the measurement method. The resolution bandwidth (**RBW**) method is most useful for measuring cdmaOne signals; the integration bandwidth method (**IBW**) is preferred for other signals.  
Key access: **Meas** > **ACP** > **More**
- Total Pwr Ref  
(PSD Ref)  
Auto Man** Sets the adjacent channel power reference to automatic or manual when **Meas Type** is set to **Total Pwr Ref**. When select **Auto**, the carrier power result reflects the measured power value in the carrier. When set to **Man**, the last measured value is captured and held, or may be entered by the user. Relative values are displayed, referenced to the total power measured in the main channel.  
When **Meas Type** is set to **PSD Ref**, pressing this key sets the power spectral density in the carrier (main channel) that is used to compute the relative power spectral density values for the offsets. When the PSD Ref state is set to **Auto**, this will be set to the measured carrier power spectral density.  
Key access: **Meas** > **ACP** > **More**
- Limits  
On Off** Turns limits testing on or off. When select **On**, each offset is compared to its upper and lower offset limit. In those cases where the power exceeds the limit, the calculated result will be displayed in red to indicate a failure. If there are any failures, the pass/fail indicator area show "FAIL" in red; if there are none, it shows "PASS" in green when using IBW method. Neither "FAIL" nor "PASS" will be displayed when using RBW method. Any offsets that are in the off state are not measured and no results will be displayed.  
Key access: **Meas** > **ACP** > **More**

## Intermod (TOI)

The third order intermodulation (TOI) measurement computes and displays the output intercept point (IP3), and places arrows upon the trace to indicate the measured signals and third-order products.

**Figure 4-7 TOI Measurement**

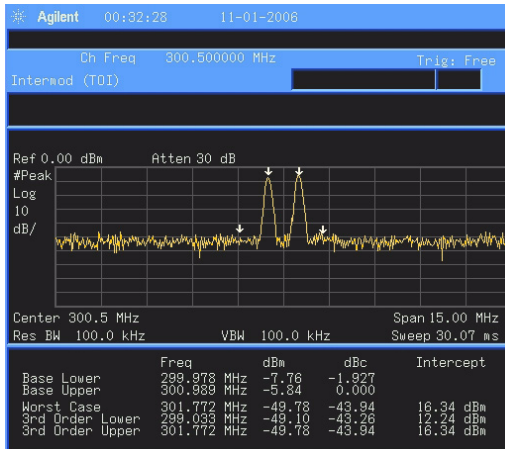

### Avg Number On Off

Set **Avg Number** to **On** to specify the number of measurement averages used when calculating the measurement result. The average will be displayed at the end of each sweep. Setting **Avg Number** to **Off** disables measurement averaging.

Key access: **Meas** > **More** > **Intermod (TOI)**

### Avg Mode Exp Repeat

Selects the type of termination control used for the averaging function (**Exp/Repeat**). This determines the averaging action after the specified number of measurements (average count) is reached.

When **Avg Mode** is **Exp**, Each successive data acquisition after the average count is reached is exponentially weighted and combined with the existing average. Exponential averaging weights new data more than old data, which facilitates tracking of slow-changing signals. The average is displayed at the end of each sweep.

When **Avg Mode** is **Repeat**, after reaching the average count, all previous data is cleared and the average count is back to 1.

Key access: **Meas** > **More**> **Intermod (TOI)**

**TOI Span** Specifies the frequency span in which intermodulation products are measured. If you modify the value of span in the base instrument **Span** menu, the value in the **Intermod (TOI)** menu will be updated to reflect the new value, and the measurement will restart if it is running.

Key access: **Meas** > **More**> **Intermod (TOI)**

**Max Mixer Lvl**  
**Auto Man** Sets the relationship between the highest signal that can be displayed (the reference level) and the input attenuation. The relationship applies whenever the **Attenuation** is set to **Auto**. The relationship is that the attenuation is given by reference level minus the max mixer level. For example, as the reference level changes, the input attenuator changes to ensure that a signal at the reference level does not exceed the **Max Mixer Lvl** setting.

When the TOI measurement is off, the previous maximum **Max Mixer Lvl** is restored.

Pressing **Auto** sets the maximum mixer level to -30 dBm.

Key access: **Meas** > **More**> **Intermod (TOI)**

## Spectrum Emission Mask

Spectrum Emission Mask measurement includes the in-band and out-of-band spurious emissions. As it applies to W-CDMA (3GPP), this is the power contained in a specified frequency bandwidth at certain offsets relative to the total carrier power. It may also be expressed as a ratio of power spectral densities between the carrier and the specified offset frequency band. For WLAN, the reference power is taken as the peak PSD in the signal, and all offset results are also the peak PSD in that offset as opposed to the integrated power.

**Figure 4-8 Spectrum Emission Mask**

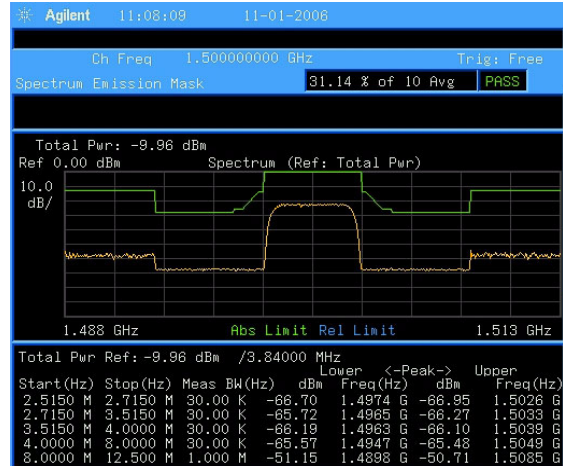

**Avg Number On Off** Set **Avg Number** to **On** to specify the number of measurement averages used when calculating the measurement result. The average will be displayed at the end of each sweep. Setting **Avg Number** to **Off** disables measurement averaging.

Key access: **Meas** > **More** > **Spectrum Emission Mask**

**Meas Type** Displays a menu to select a measurement reference type, **Total Pwr Ref** or **PSD Ref**.

Key access: **Meas** > **More** > **Spectrum Emission Mask**

<b>Total Pwr Ref</b>	<p>When <b>Total Pwr Ref</b> is selected, the power in the carrier is used as the reference in computing the relative power values for the offsets.</p> <p>Key access: <b>Meas</b> &gt; <b>More</b> &gt; <b>Spectrum Emission Mask</b> &gt; <b>Meas Type</b></p>
<b>PSD Ref</b>	<p>When <b>PSD Ref</b> is selected, the mean power spectral density of the carrier is used in computing the relative power spectral density values for the offsets.</p> <p>Key access: <b>Meas</b> &gt; <b>More</b> &gt; <b>Spectrum Emission Mask</b> &gt; <b>Meas Type</b></p>
<b>Ref Channel</b>	<p>Accesses the softkeys to change the reference channel settings.</p> <p>Key access: <b>Meas</b> &gt; <b>More</b> &gt; <b>Spectrum Emission Mask</b></p>
<b>Chan Integ BW</b>	<p>Specifies the integration bandwidth used in calculating the power in the main channel.</p> <p>Key access: <b>Meas</b> &gt; <b>More</b> &gt; <b>Spectrum Emission Mask</b> &gt; <b>Ref Channel</b></p>
<b>Chan Span</b>	<p>Specifies the span used in measuring the power in the main channel.</p> <p>Key access: <b>Meas</b> &gt; <b>More</b> &gt; <b>Spectrum Emission Mask</b> &gt; <b>Ref Channel</b></p>
<b>Sweep Time Auto Man</b>	<p>Specifies the sweep time used in measuring the power in the main channel.</p> <p>Key access: <b>Meas</b> &gt; <b>More</b> &gt; <b>Spectrum Emission Mask</b> &gt; <b>Ref Channel</b></p>
<b>Res BW Auto Man</b>	<p>Specifies the resolution bandwidth used in measuring and the power in the main channel.</p> <p>Key access: <b>Meas</b> &gt; <b>More</b> &gt; <b>Spectrum Emission Mask</b> &gt; <b>Ref Channel</b></p>

**Total Pwr Ref (PSD Ref)**

Displays the type of power measurement reference selected by **Meas Type**.

**Auto Man**

**Total Pwr Ref** is the power in the carrier that is used as the reference in computing the relative power values for the offsets. When **Man** is selected, this can be set by the user. When **Auto** is selected, this is the measured power in the reference carrier.

**PSD Ref** is the mean power spectral density in the carrier that is used as the reference in computing the relative power spectral density values for the offsets. When **Man** is selected, this can be set by the user. When **Auto** is selected, this is the measured mean power spectral density in the reference carrier.

Key access: **Meas** > **More** > **Spectrum Emission Mask** > **Ref Channel**

**Offset/Limits**

Displays the menus to change the following parameters for offset frequency settings and pass/fail tests: **Offset**, **Start Freq**, **Stop Freq**, **Sweep Time**, **Res BW**, and **Limits**. Refer to the tables below for default settings of particular radio standards of interest.

Key access: **Meas** > **More** > **Spectrum Emission Mask**

**Table 4-1 Offsets & Limits Defaulted for W-CDMA (3GPP) Base Station Measurements<sup>a</sup>**

Offset	Start Freq (MHz)	Stop Freq (MHz)	Res BW (kHz)	Abs Start (dBm)	Abs Stop (dBm)	Abs Couple	Rel Start (dBc)	Rel Stop (dBc)	Meas BW
A. On	2.515	2.715	30.00	-14.00	-14.00	Couple	-30.00	-30.00	1
B. On	2.715	3.515	30.00	-14.00	-26.00	Man	-30.00	-30.00	1
C. On	3.515	4.000	30.00	-26.00	-26.00	Couple	-30.00	-30.00	1
D. On	4.000	8.000	1000.00 30.00	-13.00	-13.00	Couple	-30.00	-30.00	1 33
E. On	8.000	12.500	1000.00	-13.00	-13.00	Couple	-30.00	-30.00	1

a. **Fail Mask** is set to **Absolute** and **Rel Stop** is set to **Couple**.



**Table 4-2 Offsets & Limits Defaulted for W-CDMA (3GPP) Mobile Station Measurements<sup>a</sup>**

Offset	Start Freq (MHz)	Stop Freq (MHz)	Res BW (kHz)	Abs Start (dBm)	Abs Stop (dBm)	Rel Couple	Rel Start (dBc)	Rel Stop (dBc)	Meas BW
A. On	2.515	3.485	30.00	-71.07	-71.07	Man	-35.23	-49.78	1
B. On	4.000	7.500	1000.0	-55.84	-55.84	Man	-35.50	-39.00	1
C. On	7.500	8.500	1000.00	-55.84	-55.84	Man	-39.00	-49.00	1
D. On	8.500	12.000	1000.00	-55.84	-55.84	Couple	-49.00	-49.00	1
E. Off	12.500	15.000	1000.00	-55.84	-55.84	Couple	-49.00	-49.00	1

a. **Abs Stop** is set to **Couple** and **Fail Mask** is set to **Abs AND Rel**.

**Table 4-3 Offsets & Limits Defaulted for 802.11a and HiperLAN/2 Radio Standards<sup>a</sup>**

Offset	Start Freq (MHz)	Stop Freq (MHz)	Abs Start (dBm)	Abs Stop (dBm)	Abs Couple	Rel Start (dBc)	Rel Stop (dBc)	Rel Couple	Meas BW
A. On	9.00	11.00	16.00	-4.00	Man	0.00	-20.00	Man	1
B. On	11.00	20.00	-4.00	-12.00	Man	-20.00	-28.00	Man	1
C. On	20.00	30.00	-12.00	-24.00	Man	-28.00	-40.00	Man	1
D. On	30.00	50.00	-24.00	-24.00	Couple	-40.00	-40.00	Couple	1
E. Off	50.00	100.00	-24.00	-24.00	Couple	-40.00	-40.00	Couple	1

a. **Res BW** is set to 100 kHz and **Fail Mask** is set to **Rel**.

Table 4-4 Offsets & Limits Defaulted for 802.11b Radio Standard<sup>a</sup>

Offset	Start Freq (MHz)	Stop Freq (MHz)	Abs Start (dBm)	Abs Stop (dBm)	Rel Start (dBc)	Rel Stop (dBc)	Meas BW
A. On	11.00	22.00	-10.00	-10.00	-30.00	-30.00	1
B. On	22.00	50.00	-30.00	-30.00	-50.00	-50.00	1
C. Off	50.00	70.00	-30.00	-30.00	-50.00	-50.00	1
D. Off	70.00	90.00	-30.00	-30.00	-50.00	-50.00	1
E. Off	90.00	100.00	-30.00	-30.00	-50.00	-50.00	1

a. **Res BW** is set to 100 kHz, **Fail Mask** is set to Rel, and **Abs Stop** and **Rel Stop** are both set to **Couple**.

**Offset** Select the offset pairs (upper and lower) that the softkeys will affect, and displays the memory selection menu from **A** to **E** (the analyzer can store up to 5 sets of values for **Start Freq**, **Stop Freq**, **Sweep Time**, **Res BW**, **Meas BW**, **Abs Start**, **Abs Stop**, etc.). Press **Offset** to select the letter of the desired offset is underlined. Only one selection at a time is shown on this key label.

Key access: **Meas** > **More** > **Spectrum Emission Mask** > **Offset/Limits**

**Start Freq On Off** Specifies the inner limit (frequency closest to the carrier) for both segments of the specified offset pair. When **Start Freq (Off)** is selected, the offset pair is not measured.

Key access: **Meas** > **More** > **Spectrum Emission Mask** > **Offset/Limits**

**Stop Freq** Specifies the outer limit (frequency furthest from the carrier) for both segments of the specified offset pair. The minimum frequency difference between **Start Freq** and **Stop Freq** is limited to 100 Hz.

Key access: **Meas** > **More** > **Spectrum Emission Mask** > **Offset/Limits**

**Sweep Time Auto Man** Specifies the sweep time for the currently selected offset, and toggles this function between **Auto** and **Manual** for each offset.

Key access: **Meas** > **More** > **Spectrum Emission Mask** > **Offset/Limits**

- Res BW  
Auto Man** Specifies the resolution bandwidth used in measuring the offset pair. When set to **Auto**, the Res BW from the default tables for “**Offset/Limits**” on page 128 are used. When set to **Man**, the allowed range is 1 kHz to 1MHz.  
Key access: **Meas** > **More** > **Spectrum Emission Mask** > **Offset/Limits**
- Abs Start** To enter an absolute level limit at **Start Freq** for the currently selected offset ranging from -200.00 to +50.00 dBm with 4 significant digits.  
Key access: **Meas** > **More** > **Spectrum Emission Mask** > **Offset/Limits** > **More**
- Abs Stop  
Couple Man** To enter an absolute level limit at **Stop Freq** for the currently selected offset ranging from -200.00 to +50.00 dBm with 4 significant digits, and to toggle this function between **Couple** and **Man**. If set to **Couple**, this is coupled to **Abs Start** to make a flat limit line. If set to **Man**, **Abs Start** and **Abs Stop** the user can enter different values to make a sloped limit line.  
Key access: **Meas** > **More** > **Spectrum Emission Mask** > **Offset/Limits** > **More**
- Rel Start** Enters a relative level limit at **Start Freq** ranging from -150.00 to +50.00 dBc with 4 significant digits.  
Key access: **Meas** > **More** > **Spectrum Emission Mask** > **Offset/Limits** > **More**
- Rel Stop  
Couple Man** Enters a relative level limit at **Stop Freq** ranging from -150.00 to +50.00 dBc with 4 significant digits, and to toggle this function between **Couple** and **Man**. If set to **Couple**, this is coupled to **Rel Start** to make a flat limit line. If set to **Man**, **Rel Start** and **Rel Stop** the user can enter different values to make a sloped limit line.  
Key access: **Meas** > **More** > **Spectrum Emission Mask** > **Offset/Limits** > **More**
- Fail Mask** Displays the menu to select one of the following logic keys for fail conditions between the measurement results and the test limits: **Absolute**, **Relative**, **Abs AND Rel**, and **Abs OR Rel**.  
Key access: **Meas** > **More** > **Spectrum Emission Mask** > **Offset/Limits** > **More** > **More**

- Absolute** Sets the limit test to show Fail if one offset is larger than the corresponding limit for **Abs Start** and/or **Abs Stop**. This is the default selection for each offset for BTS measurements.
- Relative** Sets the limit test to show Fail if one offsets spectrum emission mask measurement results is larger than the corresponding limit for **Rel Start** and/or **Rel Stop**.
- Abs AND Rel** Set the limit test to show Fail if one offset's spectrum emission mask measurement results is larger than both the corresponding limit for **Abs Start** and **Abs Stop** and the limit for **Rel Start** and **Rel Stop**.
- Abs OR Rel** Set the limit test to show Fail if one offset's the absolute spectrum emission mask measurement results is larger than the corresponding limit for **Abs Start** and **Abs Stop** or the limit for **Rel Start** and **Rel Stop**.
- Meas BW** Specifies the bandwidth to use when measuring the offset. When using the front panel, only the currently selected offset is affected. All the offsets are affected when remote control. This is the multiplier applied to the resolution bandwidth to determine the bandwidth to integrate when calculating the power. Meas BW is now restricted to be 1 and not changeable.
- Key access: **Meas** > **More** > **Spectrum Emission Mask** > **Offset/Limits** > **More** > **More**

# MODE

Selects the measurement mode of your analyzer.

**Spectrum Analyzer** mode is the default mode and is for general purpose measurement use.

## Tracking Generator

Accesses the tracking generator functions. (Option TG3)

Key access: **MODE**

### Amplitude TG On Off

Activates (**On**) or deactivates (**Off**) the tracking generator output. The power level can then be adjusted using the numeric keypad, arrow keys or knob. Pressing any digit, 0 through 9, on the numeric keypad brings up the selected terminator menu. The output level range is -30 dBm to 0 dBm.

Key access: **MODE** > **Tracking Generator**

### Attenuation

To set the output attenuation level of the tracking generator using the tracking generator output attenuator. The available level is 0 to 30 dB in 6 dB steps. The default setting is 18 dB.

Key access: **MODE** > **Tracking Generator**

### Amptd Offset On Off

**Amptd Offset (On)** allows you to offset the displayed power of the tracking generator. Using the amplitude offset capability of the tracking generator allows you to take system losses or gains into account, thereby displaying the actual power delivered to the device under test.

Key access: **MODE** > **Tracking Generator**

**Amptd Step Auto Man** To set the step size of the power level range of the tracking generator. The default setting is one vertical scale division when in a logarithmic amplitude scale. Key access: **MODE** > **Tracking Generator**

**Power Sweep** Sweep the output offset of the tracking generator. The analyzer continues to sweep the linear change between start and stop frequency when power sweep is on. The input range is 0 dB to 10 dB. Key access: **MODE** > **Tracking Generator** > **More**

**Normalize** Accesses the following softkeys.

**Store Ref (1->3)** Copies trace 1 into trace 3. Softkey menu **Store Ref (1->3)** must be pressed before pressing **Normalize (On)**.

**Normalize On Off** Activates the normalize function. On each sweep, the normalized trace (Trace 3) is subtracted from Trace 1 and the result is added to the normalized reference level.

The trace data is normalized with respect to the normalized reference level, even if the value of the normalized reference level is changed. This function remains in effect on all subsequent sweeps until it is turned off.

The normalize function is most useful for applying correction data to a trace while making a stimulus response measurement with a tracking generator. For example, connect the cables and a thru line, in place of the device to be measured,

**NOTE**

Trace 1 should be in clear write mode prior to setting normalize to on.

between the tracking generator and the analyzer input. Notice that the frequency response is not perfectly flat, showing the response of the cables, as well as the flatness of both the tracking generator and the analyzer. Now press **Store Ref (1->3)**, **Normalize (On)**. Notice that the displayed trace is now flat, or normalized. The position of the normalized trace can now be moved to a different position on the display by changing the normalized reference position. This may be useful if the device to be tested has positive gain, such as an amplifier. Now, replace the thru line with the device under test, and an accurate measurement of the gain or loss can be made.

- Norm Ref Lvl** Sets the level (in dB) of the normalized reference.
- Norm Ref Posn** Offsets the displayed trace without affecting the instrument gain or attenuation settings. This allows the displayed trace to be moved without decreasing measurement accuracy. The normalized reference position is indicated with a (>) character on the left side of the display and a (<) character on the right side of the display.
- Ref Trace View Blank** Allows you to view or blank the reference trace on the display.

**Tracking Peak** Activates a routine that automatically adjusts fine frequency tracking to obtain the peak response of the tracking generator on the spectrum analyzer display. Tracking Peak is performed in the current resolution bandwidth.

Key access: **MODE** > **Tracking Generator** > **More**

**Man Track adj** Allows you to manually adjust the frequency of the tracking generator oscillator using the step keys, knob, or numeric keypad. The tracking adjust is tuned to maximize the amplitude of the trace.

Key access: **MODE** > **Tracking Generator** > **More**

**NOTE**

When in the Tracking Generator mode, resolution bandwidths < 30 kHz are not available.

---



## Power Meter

Use the arrow keys to highlight the mode and press **[ENTER]** to make a measurement using the power meter function.

When this mode is selected, the power meter related softkey menu will be displayed and many of the instrument hardkeys will be disabled as they are not necessary for this mode.

Key access: **MODE**

**Zero/Cal** Accesses the associated Zeroing submenu.

Key access: **MODE** > **Power Meter**

**Zero** Makes a Zero operation of the power sensor. The U2000 Series USB Power Sensors have their sensor calibration tables stored in non-volatile memory which means that the reference calibration factor is automatically loaded upon power-up.

Key access: **MODE** > **Power Meter** > **Zero/Cal**

**Zero Type** Toggles the zeroing type of the Power Sensor between internal and external. When this type is set to **EXT**, pressing **Zero** will bring up a message which indicates the external signal need be pulled out. This setting is not affected by the preset in Power Meter menu.

Key access: **MODE** > **Power Meter** > **Zero/Cal**

**Meas Disp** Accesses the Meas Disp submenu for defining the display range and resolution while in Power Meter mode.

Key access: **MODE** > **Power Meter**





- Disp Range** Accesses the associated Disp Range submenu.  
 Key access: **MODE** > **Power Meter** > **Meas Disp**
- Auto Range** Toggles the auto range function between On and Off. When the Auto Range is set to On, the Top and Bottom value of the power meter's display range will be set automatically according to the measurement data:  

$$\text{Top} = \text{Max. data} + 0.5$$

$$\text{Bottom} = \text{Min. data} - 0.5$$
 The default setting is Off.
- Top** Sets the top value of the power meter' display range.  
 Range from (Bottom + 0.01) to 200 dBm.  
 The default value is 20 dBm.
- Bottom** Sets the bottom value of the power meter' display range.  
 Range from - 200 to (Top - 0.01) dBm.  
 The default value is - 70 dBm.

**Resolution** Accesses the associated Resolution submenu.  
**1 2 3 4** When the measurement suffix is W or %, this parameter represents the number of significant digits. When the measurement suffix is dB or dBm, 1 through 4 represents 1, 0.1, 0.01, and 0.001 dB respectively. The default value is 3.  
 Key access: **MODE** > **Power Meter**

**Meas Setup** Accesses the power meter measurement setup submenu.  
 Key access: **MODE** > **Power Meter**

- Dis Mode** Changes the display mode between **Meter** and **Chart**.
- Meter Chart** The default mode is Meter.  
Key access:  > **Power Meter** > **Meas Setup**
- Chart View** Accesses the Chart View submenu. This soft key is disabled when the measurement is in process or if the display mode is set to **Meter**.  
This submenu is used to view the measurement chart.  
Key access:  > **Power Meter** > **Meas Setup**
- Home** View the first 21 points of current measurement chart.
- End** View the last 21 points of current measurement chart.
- Prev** View the previous points of the chart.
- Next** View the next points of the chart.
- Pause/Continue** Continues or pauses the current measurement.  
When the measurement is in process, this softkey is displayed as “Pause”; when the measurement is paused, the softkey is displayed as “Continue”.  
Key access:  > **Power Meter** > **Meas Setup**
- Preset** Sets the Power Meter softkey menu options to the preset conditions. This softkey is the hotkey for  > **{Preset}**.

## ASK/FSK Modulation Analysis

Use the arrow keys to highlight the mode you need and press **[ENTER]** as a terminator. When this mode is selected, the ASK/FSK modulation analysis menu will be displayed.

- Carrier Freq** Sets the modulated carrier frequency.  
Key access: **MODE** > **ASK/FSK Modulation Analysis**
- Symbol Rate** This specifies the fundamental symbol rate of the signal to be analyzed. The values should be positive. The non-positive value will be converted to 1Hz. The measurement accuracy will be impacted if this value isn't set precisely.  
Key access: **MODE** > **ASK/FSK Modulation Analysis**
- Filter Setup** Accesses the Filter setup submenu for further configuration.  
Key access: **MODE** > **ASK/FSK Modulation Analysis**
- Meas Filter** Selects the Measure Filter as Root Nyquist, Nyquist, and Gaussian.
- Ref Filter** Selects the Measure Filter as Root Nyquist, Nyquist, and Gaussian.
- Alpha/BbT** Sets the root-off factor  $\alpha$  for Root Nyquist and Nyquist filter or BbT for Gaussian filter.
- Filter Symbols** Sets the symbol numbers for the selected filter.  
The allowed value range is from 2 to 25.
- View** Accesses the submenu to select four display mode:  
Symbol - displays the binary symbol in full screen/window.  
Waveform - displays the signal waveform.  
ASK Error - displays the ASK error.  
Eye Diagram - Displays the Eye diagram.  
Key access: **MODE** > **ASK/FSK Modulation Analysis**

- X Scale** Accesses the submenu to configure the X scale parameters:  
**Scale/Div** sets the number of symbols in one division.  
**Ref Value** sets the starting value in term of times at the reference position.  
**Ref position** sets the display reference position to either Left, Ctr (center), or Right. If the **Auto scale** key is set to on, these parameters are adjusted automatically according to the measurement result.  
 Key access: **MODE** > **ASK/FSK Modulation Analysis**
- Y Scale** Accesses the submenu to configure the X scale parameters:  
**Scale/Div** sets the number of symbols in one division.  
**Ref Value** sets the starting value in term of times at the reference position.  
**Ref position** sets the display reference position to either Top, Ctr (center), or Bottom.  
 The **Ext Gain** is set to add the external gain to the test result. If the **Auto scale** key is set to on, these parameters are adjusted automatically according to the measurement result.  
 Key access: **MODE** > **ASK/FSK Modulation Analysis**
- Meas Length** Sets the number of symbols which will be used in calculating the measurement.  
 Key access: **MODE** > **ASK/FSK Modulation Analysis** > **More**
- Average On Off** Specifies the display measurement result format. When the Average Number is set to off, the column title "Average" in numerical results view will be changed to "Current".  
 Key access: **MODE** > **ASK/FSK Modulation Analysis** > **More**

**Trigger** Enables you to configure the trigger. When using a trigger source other than Free Run, the analyzer will begin a sweep only with the selected trigger conditions are met. A trigger event is defined as the point at which your trigger source signal meets the specified trigger level.

Free Run - New sweep starts as soon as possible after the current sweep ends.

RF Trigger - Activates the trigger condition that starts the next sweep if the detected RF envelope voltage rises to a level set by the RF trigger level.

Ext Rise/Fall - Activates the trigger condition that will start a sweep when the external voltage passes through 2 volts. The external trigger signal must be a 0 V to +5 V TTL signal. Sets the trigger polarity to positive/negative.

Trig Delay - Allows you to set and turn on or off a delay, during which the analyzer will wait to begin a sweep after receiving an external trigger signal.

Key access: **MODE** > **ASK/FSK Modulation Analysis** > **More**

**Limits** Set a limit value to warn you if the measured value exceeds the value specified here. The test result will be in purple if this result exceeds the corresponding limit value.

Limit - Turns on/off the limit function

CarrPow Up - Sets the carrier power upper limit

FreqDev Up/Low - Sets the frequency deviation upper/lower limit

CarrFreOff Up - Sets the carrier frequency offset upper limit

Key access: **MODE** > **ASK/FSK Modulation Analysis** > **More**

**Sweep** Toggle the sweep type between single and continuous in ASK/FSK mode. When this softkey is set to Single, press the next **Single** softkey to execute a new sweep as soon as the trigger condition is met.

Key access: **MODE** > **ASK/FSK Modulation Analysis** > **More**





- Single** When the analyzer is in continuous sweep mode, pressing this softkey will change the sweep setting to single sweep. It will then begin a sweep after the trigger conditions are met. If the analyzer is already in single sweep, pressing this softkey will execute a new sweep as soon as the trigger condition is met. If average is on pressing this softkey will halt averaging of the current value, and then continue averaging from the current count number when a single sweep function triggers.  
Key access: **MODE** > **ASK/FSK Modulation Analysis** > **More**
- CarrFreq Step** Changes the step size for the center frequency function. Once a step size has been selected and the center frequency function is activated, the arrow keys change the center frequency by the step-size value. The step size function is useful for finding harmonics and sidebands beyond the current frequency span of the analyzer.  
Key access: **MODE** > **ASK/FSK Modulation Analysis** > **More** > **More**
- Auto CarrFreq On Off** This function can remedy the carrier frequency deviation when the deviation less than symbol rate 5.  
Key access: **MODE** > **ASK/FSK Modulation Analysis** > **More** > **More**
- Attenuation Auto Man** Toggles the input attenuation between Auto or Man. Please refer to [page 86](#) for further information.  
Key access: **MODE** > **ASK/FSK Modulation Analysis** > **More** > **More**
- Preamp On Off** Toggles the internal preamp between On and Off. Please refer to for [page 87](#) further information.  
Key access: **MODE** > **ASK/FSK Modulation Analysis** > **More** > **More**

## Peak Search





Places a marker on the highest peak based on the settings of the **“Search Criteria”** on page 145. Refer to **“Peak Search Type”** on page 146, for more information on the effect of settings.

### NOTE

All peak search functions ignore the LO feed through signal. The process for determining if the Peak is the LO feed through takes into account Start Frequency, Span, Resolution Bandwidth, Resolution Bandwidth shape factor, and Frequency Accuracy. If there is no point of inflection within the LO feed through range, the point on the trace with maximum amplitude, that is higher in frequency than the LO feed through, will be selected.

- 
- |                      |  |
|----------------------|--|
| <b>Peak Search</b>   | Performs peak search as described above.<br>Key access:   |
| <b>Next Peak</b>     | Places the marker on the next highest peak. The signal peak must exceed the peak threshold value by the peak excursion value. If there is no peak, the marker will not move.<br>Key access:   |
| <b>Next Pk Right</b> | Moves the marker to the next peak to the right of the current marker position. The signal peak must exceed the peak threshold value by the peak excursion value. If there is no peak to the right, the marker will not move and the “No Peak Found” error message will appear on the display.<br>Key access:  |
| <b>Next Pk Left</b>  | Moves the marker to the next peak to the left of the current marker position. The signal peak must exceed the peak threshold value by the peak excursion value. If there is no peak to the left, the marker will not move and the “No Peak Found” error message will appear on the display.<br>Key access:    |



- Min Search** Moves the active marker to the minimum detected amplitude.  
Key access: 
- Pk-Pk Search** Finds and displays the frequency (or time, if in zero span), and amplitude differences between the highest and lowest trace points.  
Key access: 
- Continuous Pk On Off** When **Continuous Pk** is **on**, the marker will remain on the peak signal even if the frequency of that signal changes. The marker will remain on that signal as long as the amplitude of the signal does not change by more than 3 dB from one sweep to another.  
If the signal is lost, the marker will attempt to find it again and maintain on the peak. If there are other signals on screen near the same amplitude, one of them may be found instead. Signals near 0 Hz cannot be maintained effectively. This function is intended to maintain the marker on signals with a frequency that is changing, and an amplitude that is not changing.  
Key access:  **> More**
- N dB Points On Off** Activates the N dB function. Pressing **N dB Points (On)** activates two arrows that are N dB down from the marker. The frequency difference between the two arrows will be displayed in the upper right-hand corner of the display.  
Key access:  **> More**
- Search Criteria** Accesses the submenu to set the criteria for peak search.  
Key access:  **> More**
- Peak Excursion** Sets the minimum amplitude variation of signals that the marker identifies as a peak. If a value of 10 dB is selected, the marker moves only to peaks that rise and fall more than 10 dB above the peak threshold value. When the peak excursion is 6 dB or higher,

**NOTE**

Two signal peaks, which are so close together that the amplitude drop between them is less than the peak-excursion value, are not recognized as two peaks. A signal peak is recognized only if it has a peak excursion drop above the noise floor, on both sides of the signal.

the marker-peak does not recognize signals less than peak-excursion value above the noise floor. To correct this, when measuring signals near the noise floor, reduce the excursion value. To prevent the marker from identifying noise as signals, reduce the noise floor variance less than the peak-excursion value by reducing the video bandwidth or by using video averaging.

Key access:  > **More > Search Criteria**

**Peak Threshold**

Sets the minimum amplitude that the marker can identify as a peak. For example, if set to -90 dBm, the marker moves only to peaks that rise and fall more than the peak excursion above -90 dBm. Only functional when in Excursion and Threshold marker mode.

Key access:  > **More > Search Criteria**

**Threshold Hidden**

Hides the threshold line from being displayed on the screen.

Key access:  > **More > Search Criteria**

**Peak Search Type**

Selects the peak search mode.

Key access:  > **More > Search Criteria**

**Max Value** A Peak search with **Max Value** type places a marker on the highest peak, excluding the LO feedthrough peak.

**Max Value** A Peak search with **Max Value** type places a marker on the highest peak, excluding the LO feedthrough peak.

**Excursion & Threshold** When **Peak Search Type** is **Excursion & Threshold**, a peak search places a marker on a peak that meets the **Peak Excursion** and **Peak Threshold** parameters. If **Peak Search Type** is **Excursion & Threshold** and no peak satisfies the selected parameters, a marker is placed at the center of the trace, and the error message, “No Peak Found” will appear.

**Peak Table** Accesses the following **Peak Table** softkeys to set a peak table.

Key access:  > **More**

**Peak Table On Off** Displays a list of up to 12 signal peaks that is updated at the end of each sweep. The peak table function works with trace 1 only.

Key access:  > **More** > **Peak Table**

**Peak Sort Freq Amptd** Switches the peak table sorting routine between listing the peaks in order by descending amplitude or frequency.

Key access:  > **More** > **Peak Table**

## Preset/System

Accesses the Preset and System softkeys. When the analyzer is in the remote mode, pressing  returns the analyzer to the local control mode and enables front-panel inputs.

**Preset** Provides a known state of the instrument for making measurements. The analyzer allows you to select whether a user preset, or factory preset is performed.

If **Preset Type** is set to **Factory**, pressing  > **Preset** performs a factory preset, which performs the following:

- Resets the analyzer to Spectrum Analyzer (SA) mode
- Brings up the **Frequency** menu
- Sets certain conditions to their default values
- Clears both the input and output buffers and clears all trace data
- Sets the amplitude values of trace 2, 3 and 4 to the bottom of the screen
- Turn amplitude-correction factors off, but remain in analyzer memory
- Turn limit line testing off, but the limit line tables remain in analyzer memory







See Table **Factory Preset States** as follows for the conditions established by performing a factory preset.







When **Preset Type** is set to **User**, pressing  > **Preset** displays the softkeys **User Preset** and **Factory Preset**, you then select the specific preset as you need.









Key access: 

### Factory Preset State







Attenuation	20 dB(Auto)	Average Type	Video (Auto)
Center frequency	1.5 GHz	Averaging	1(Off)
CF step size	300 MHz	Peak Excursion	6 dB
Start Frequency	0 Hz	Peak Threshold	-90 dBm
Stop Frequency	3 GHz	Peak Search Type	Max Value
Signal Track	Off	Peak Table	Off
Span	3 GHz	Peak Sort	Amplitude
Reference level	0 dBm	Continuous Pk	Off
Log scale/Division	10 dB	Delta Pair	Delta
Int Preamp	Off	Span Pair	Center
Trace 1	Clear Write	Trigger	Free Run
Trace 2, 3, 4	Blank	Markers	Normal(Off)
Sweep Time	346.7 ms(Auto)	Marker Delta	Off
Sweep	Continuous	Marker Table	Off
Limit	Off	Measure	Meas Off
Limit line testing	Off	File Catalog	Local
Limit point	0	File Type	State
Detector	Peak(Auto)	File Sort	By Date
Display line	-25 dBm(Off)	Phase Noise	Off
Video bandwidth	3 MHz(Auto)	Optimize phase noise	Off
VBW/RBW ratio	1.000 (Auto)	Frequency Counter	Off
Resolution bandwidth	3 MHz(Auto)	Frequency counter resolution	1 kHz(Auto)

- Pwr on/Preset** Accesses the following softkeys for the preset settings.  
 Key access: 
- Power on Last Preset** Determines the state of the analyzer when the analyzer is turned on. **Power On** set to **Preset** recalls the analyzer settings previously with the **Preset** function. **Power On** set to **Last** recalls the analyzer settings when previously power off.  
 Key access:  > **Pwr on/Preset**
- Preset Type** Selects **User** or **Factory** preset settings.  
 Key access:  > **Pwr on/Preset**
- User** Pressing **Preset** recalls the analyzer settings defined by **Save User Preset**.
- Factory** Pressing **Preset** recalls the analyzer settings originally set at the factory.
- Save User Preset** Saves the active settings of the analyzer into the User Preset register. To recall these settings, select **Preset Type** to **User**.  
 Key access:  > **Pwr on/Preset**
- Alignment** Accesses the following softkeys that align the internal circuitry of the analyzer, load default values for the alignment system, and adjust the 10 MHz reference.  
 Key access: 
- Align** Accesses the **Align** softkeys.  
 Key access:  > **Alignment**
- All (Ext Cable)** Initiates the alignment of systems with a cable connected from the **CAL OUT** to **RF IN** (Except option TG3).
- CAL OUT On Off** Turns the internal amplitude reference signal on or off. When this signal is on, the RF input is disabled.

- Upgrade** Enables the firmware upgrade process once the USB disk with the firmware upgrade package plug connected.  
Key access: 
- Language** Accesses the softkeys for selecting the screen menu language. In addition to English, there are ten more user-selectable, on-screen languages, including Chinese, Japanese, Korean and a number of European languages.  
Key access: 
- Diagnostics** Accesses the **Front Panel Test** softkey to verify the functionality of each front-panel key. The number next to each key name increments once each time the key is pressed. Rotating the knobs causes the number of pulses to be counted. Press **Return** will go back to the main menu.  
Key access: 
- Show System** Displays the number and description of the options installed in your analyzer. It also displays the instrument model number, product number, serial number, the date of production, etc.  
Key access:  **> More**
- Show Hardware** Provides detailed information about the hardware installed on the analyzer, including the model number and firmware revision.  
Key access:  **> More**
- Show Software** Provides the detailed information on the installed software.  
Key access:  **> More**
- Show Errors** Accesses a list of the 100 most recent errors reported. The most recent error will appear at the bottom of the list. The first error listed will be removed if the error list is longer than 20 entries. If the same error occurs continuously, that error message will not be added repeatedly to the list. Refer to “[Instrument Messages](#)” on page 159 for details.  
Key access:  **> More**

<b>Prev Page/ Next Page</b>	Access the previous/next page of error messages. Key access:  > <b>More</b> > <b>Show Errors</b>
<b>Clear Error Queue</b>	Clears all the errors in the errors queue. Key access:  > <b>More</b> > <b>Show Errors</b>
<b>Time/Date</b>	Accesses the following <b>Time/Date</b> menu keys used to set and display the real-time clock: Key access:  > <b>More</b>
<b>Time/Date On Off</b>	Toggles the time/date display between on and off. Key access:  > <b>More</b> > <b>Time/Date</b>
<b>Date Format MDY DMY</b>	Changes the display format of date from month-day-year to day-month-year. Key access:  > <b>More</b> > <b>Time/Date</b>
<b>Set Time</b>	sets the time of the real-time clock. Enter the time in 24 hour HHMMSS format. Valid hour (HH) values are from 00 to 23. Valid minute (MM) and second (SS) values are from 00 to 59. Key access:  > <b>More</b> > <b>Time/Date</b>
<b>Set Date</b>	sets the date of the real-time clock. Enter the date in the YYYYMMDD format. Valid year (YYYY) values are 0000 through 9999. Valid month (MM) values are from 01 to 12, and valid day values are from 01 to 31. Key access:  > <b>More</b> > <b>Time/Date</b>
<b>IO Config</b>	Toggles the IO port between <b>USB</b> , <b>LAN</b> and <b>GPIB</b> (option) for remote control. Key access:  > <b>More</b>
<b>Licensing</b>	Accesses the security system to enable licensing for individual options. A user may not turn off an option using this system. Once an option has been licensed for a given analyzer, it cannot be transferred to a different analyzer. Key access:  > <b>More</b> > <b>More</b>



- Option** Allows you to key in a three-character option number. The option number will appear on the second line of the **Option** key.  
Key access:  > **More** > **More** > **Licensing**
- License Key** Allows you to key in a license key number. The license key number appears on the second line of the **License Key** softkey.  
Key access:  > **More** > **More** > **Licensing**
- Activate License** Activates the license for the option whose number was previously input in **License Key**. If the entry is correct, the option will be enabled and the message: “Option activated” will appear in the status line of your display. The option number and license key numbers will also clear from the **License Key** and **Option** key. If the entry is incorrect, the error message “License key invalid” appears in the status line of the display. Edit the option and/or license key number until they are correct.  
Key access:  > **More** > **More** > **Licensing**
- GPIB Address** Sets the GPIB address for the analyzer.  
Key access:  > **More** > **More**
- VGA OUTPUT** Toggles the VGA output port between on and off for video signal output.  
Key access:  > **More** > **More**
- Brightness** Adjusts the display brightness between high, middle and low.  
Key access:  > **More** > **More**
- IP Admin** Access the submenu to configure the TCP/IP parameters for remote control via LAN, such as: IP address, Static/DHCP IP, Gateway and subnet mask. Once the setting is finished, press **Apply** to activate the configuration.  
Key access:  > **More** > **More**

## SPAN

Accesses the span function and the submenu softkeys for span functions. Pressing **SPAN** changes the frequency range symmetrically about the center frequency. The frequency-span readout describes the total displayed frequency range. To determine frequency span per horizontal graticule division, divide the frequency span by 10.

**Span** Enter the span frequency range value.

Key access: **SPAN**

**Full Span** Changes the span to full span showing the full frequency range of the analyzer. Full span sets **Signal Track, Marker** function **off**.

Key access: **SPAN**

**Zero Span** Changes the frequency span to zero. In this mode, the current center frequency is displayed in the time domain (the x-axis is displayed in units of time), like a conventional oscilloscope. Zero span sets **Signal Track (Off)**.

Key access: **SPAN**

**Last Span** Changes the span to the previous span setting.

Key access: **SPAN**

**Demod** Accesses the menu keys to select **AM** demodulation, **FM** demodulation. It also accesses the **Speaker Vol** softkey described below.



Key access: **SPAN**

### NOTE

The **Demod** menu key only appears when the **SPAN** is set to **Zero Span**.

- AM  
On Off** Activating AM demodulation turns off FM demodulation (if it is on).  
Key access: **SPAN** > **Demod**
- FM  
On Off** Turning FM demodulation on turns off AM demodulation (if it is on). For best results, Turn on the optional Internal Preamplifier, set the RBW to 100 kHz and Attenuation to 0 dB.  
Key access: **SPAN** > **Demod**
- Speaker Vol** Press this softkey to set the speaker volume of the demodulated signal.  
Key access: **SPAN** > **Demod**

## Sweep/Trig

- Accesses the Sweep/Trigger softkeys for selection of the sweep mode and trigger mode of the analyzer. The softkey menu selections are defined as follows:
- Sweep Time** Selects the length of time the analyzer takes to tune across the displayed frequency span (or, in zero span, the time the analyzer takes to sweep the full screen). Reducing the sweep time increases the sweep rate. Change the sweep time by using the arrow keys, the knob, or the numeric keypad.
- Auto Man** In non-zero spans, when the sweep time is auto-coupled, the analyzer selects the optimum (shortest) sweep time for the current settings. This selection process is influenced by several factors:
- The max. tuning rate of the spectrum analyzer
  - The selected resolution and video bandwidth filters
  - The max. sample rate of the analog-to-digital converter
  - The number of trace points
  - The amplitude scale (logarithmic or linear)
  - The detector mode
- The user may select a sweep time less than the auto-coupled value; however this may generate measurement errors. The minimum sweep time is 50 ms.
- In zero span, the minimum sweep time is determined by the maximum sample rate of the ADC and the number of sweep points. The minimum sweep time is 2 microseconds. The maximum sweep time is 4000 seconds.
- Key access: 
- Sweep Single** Pressing **Sweep Single** puts the analyzer in single-sweep mode. Press **Sweep Single** to initiate a sweep when in single-sweep mode.
- Key access: 
- Sweep Cont** Selecting continuous sweep causes repeated sweeps to be triggered. Pressing **Preset** (When **Preset Type** is set to **Factory**) sets the sweep mode to continuous sweep.
- Key access: 

**Free Run** New sweep starts as soon as possible after the current sweep ends.

Key access:  > **More**

**Video** Activates the trigger condition that starts the next sweep if the detected RF envelope voltage rises to a level set by the video trigger level. When **Video** is pressed, a line appears on the display. The analyzer triggers when the input signal exceeds the trigger level at the left edge of the display. Change the trigger level by using the arrow keys, the knob, or the numeric keypad.

Key access:  > **More**

#### NOTE

This function is not available when the Resolution Bandwidth is less than 1 kHz. Selecting a Resolution Bandwidth less than 1 kHz while in Video Trigger mode, changes the Trigger mode to Free Run.

**External Pos** Activates the trigger condition that will start a sweep when the external voltage (connected to **EXT TRG IN** on the rear panel) passes through approximately 2 volts. The external trigger signal must be a 0 V to +5 V TTL signal. Sets the trigger polarity to positive.

Key access:  > **More**

**External Neg** Sets the trigger polarity to negative.

Key access:  > **More**

**Trig Offset On Off** Allows you to set and turn on or off an offset value from the trigger point of the sweep at which to begin storing data in the trace of the analyzer. The offset is specified as a function of time, and permits positive (pre trigger) and negative (post trigger) values to be specified.

Key Access:  > **More**

#### NOTE

This function is only available when in Zero Span. The value and state is saved if Zero Span is exited and restored when Zero Span is reselected.

## View/Trace

Accesses the trace keys to store and manipulate trace information. Each trace consists of a series of points in which amplitude data is stored. The analyzer updates the information for any active trace with each sweep.

### Select Trace 1 2 3 4

Selects the trace for current use.

Key access: 

### Clear Write

Erases any data previously stored in the selected trace, then continuously displays any signals during each sweep of the analyzer. This function is activated for trace 1 at power-on and **Factory Preset**.

Key access: 

### Max Hold

Retains the maximum level for each trace point of the selected trace. Updates the trace point value if a new maximum level is detected in successive sweeps.

Key access: 

### Min Hold

Retains the minimum level for each trace point of the selected trace. Updates each minimum trace point if a new minimum level is detected in following sweeps.

Key access: 

### View

Holds and displays the amplitude data of the selected trace. The trace register is not updated as the analyzer sweeps. press **View** to retrieve a stored trace previously deactivated by pressing **Blank**.

Key access: 

### Blank

Stores the amplitude data for the selected trace, then removes the trace from the display. The selected trace register no longer updates as the analyzer sweeps. To activate this function for traces 2, 3 and 4 at power-on press **Preset** (when **Preset Type** is set to **Factory**).

Key access: 



## 4 Key Reference



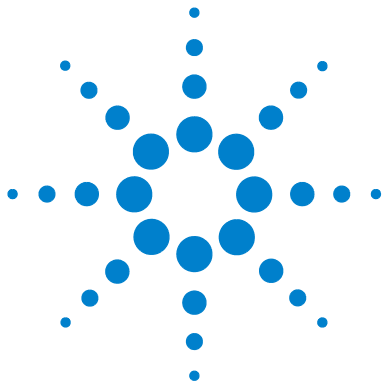

## 5 Instrument Messages

Overview	160
Command Errors	161
Execution Conflict	163
Device-Specific Errors	165

### Overview

If an improper operation occurs during the instrument configuration, a message will appear on the status line indicating the incident and the how the spectrum analyzer corrected the setting automatically. press  > **More** > **Show errors** to read the specific descriptions of those messages.

### Example

In this example, a failure explanation is generally included with each error to further define its meaning. The instrument messages in this guide are listed numerically.

<Number>	<Code>	<Message>
1.	-330	Self-test failed
		A self-test failure occurred.
		<Explanation in manual>

## Command Errors

The messages listed below are command errors, which are saved into local registers.

- 100 Command error  
An unrecognized command or data type was encountered. This message is used when the device cannot detect more specifics described for errors -101 to -109.
- 101 Invalid character  
A syntactic element contains an invalid character.
- 102 Syntax error  
An unrecognized command or data type was encountered.
- 103 Invalid separator  
The parser was expecting a separator and encountered an illegal character.
- 104 Data type error  
The parser recognized a data element that is not allowed.
- 108 Parameter not allowed  
More parameters were received than expected for the header. For example, the \*ESE common command only accepts one parameter, so receiving \*ESE 0,1 is not allowed.
- 109 Missing parameter  
Fewer parameters were received than required for the header. For example, the \*ESE common command requires one parameter, so receiving \*ESE is not allowed.
- 110 Command header error  
An error was detected in the header. This message is used when the device cannot detect more specifics described for errors -111 to -119.

- 112 Program mnemonic too long  
The header contains more than 12 characters.
- 113 Undefined header  
The header is correct in syntax, but it is undefined for this device.
- 128 Numeric data not allowed  
A legal numeric data element was received, but the device does not accept one in this position for the header.
- 130 Suffix error  
This error is generated when parsing a suffix. This message is used when the device cannot detect more specifics described for errors -131 to -139.
- 131 Invalid suffix  
The suffix does not follow the syntax described in *IEEE 488.2*, or the suffix is inappropriate for the device.
- 134 Suffix too long  
The suffix contained more than 12 characters.
- 138 Suffix not allowed  
A suffix was encountered after a numeric element which does not allow suffixes.
- 144 Character data too long  
The character data element contains more than 12 characters.
- 148 Character data not allowed  
A legal character data element was encountered where prohibited by the device.

## Execution Conflict

The system messages listed below are execution conflicts, indicating settings conflict during your operation.

- 200 Execution Error  
This is the generic syntax error for devices that cannot detect more specific errors.
- 222 Data out of range  
A legal program data element was parsed but could not be executed because the interpreted value was outside the legal range defined by the device. The displayed results may be clipped.
- 223 Too much data not all points entered  
Indicates that a legal program data element of block, expression, or string type was received that contained more data than the device could handle due to memory or related device-specific requirements.
- 224 Illegal parameter value  
An attempt was made to select a user file that contains 0 bits. Select another user file that contains at least 1 bit.
- 241 Hardware missing  
Missing device hardware. For example, the RF board is not installed.
- 253 Corrupt media  
A source media (possibly EEPROM) for a data file is corrupt. This error is usually seen in conjunction with errors concerning a certain file.
- 300 Device-specific error  
This is the device-specific error for devices that cannot detect more specific errors.

## 5 Instrument Messages

-330 Self-test failed

A self-test failure occurred. Report this error to Agilent Technologies.

-340 calibration failed

An expected file was not found while trying to load internal calibration.

## Device-Specific Errors

- 102 Set 50 MHz signal < 0 dBm, do alignment again  
The 50 MHz energy is too high at the RF port for alignments to run. Reduce input power to less than 0 dBm and run alignments again.
- 104 1st LO Unlock  
The first LO on has lost phase lock. Report this error to the nearest Agilent Technologies sales or service office.
- 105 2nd LO Unlock  
The second LO has lost phase lock. Report this error to the nearest Agilent Technologies sales or service office.
- 201 Option not installed  
The desired operation cannot be performed because a required option is not installed.
- 204 TG Frequency Limit  
The tracking generator has reached the limit of its allowable frequency range.
- 211 RBW limited to 1 kHz when Span > 1 MHz  
In spans greater than 1 MHz, narrow (digital) resolution bandwidths, below 1 kHz, are not available.
- 213 Span limited to 1 MHz when RBW < 1 kHz  
In narrow (digital) resolution bandwidths, below 1 kHz, spans greater than 1 MHz are not available.
- 214 TG start freq is less than 9 kHz  
Tracking generator uncalibrated below 9 kHz.

- 215 TG start freq is less than 1/2 res bw  
Tracking generator uncalibrated at start frequencies below 1/2 the current resolution bandwidth.
- 224 Option not licensed  
The selected option requires a license. Refer to the installation procedures in the user guide provided for this particular option.
- 238 VBW filter or Average Detector cannot use both
- 501 RF over load  
Either increase input attenuation or decrease the input signal level.
- 502 IF over load  
Either increase input attenuation or decrease the input signal level.
- 604 File already exists  
You attempted to save to a file that already exists. Either delete or rename the existing file or select a new name, then try again.
- 605 Media is protected  
A save was attempted to a write-protected device.
- 610 File access is denied  
The file is protected or hidden and cannot be accessed.
- 612 File not found  
The analyzer could not find the specified file.
- 651 Connect TG OUT to RF IN  
Attempt to align the tracking generator without its output connected. Connect the **TG SOURCE** to **RF IN**.



- 652 Connect CAL OUT to RF IN  
you must connect the **CAL OUT** to **RF IN** with the appropriate cable.
- 751 Instrument state set to initial values  
While trying to load a trace or state, the state information was found to be in error. This may be because the state had been stored on a later revision of analyzer firmware. A default set of state variables was loaded instead. There is nothing wrong with the analyzer.
- 752 Unable to load state from file  
Attempt to load a state from a file failed.
- 753 Unable to save state to file  
Attempt to save a state to a file failed. See the associated error messages for the cause.
- 757 Unable to load user state  
A user preset failed, so the factory preset values were used. Save a valid state into user preset and try again.
- 758 Unable to save user state  
Attempt to save a user preset state failed.
- 760 Unable to query state  
Query of state over the remote interface was unsuccessful.
- 762 Unable to load file  
A failure occurred while loading a file.
- 764 Unable to save file  
Attempt to save a file failed; the file was not saved.

- 767 Fatal LDS error  
Attempt to initialize the instrument state has failed. Cycle instrument power. If this fails to correct the problem, contact your nearest Agilent Technologies service center.
- 768 Unable to load user state  
Attempt to load a state failed, because the state was saved with a measurement personality that is not currently loaded. Load the appropriate personality and try again.
- 770 Incorrect filename  
You sent a remote command to save a screen file but did not specify a valid extension.
- 780 No Peak Found  
No signal peak was found that meets the criteria under  **> Search Criteria.**
- 781 Video Trigger cannot be active  
You sent a remote command to do one of the following:
- Turn on video trigger while the Average Detector or a Marker Function is active.
  - Turn on the Average Detector or a Marker Function while Video Trigger is active.
- 782 Video Trigger cannot be used with Mkr Func  
Due to the Average Detector, the video Trigger cannot be used with Maker function.
- 783 Allowable span for current CF exceeded
- 784 Allowable CF for current span exceeded
- 805 Doing Alignment



## 6 Troubleshooting

This chapter includes information on how to check for a problem with your Agilent Technologies spectrum analyzer, and how to return it for service.

If you experience a problem or would like additional information about your analyzer, Agilent Technologies' worldwide organization is ready to provide the support you need.

## Check the basics

Before calling Agilent Technologies, or returning an analyzer for service, perform the quick checks listed below. This check may eliminate the problem.

- Is there power at the receptacle?
- Is the analyzer turned on? Listen for internal fan noise to determine if the analyzer cooling fan is running. Feel the rear side of the analyzer for air flow.
- If other equipment, cables, and connectors are being used with your spectrum analyzer, make sure they are connected properly and operating correctly.
- Review the measurement procedures being performed when the problem first appeared. Make sure all of the settings are correct.
- If the analyzer is not functioning as expected, return the analyzer to a known state by pressing **Preset**.

### NOTE

Some analyzer settings are not affected by a Preset. If you wish to reset the analyzer configuration to the state it was in when it was originally sent from the factory, press System, Power On/Preset, Preset Type, Factory. Then press the green Preset key on the front panel.

- Is the measurement being performed, and the results that are expected, within the specifications and capabilities of the analyzer? Refer to the *Technical Overview* for your analyzer.
- Is the analyzer displaying an error message? If so, refer to *User's Guide* for details.
- To meet specifications, the analyzer must be aligned. For more information on how to align the analyzer, refer to [“Perform a Time Base Calibration”](#) on page 23.

### WARNING

**No operator serviceable parts inside. Refer servicing to qualified personnel. To prevent electrical shock, do not remove covers.**

**NOTE**

If the analyzer is still under warranty or is covered by a maintenance contract, it will be repaired under the terms of the warranty or plan (the warranty is located at the front of this manual).

If the analyzer is no longer under warranty or is not covered by an Agilent Technologies maintenance plan, Agilent Technologies will notify you of the cost of the repair after examining the analyzer.

---

If a problem persists, please contact the Agilent Technologies office for further information and service.

## Warranty and Service Options

Agilent N9320B spectrum analyzer provides 1-year return-to-Agilent warranty as standard.

Agilent Technologies offers several optional maintenance plans to service your analyzer after the warranty has expired:

***R-51B-001-3C***

extends this service to 3 years.

***R-50C-011-3***

Agilent calibration upfront support plan, 3-year coverage.

The calibration cycle of N9320B spectrum analyzer is one year.

**NOTE**

A button cell provides power to the real time clock of the spectrum analyzer. It is not rechargeable. If you find your N9320B encounters a clock defect, please contact your nearest Agilent Customer Contact Center (CCC) for service.

---

## Contact Agilent Technologies

Agilent Technologies has offices around the world to provide you with complete support for your spectrum analyzer. To obtain servicing information or to order replacement parts, contact the Agilent Technologies customer contact center listed below. In any correspondence or telephone conversations, refer to your spectrum analyzer by its product number and full serial number.

Press  > **More** > **Show System** to find those information.

**Online assistance:** <http://www.agilent.com/find/assist>

### United States

(tel) 800 829 4444  
(fax) 800 829 4433

### Canada

(tel) 877 894 4414  
(fax) 800 746 4866

### China

(tel) 800 810 0189  
(fax) 800 820 2816

### Europe

(tel) +31 20 547 2323  
(fax) +31 20 547 2390

### Japan

(tel) +81 426 56 7832  
(fax) +81 426 56 7840

### Korea

(tel) 080 769 0800  
(fax) 080 769 0900

### Latin America

(tel) +1 (305) 269 7500

### Taiwan

(tel) 0800 047 866  
(fax) 0800 286 331

### Australia

(tel) 1 800 629 485  
(fax) +61 (3) 9210 5947

### Other Asia Pacific Countries

(tel) +65 6375 8100

(fax) +65 6755 0042

Email: [tm\\_ap@agilent.com](mailto:tm_ap@agilent.com)



## 7 Menu Maps

This chapter provides a visual representation of the front panel keys and their associated menu keys (in Spectrum Analyzer mode). Refer to [Chapter 4](#), “Key Reference,” starting on page 85 for key function descriptions.

The name editor menu is shown separately, though it is accessed when entering data for many keys. The front-panel key menus appear in alphabetical order as follows.



# Amplitude Menu

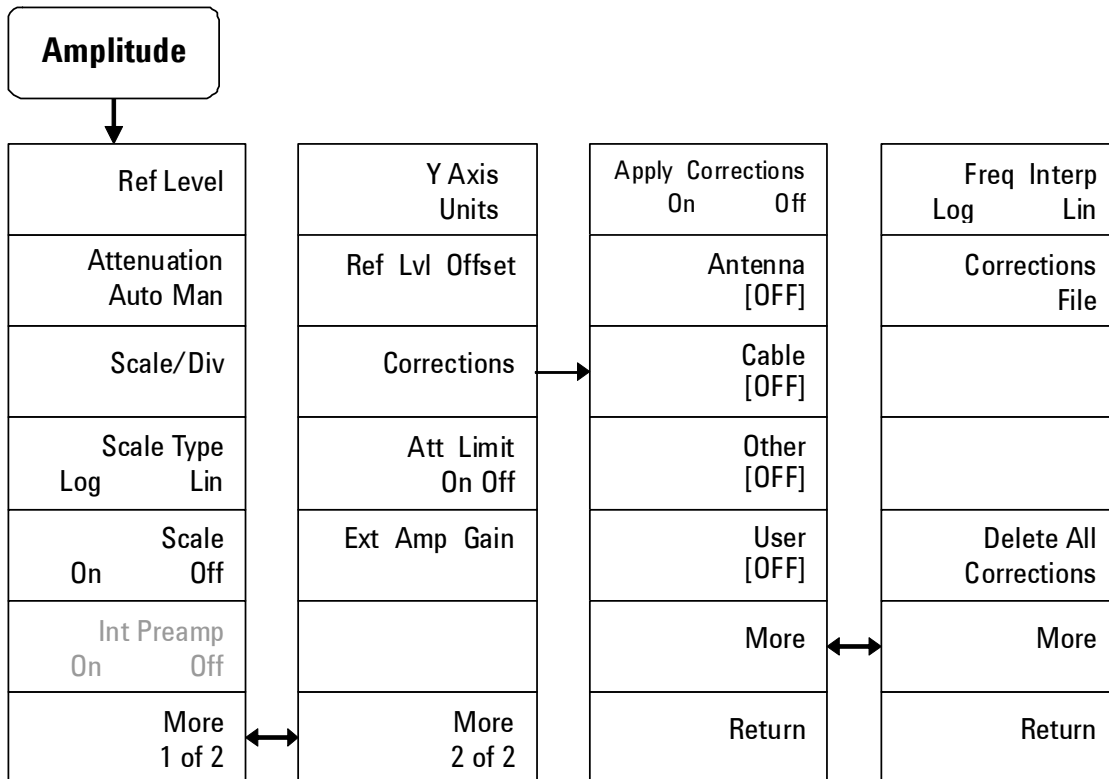



## BW/Avg Menu

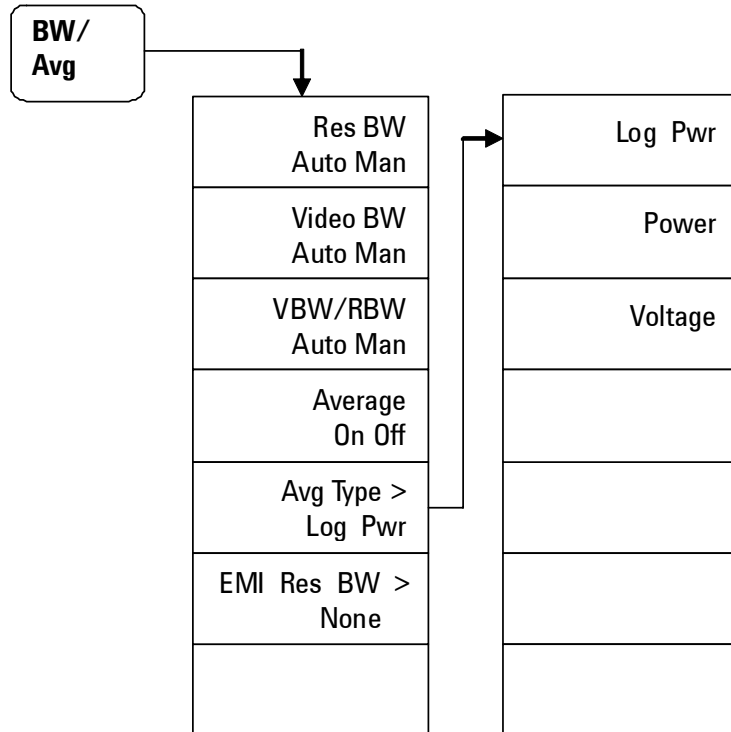

## Det/Display Menu

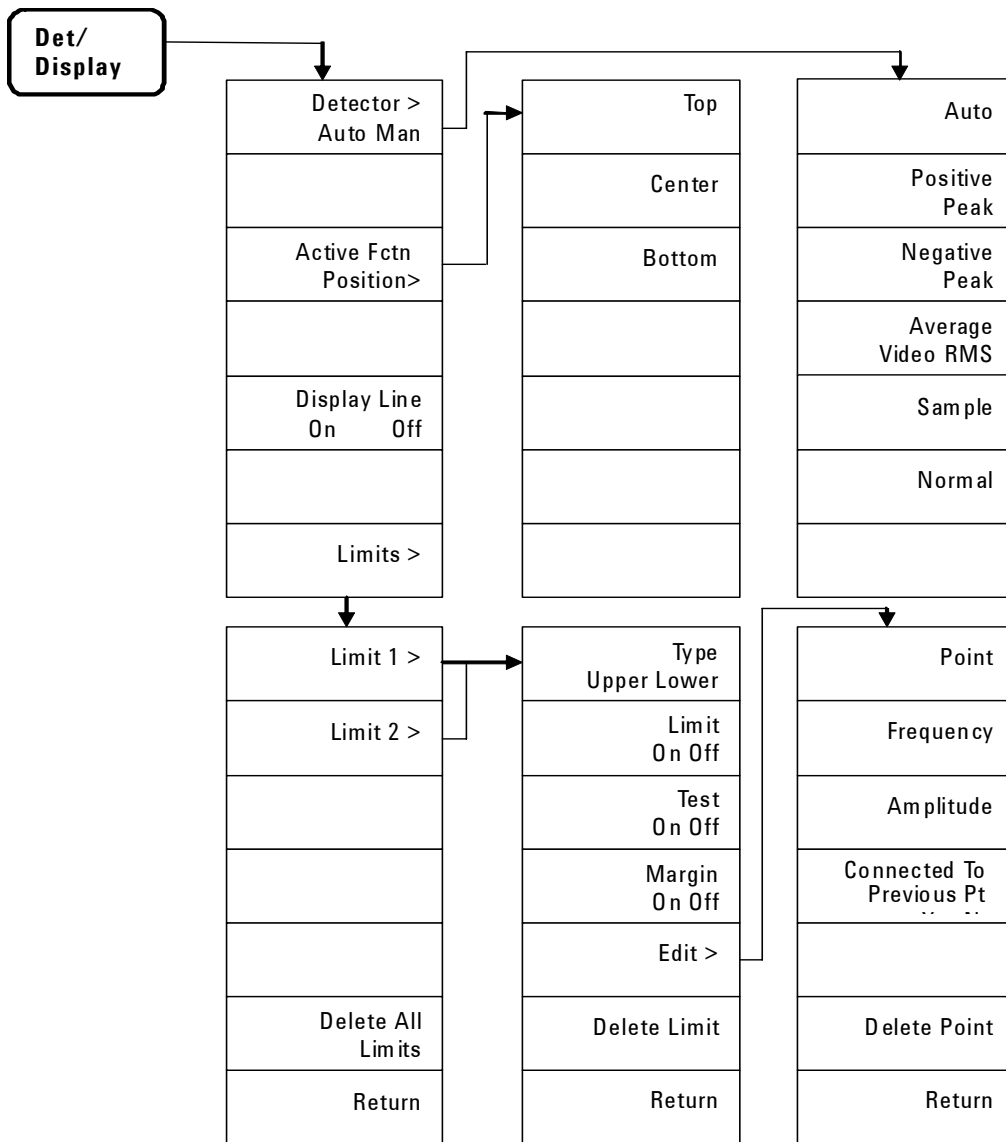

## File Menu (1 of 2)

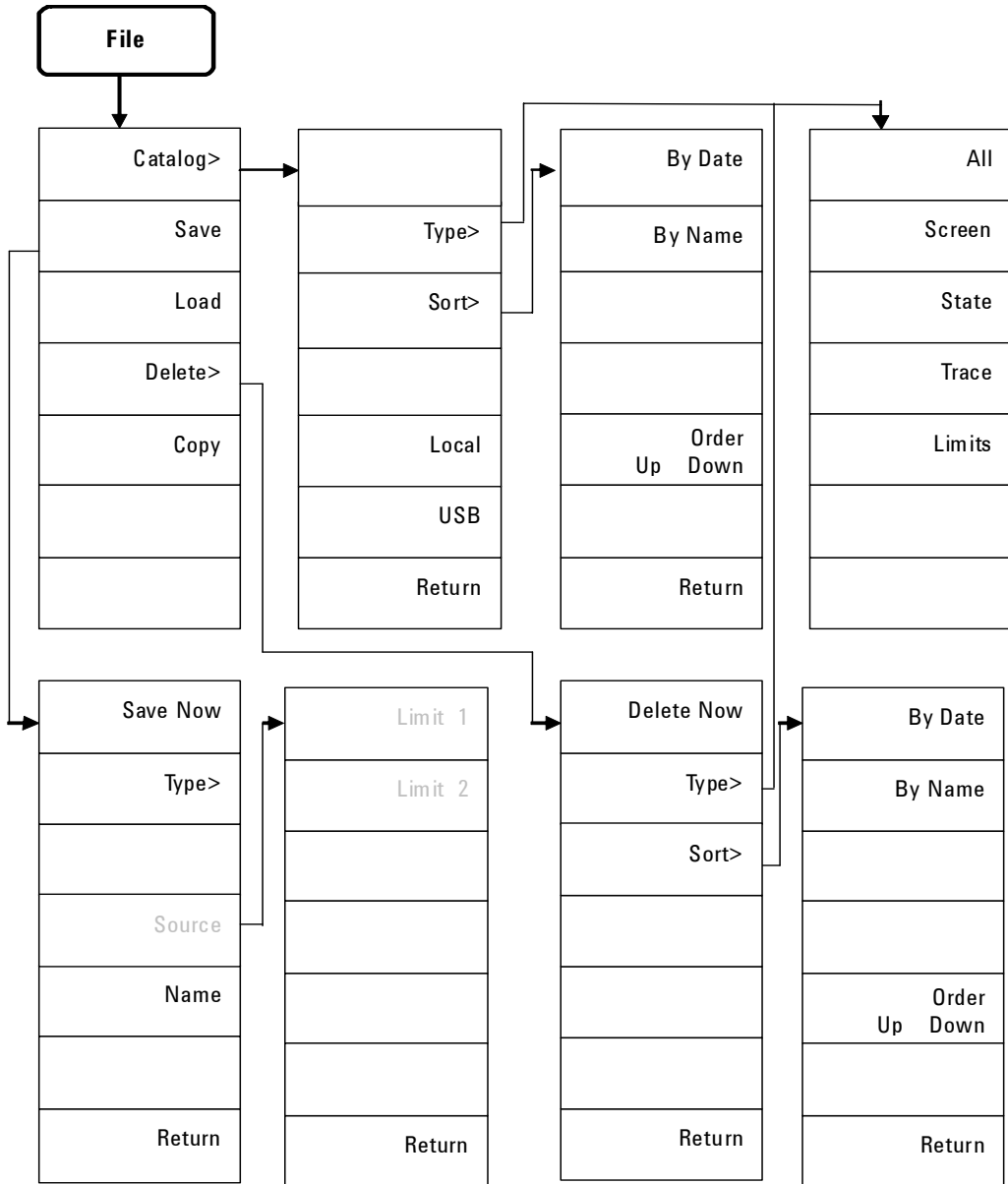

## File Menu (2 of 2)

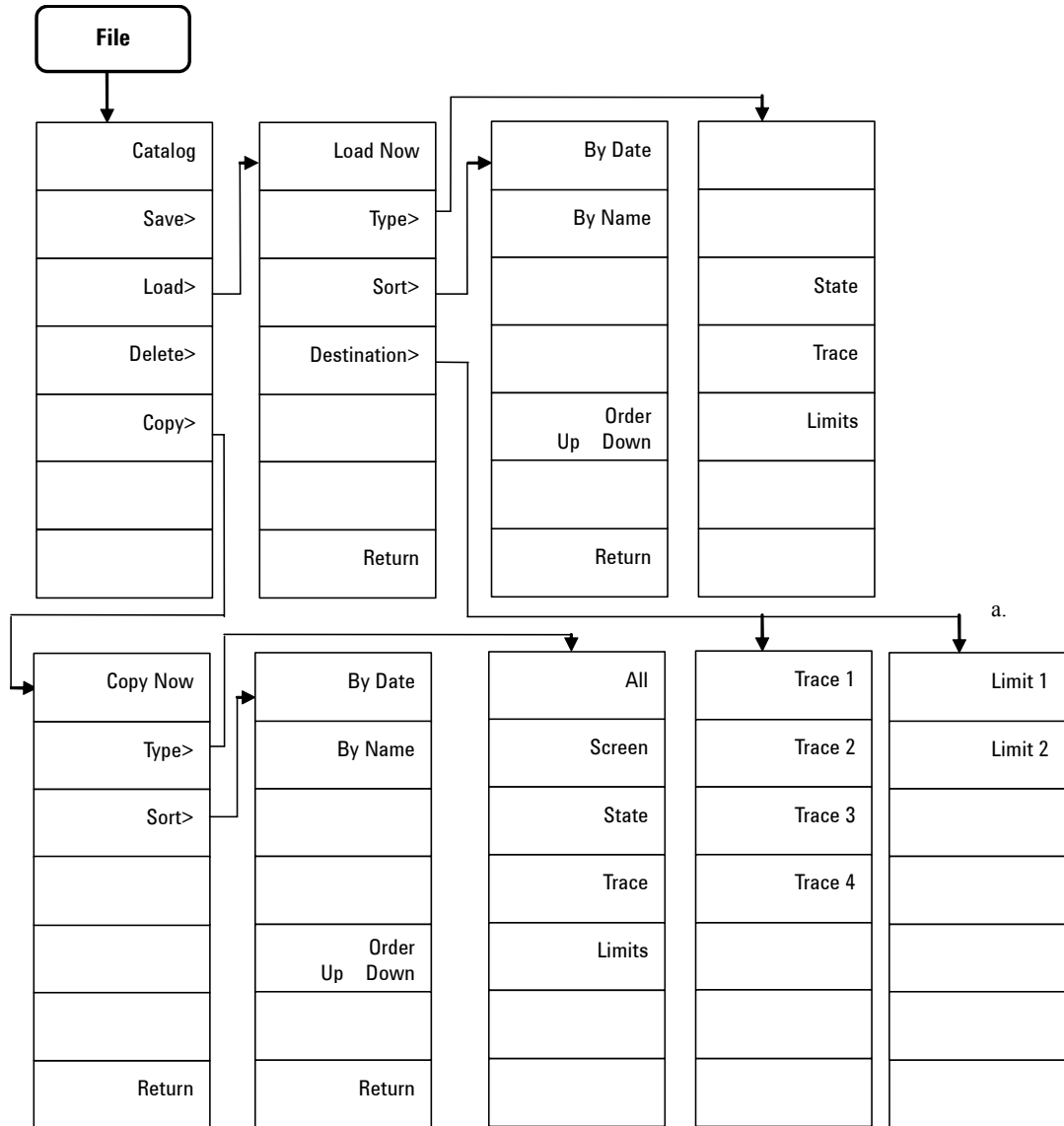

a. This menu is only available for the trace file.

## Frequency Menu

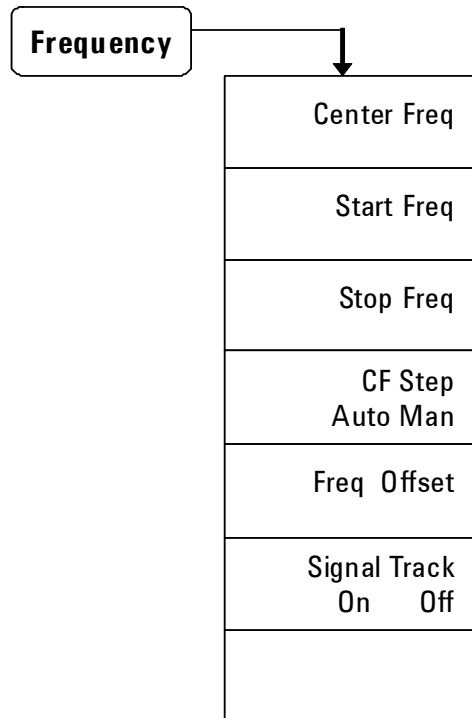

# Marker Menu

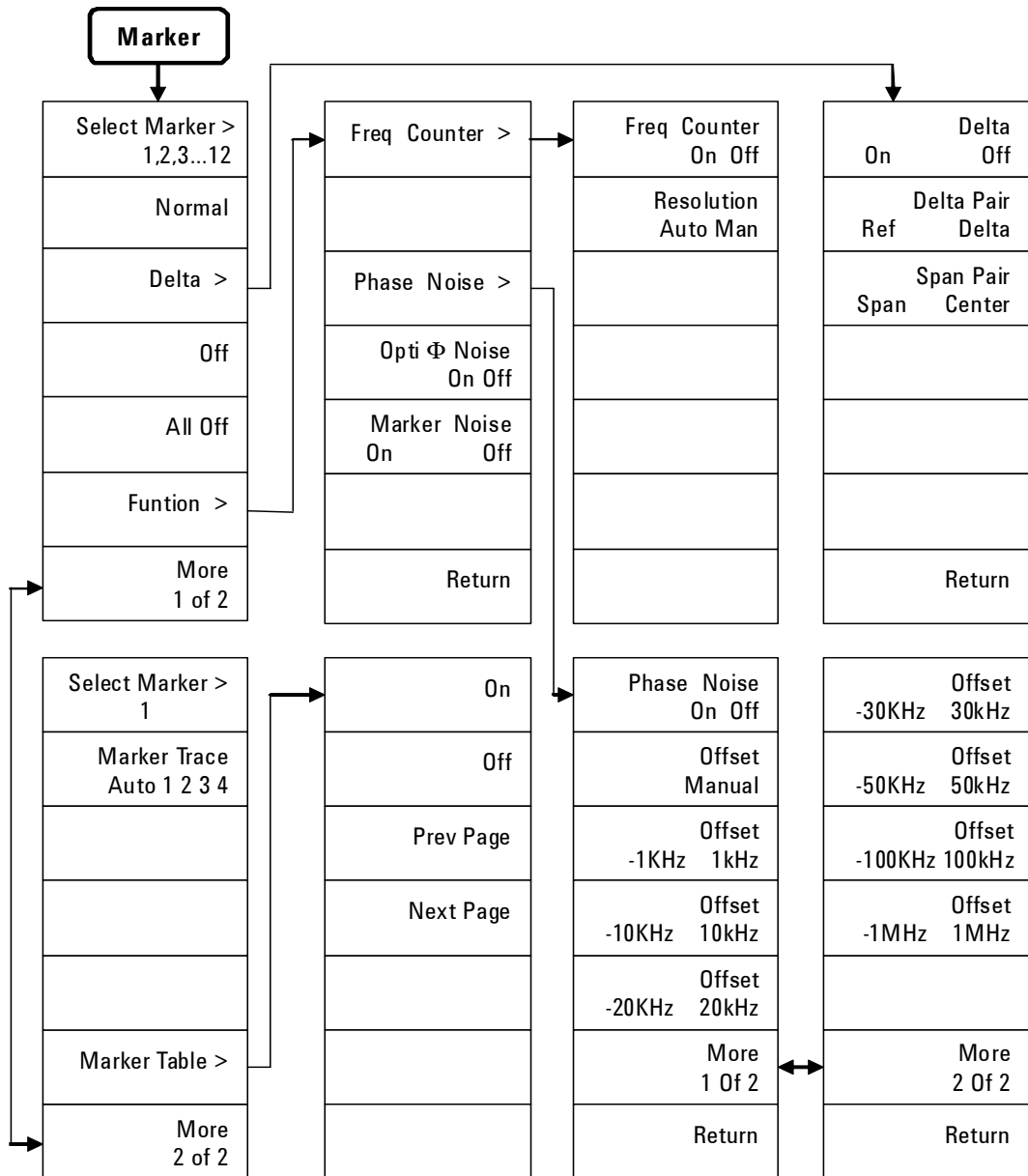

## Marker-> Menu

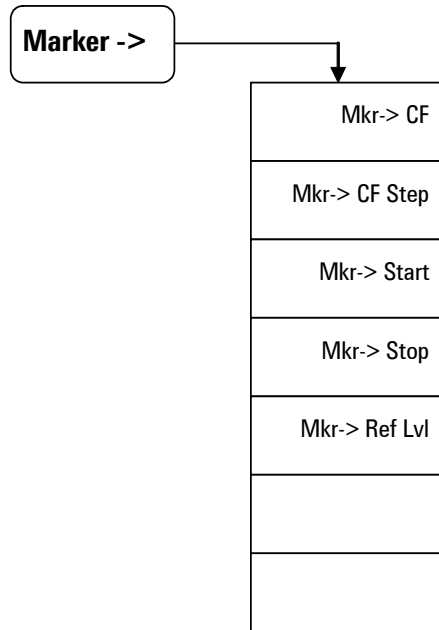

# Measure Menu (1 of 2)

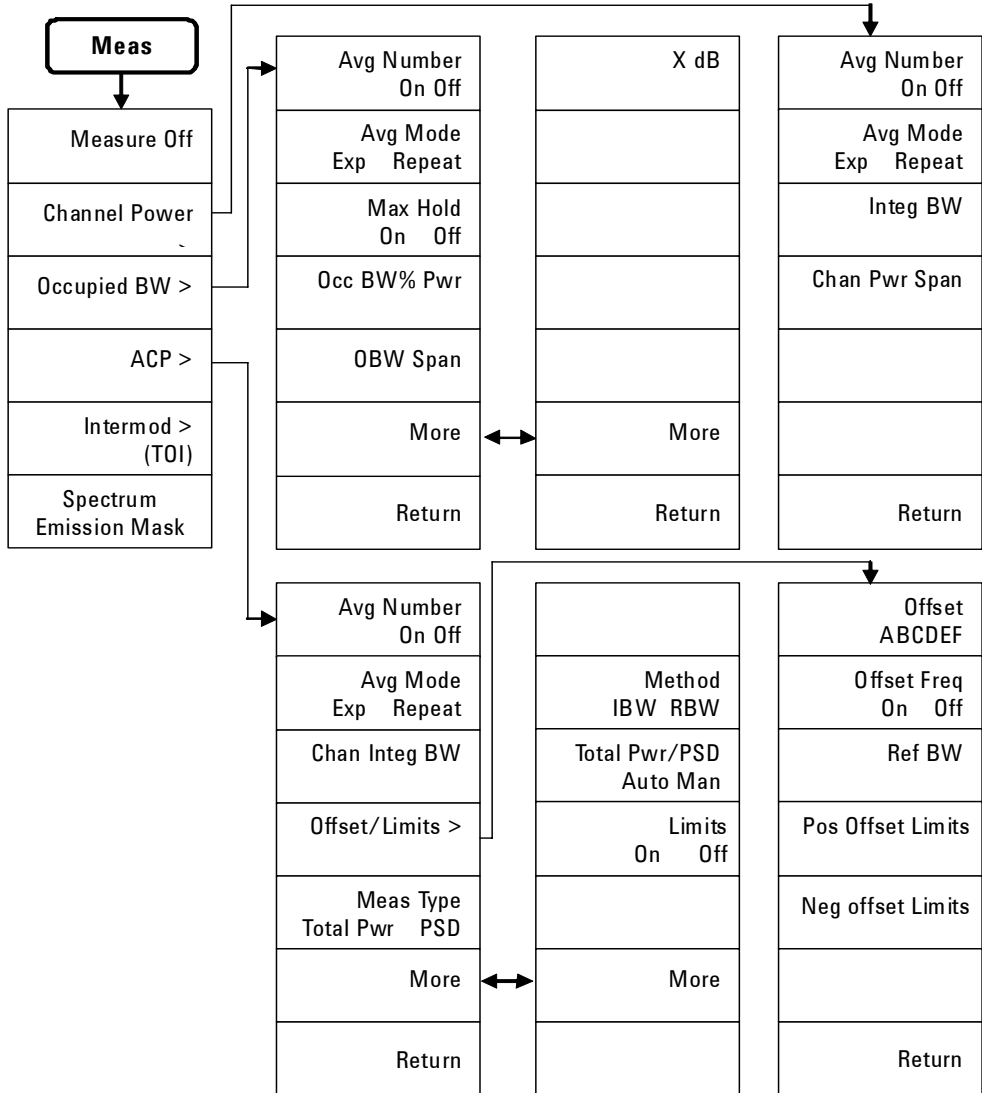

a. Continued on sheet 2 of 2



## Measure Menu (2 of 2)

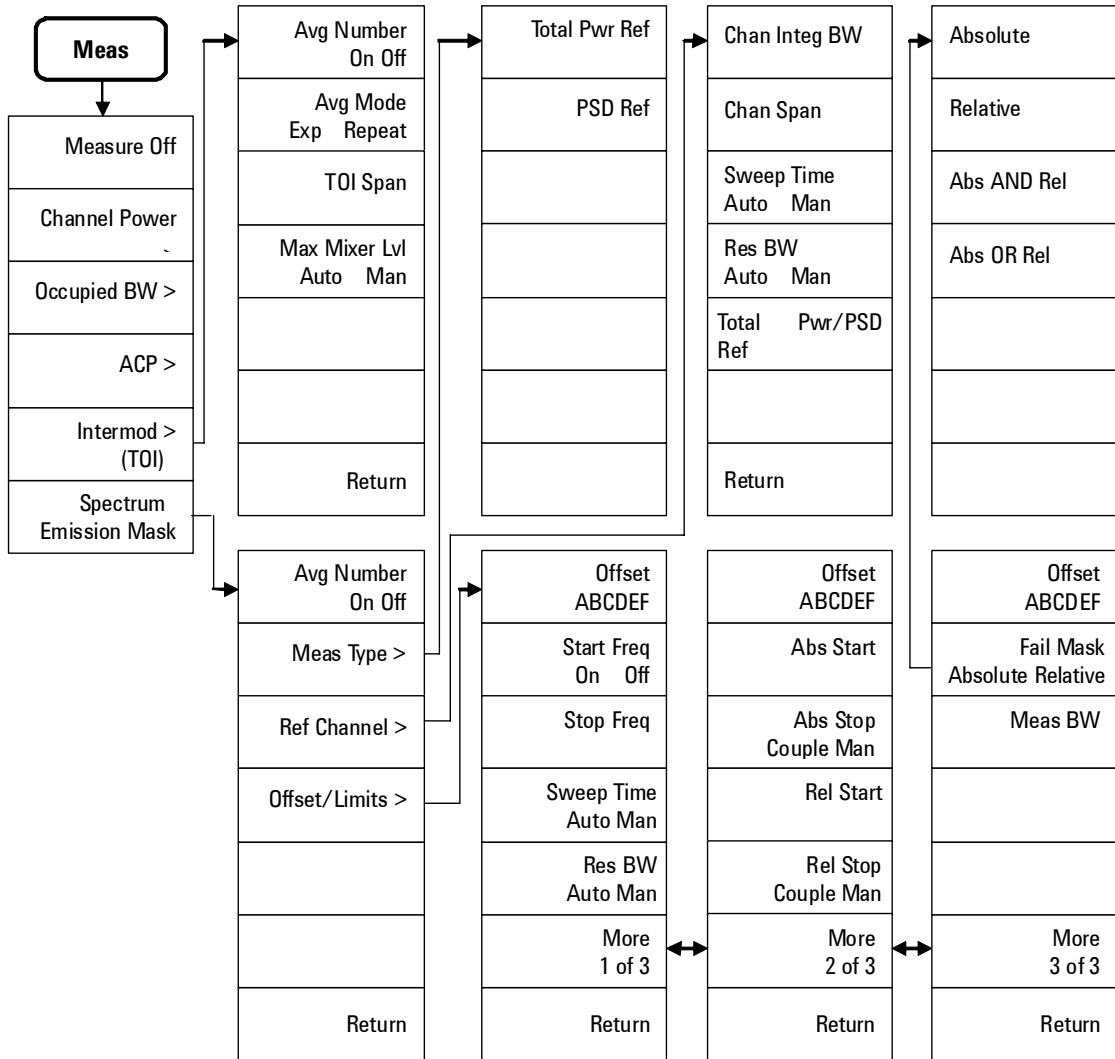

# MODE - Tracking Generator

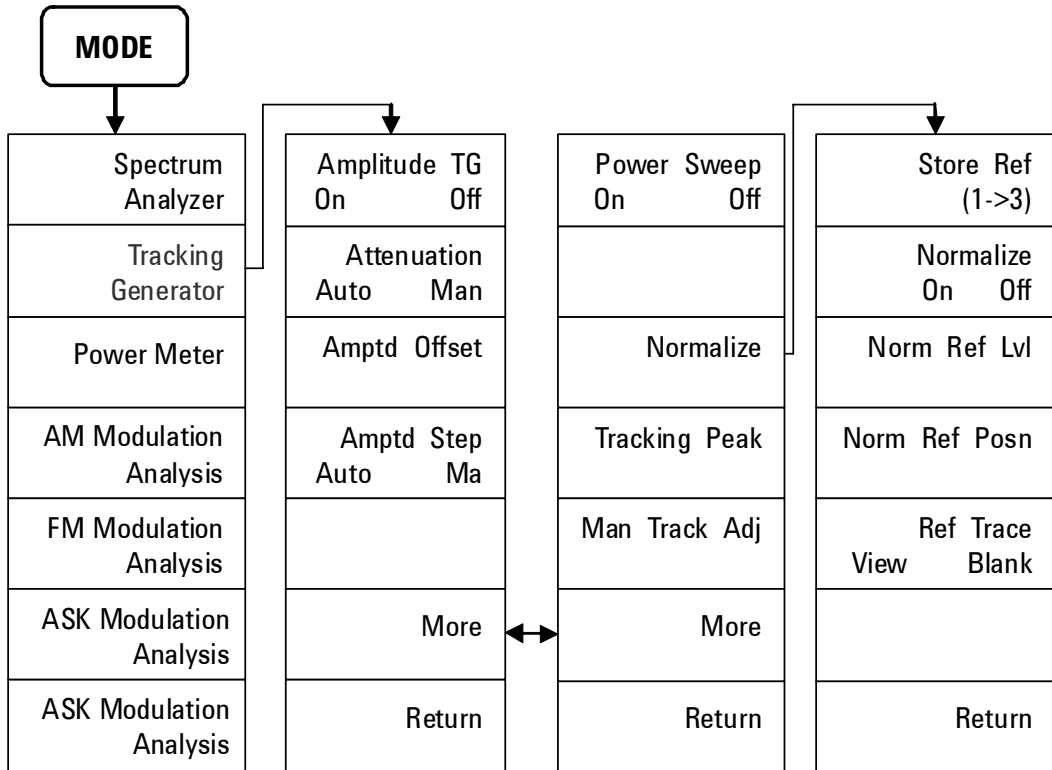

# MODE - Power Meter

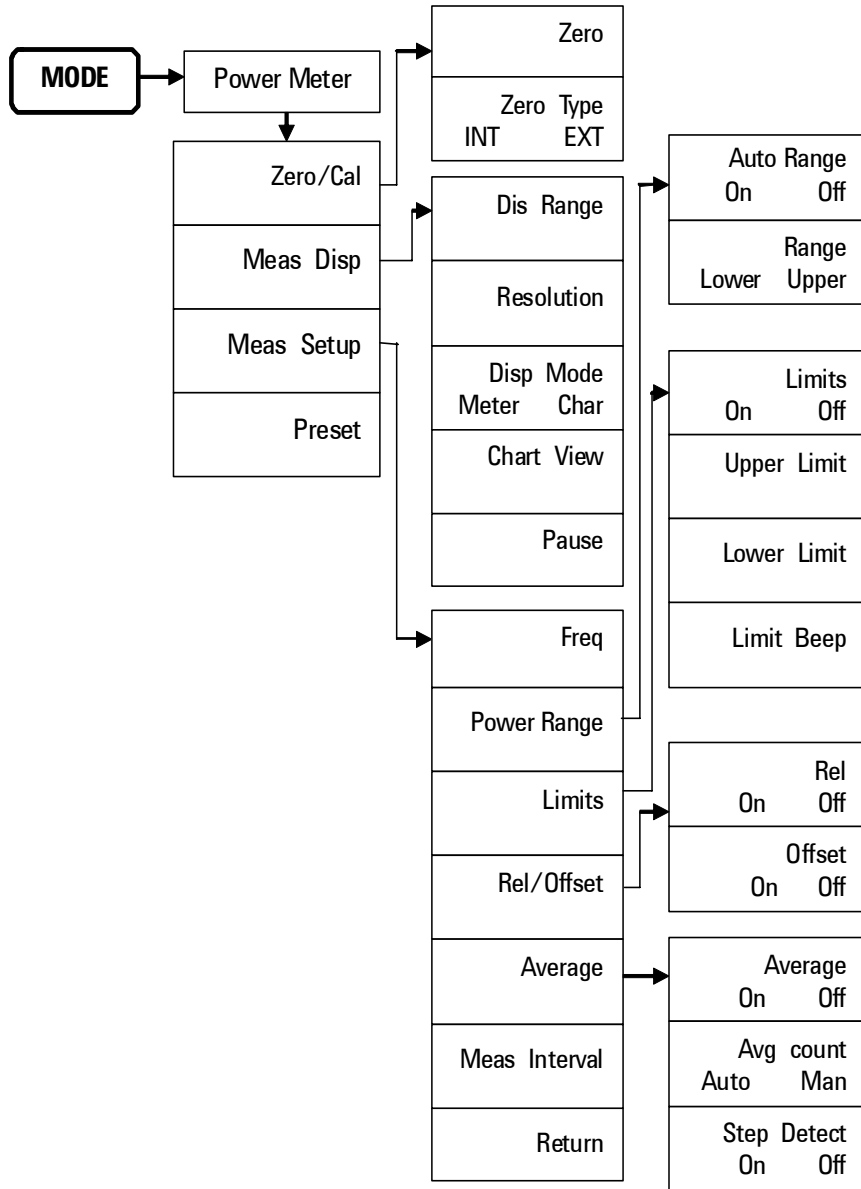

## MODE - AM/FM Modulation Analysis

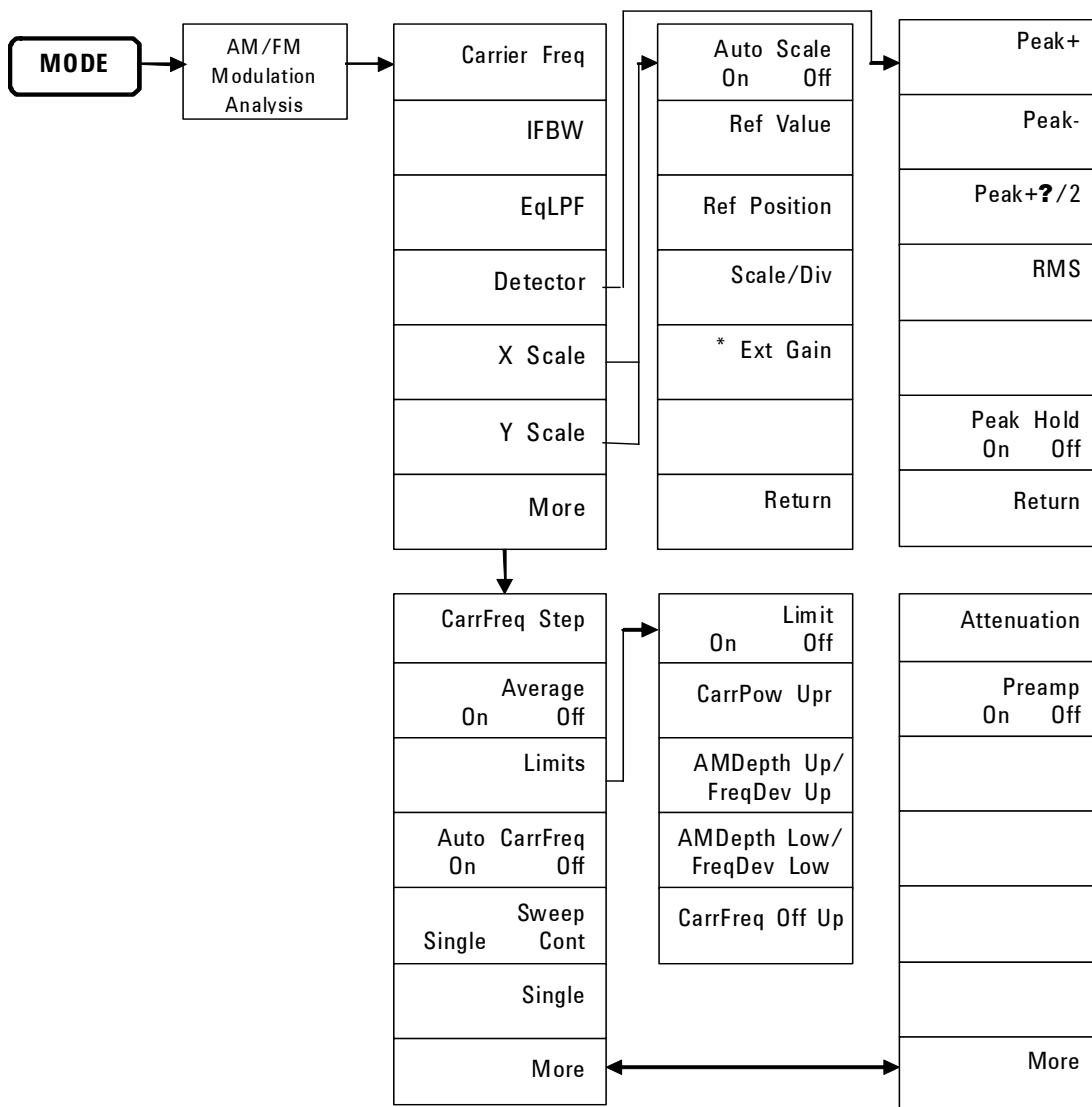

\* **Ext Gain** is only available in **Y Scale** submenu.

# MODE - ASK/FSK Modulation Analysis

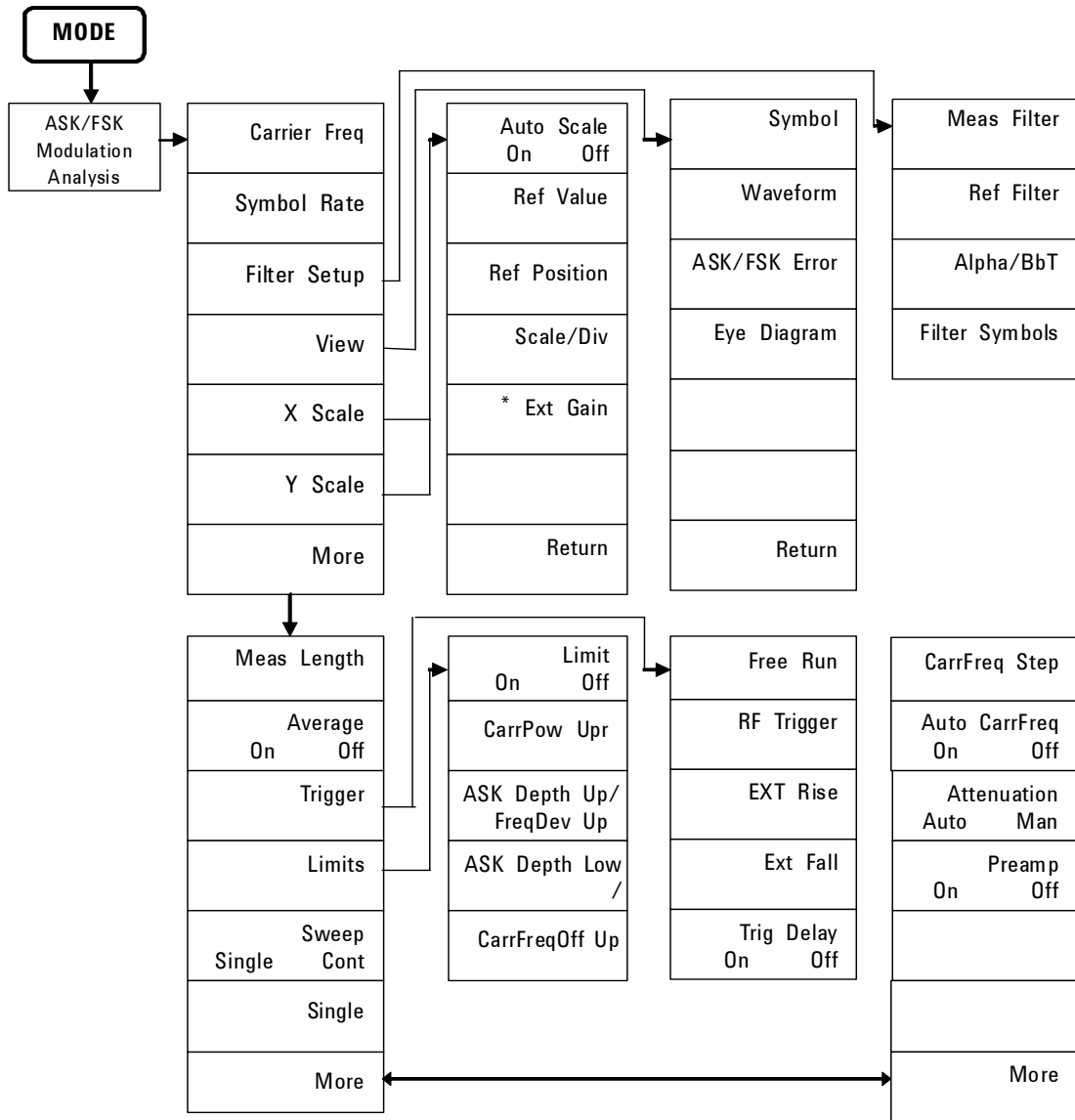

\* **Ext Gain** is only available in **Y Scale** submenu.

## Name editor Menu

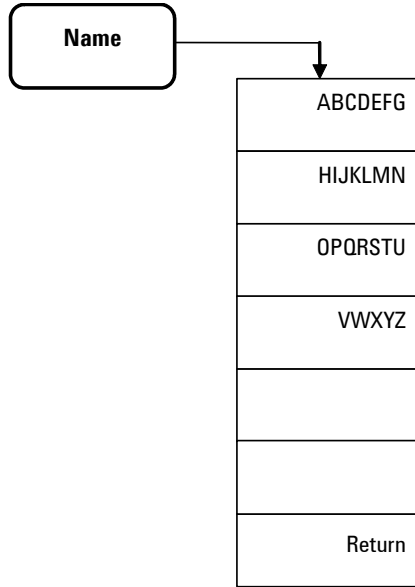

# Peak Search Menu

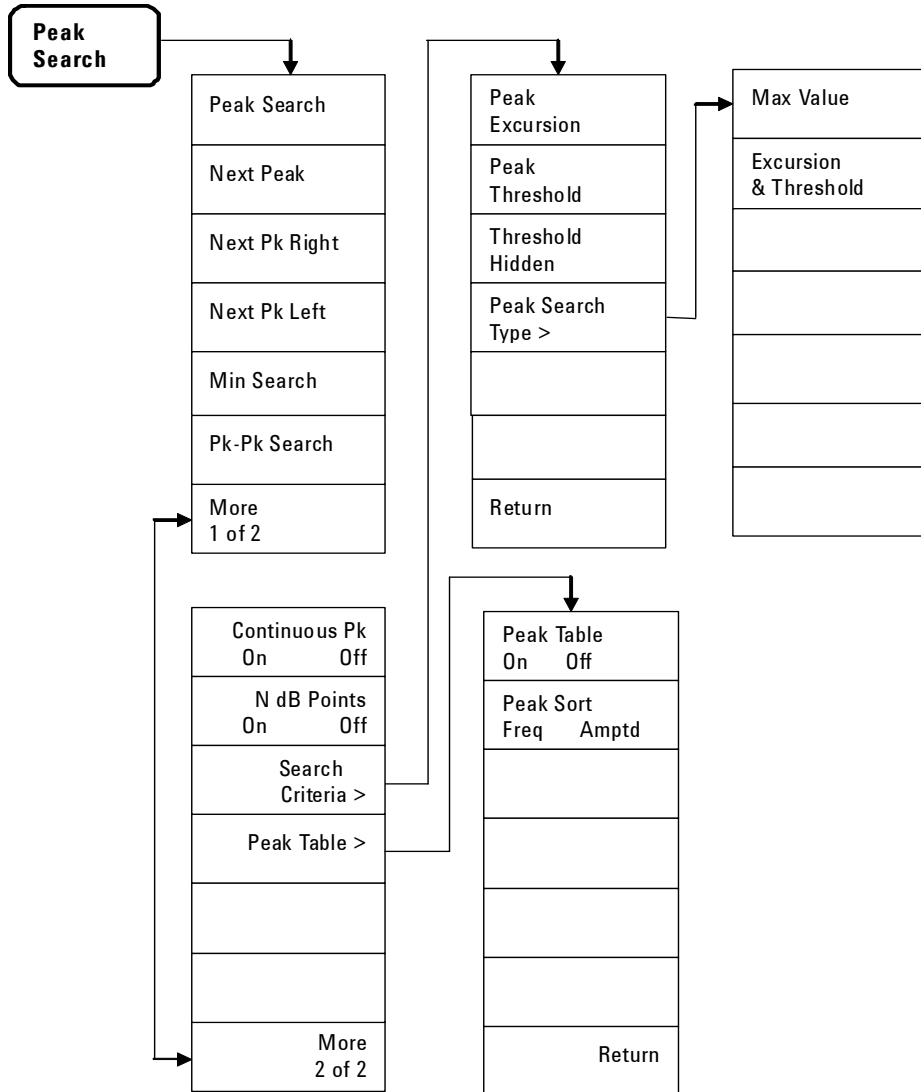

# Preset/System Menu

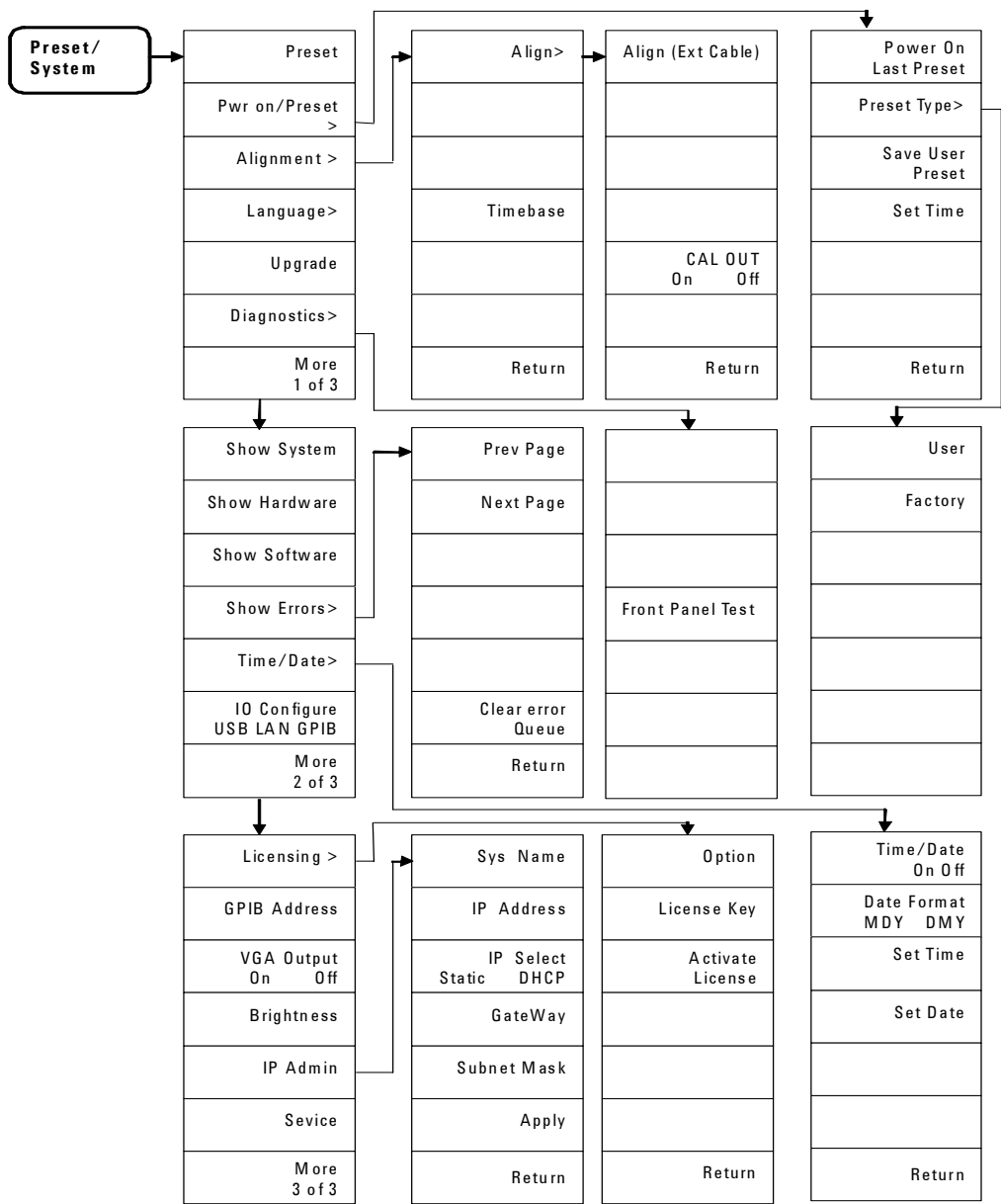



# SPAN Menu

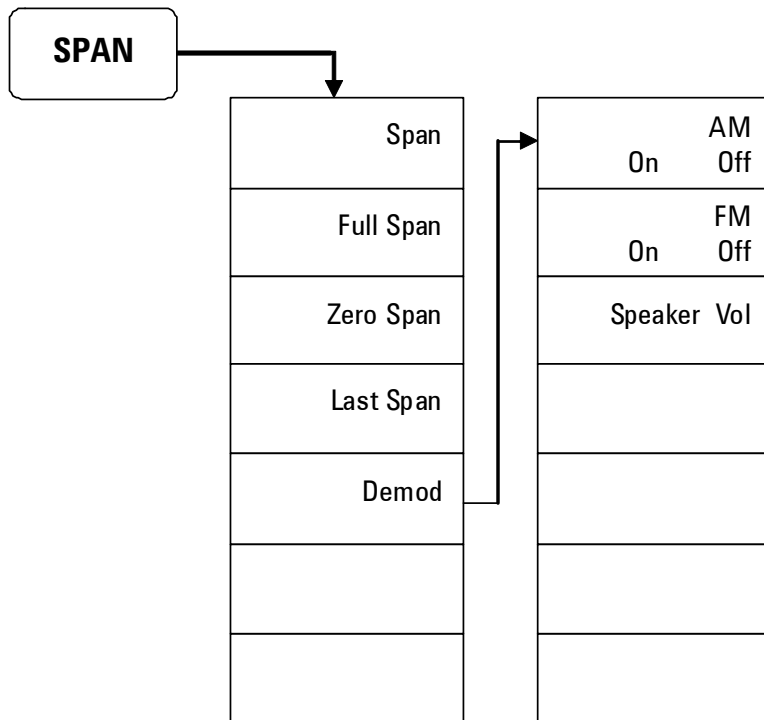

# Sweep/Trig Menu

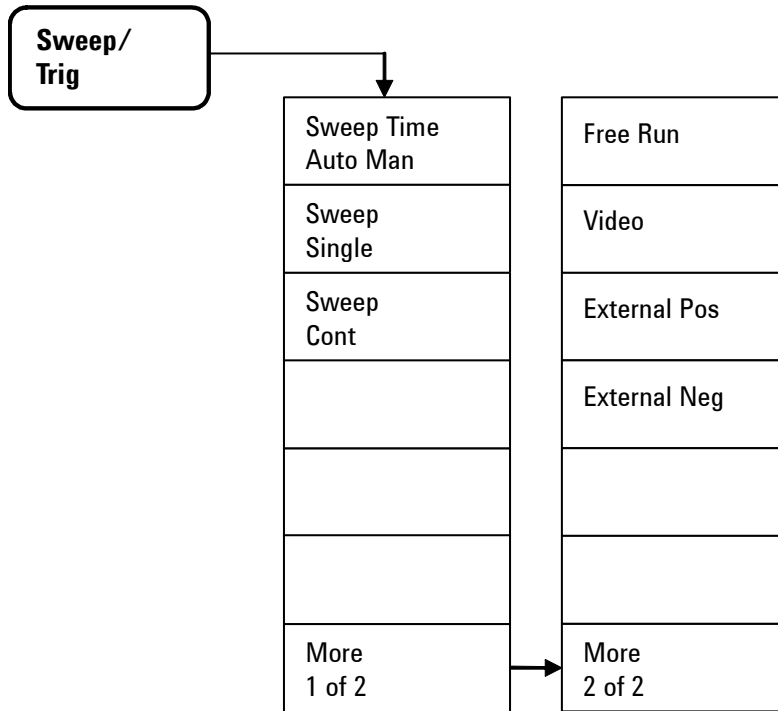

## View/Trace Menu

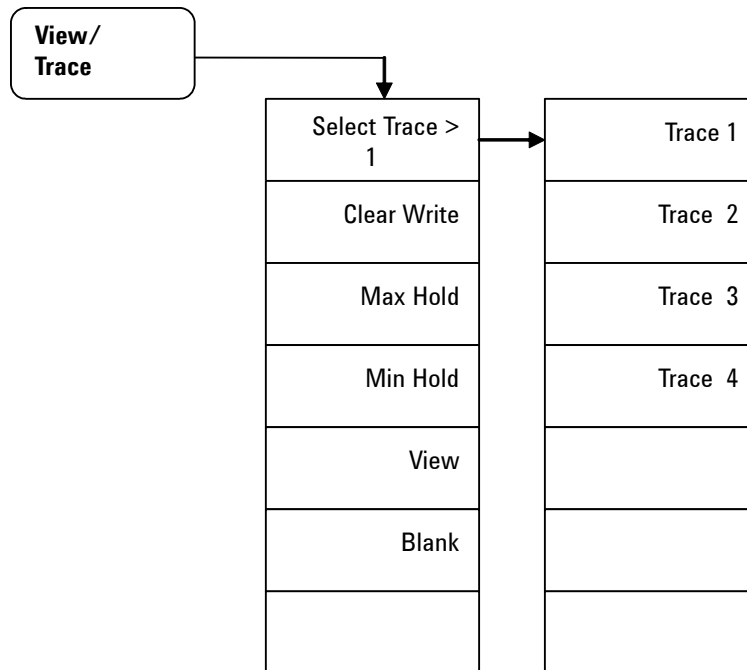



# Index

## Numerics

3GPP W-CDMA, 128  
802.11a, 129  
802.11b, 130

## A

Abs Start, 131  
Abs Stop, 131  
Active Fctn Position, 97  
adjacent channel power, 121  
Alignment, 150  
    running, 18  
Amplitude key, 86  
annotation, marker, 31  
Attenuation, 86  
attenuation, reducing, 41  
Auto Tune key, 5, 89  
Average, 93

## B

Back, 90  
BW/Avg key, 91

## C

Catalog, 102  
CE mark, 10  
Center Freq, 107  
CF Step, 107  
channel power, 116  
comparing signals  
    off screen, 34  
    on the screen, 32  
Continuous PK, 145  
Copy, 106

CSA mark, 10  
c-tick mark, 10

## D

Delete, 105  
delta marker, 109  
Det/Display key, 95  
Detector, 95  
Display Line, 97, 98  
distortion, measuring, 50

## E

Enter key, 101  
error message, 18  
ESD, 22  
external reference, 23, 24

## F

factory preset state, 149  
Fail Mask, 131  
File key, 102  
firmware revision, update, 24  
frequency counter, 111  
front panel  
    overview, 4  
front panel, using, 28

## H

harmonic distortion  
    measuring, 50

## I

improving frequency resolution and  
    accuracy, 46

instruction manual, 10  
instrument messages, 159  
Int Preamp, 87  
ISM1-A, 10

## L

Licensing, 152  
Limits, 98  
Load, 104

## M

Marker key, 109  
Marker Table, 114  
Marker-> key, 115  
Max Mixer lvl, 125  
Meas key, 116  
measuring  
    ACP, 121  
    channel power, 116  
    distortion, 50  
    low-level signal, 41  
    multiple signals, 32  
    occupied BW, 118  
    SEM, 126  
    source's frequency drift, 48  
    TOI, 53, 124  
measuring phase noise, 56  
menu maps, 173  
messages, 18  
Min Search, 145  
MODE key, 133

## N

N dB Points, 145  
Next Peak, 144

## Index

### O

occupied BW, 118  
Offset/Limits, 122, 128  
options, 13  
    enable, 24  
    licensing, 152  
order list, 12

### P

Peak Search key, 144  
Peak Table, 147  
Phase Noise, 111  
phase noise, measuring, 56  
power cord, 15  
power requirements, 15  
Preset, 148  
preset  
    factory, 29  
    user, 29  
Preset/System key, 148  
Pwr on/Preset, 150

### R

rack mount, 20  
Ref level, 86  
Rel Start, 131  
Rel Stop, 131  
requirements  
    ventilation, 19  
Res BW, 91  
resolving signals  
    equal amplitude, 36  
    hidden by large signals, 39

### S

Save, 103  
Scale/Div, 86  
Search Criteria, 145  
Show System, 151  
Signal Track, 108  
SPAN key, 154

spectrum emission mask, 126  
Start Freq, 107  
Stop Freq, 107  
Sweep/Trig key, 156  
symbols, 10

### T

Threshold Hidden, 146  
TOI  
    Meas key, 124  
    measuring, 53  
TOI Span, 125  
tracking drifting signals, 48

### U

Uncoupled, definition, 44  
using frequency counter, 46

### V

VBW/RBW, 92  
ventilation, 19  
Video BW, 91  
View/Trace key, 158  
viewing signal, 30

### W

WEEE, 10



**Manufacturer's Name:** Agilent Technologies (Chengdu) Co., Ltd.

**Manufacturer's Address:** No. 116, 1st Street Tuo Xin West  
Chengdu Hi-Tech Industrial Development Zone (South),  
Chengdu, 610041, China

**Declares under sole responsibility that the product as originally delivered**

**Product Name:** Spectrum Analyzer

**Model Number:** N9320B

**Product Options:** This declaration covers all options of the above product(s)

**complies with the essential requirements of the following applicable European Directives, and carries the CE marking accordingly:**

Low Voltage Directive 2006/95/EC  
EMC Directive 2004/108/EC

**and conforms with the following product standards:**

<b>EMC</b>	<b>Standard</b>	<b>Limit</b>
	IEC 61326-2-1:2005 / EN 61326-2-1:2006	
	<i>Reference Standards</i>	
	CISPR 11:2003 / EN 55011:2007	Class A Group 1
	IEC 61000-4-2:2001 / EN 61000-4-2	4 kV/4 kV contact/air
	IEC 61000-4-3:2002 / EN 61000-4-3	3 V/m, 80-2000 MHz, 1 V/m, 2-2.7 GHz
	IEC 61000-4-4:2004 / EN 61000-4-4	0.5 kV signal lines, 1 kV power lines
	IEC 61000-4-5:2001 / EN 61000-4-5	0.5 kV line-line, 1 kV line-ground
	IEC 61000-4-6:2003 / EN 61000-4-6	3 V, 0.15-80 MHz
	IEC 61000-4-11:2004 / EN 61000-4-11	1 cycle, >95%

Canada: ICES/NMB-001:2006  
Australia/New Zealand: AS/NZS CISPR 11:2004

The product was tested in a typical configuration with Agilent Technologies test systems.

**Safety**  
IEC 61010-1:2001 / EN 61010-1:2001  
Canada: CAN/CSA-C22.2 No. 61010-1-04,  
USA: ANSI/UL 61010-1:2004,

**Supplementary Information:**

**This DoC applies to above-listed products placed on the EU market after:**

Sep 28, 2009  
Date

**Shi Wen**  
Quality Manager

For further information, please contact your local Agilent Technologies sales office, agent or distributor,  
or Agilent Technologies Deutschland GmbH, Herrenberger Straße 130, D 71034 Böblingen, Germany.

[www.agilent.com](http://www.agilent.com)

© Agilent Technologies, Inc. 2008-2009

Printed in China  
Second Edition, Oct 2009



**N9320-90007**

